

MSA Series

Micro Hall Effect thumb controller

MAIN FEATURES

- Micro size
- Spring centering, single axis operation
- Proportional output
- IP67 above panel sealing
- 3 million lifecycles
- Return to center voltage +/-50mV
- Made in the USA



The MSA Series is a single axis, Hall effect thumb controller. Designed for both control grip and panel mount applications, the “micro” size allows for multiple MSAs to fit adjacent to one another. The MSA is available with a one piece elastomer actuator that offers a combination of premium user feel with IP67 above panel sealing. The MSA ships with an under panel mounting clip and a multi-conductor mating wire harness.

SPECIFICATIONS*

MECHANICAL SINGLE AXIS	
Angular travel:	50° total (25° each direction from center)
Expected life:	3 million operations
Centering:	Spring return
Mass/weight:	15 grams**
Maximum vertical load:	50 lbF
Maximum horizontal load:	50 lbF***

* Specifications subject to change without notice

** Approximate weight. Actual weight dependent on configuration

*** Measured 0.44" above surface

04292024mp



MSA Series

Micro Hall Effect thumb controller

SPECIFICATIONS

ELECTRICAL	
Technology:	Hall effect sensor, single or dual
Resolution:	12 bit
Supply voltage:	5.00VDC +/- 0.01VDC regulated, transient free
Supply current:	20mA max
Ratiometric output voltage:	See options
Return to center voltage tolerance:	+/-50mV
Transient overvoltage max:	20VDC
Reverse polarity max:	-10VDC
Output impedance:	2Ω
Start up time:	15ms max

ENVIRONMENTAL	
Operating temperature:	-40°C +85°C
Storage temperature:	-40°C +85°C
Above panel sealing:	IP67*
EMC immunity level:	EN61000-4-3** Compliance to 30A/m
EMC emissions level:	EN61000-6-3
ESD immunity level:	EN61000-4-2** Compliance to +/-15kV/+/-8kV
Vibration:	Per SAE J1455 Section 4.9 & MIL-STD810G 514.6
Mechincal shock:	Per SAE J1455 Section 4.10 & MIL-STD-202G

* Above panel sealing. All configurations. Product is idle and not in use.

** Extended testing levels

04292024mp





MSA Series

Micro Hall Effect thumb controller

SPECIFICATIONS

MATERIALS	
Housing:	Mineral & glass filled nylon
Boots:	Silicone (with tear resistant additive)
Actuators:	Silicone or mineral & glass filled nylon

04292024mp

Ruffy Controls, Inc.
3258 Grey Hawk Ct., Carlsbad, CA 92010
ruffycontrols.com

For more information: sales@ruffycontrols.com

**SCAN TO
ORDER TODAY**



MSA Series

Micro Hall Effect thumb controller

CONNECTIONS

PIN #*	WIRE COLOR**	DESCRIPTION	Single Output
1	N/A	N/A	
2	YELLOW	SENSOR	
3	BLACK	GROUND	
4	RED	POWER (+5V)	

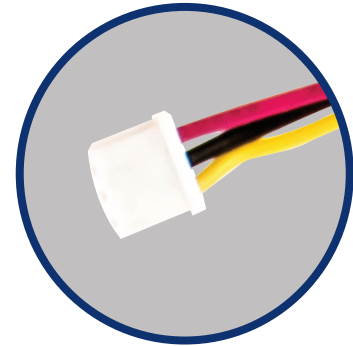

***Housing body:** Molex four position PCB header: 53047-0410

****Mating wire harness:** 10" 28AWG PTFE to four position connector housing:
Molex: 0510210400

PIN #*	WIRE COLOR**	DESCRIPTION	Dual Output
1	GREY	SENSOR 2	
2	RED	+5V SENSOR 1	
3	YELLOW	SENSOR 1	
4	PINK	+5V SENSOR 2	
5	BLACK	GROUND	

***Housing body:** Molex five position PCB header: 53047-0510

****Mating wire harness:** 10" 28AWG PTFE to five position connector housing:
Molex: 0510210500

04292024mp



MSA Series

Micro Hall Effect thumb controller

MSA SERIES PART NUMBER CODE

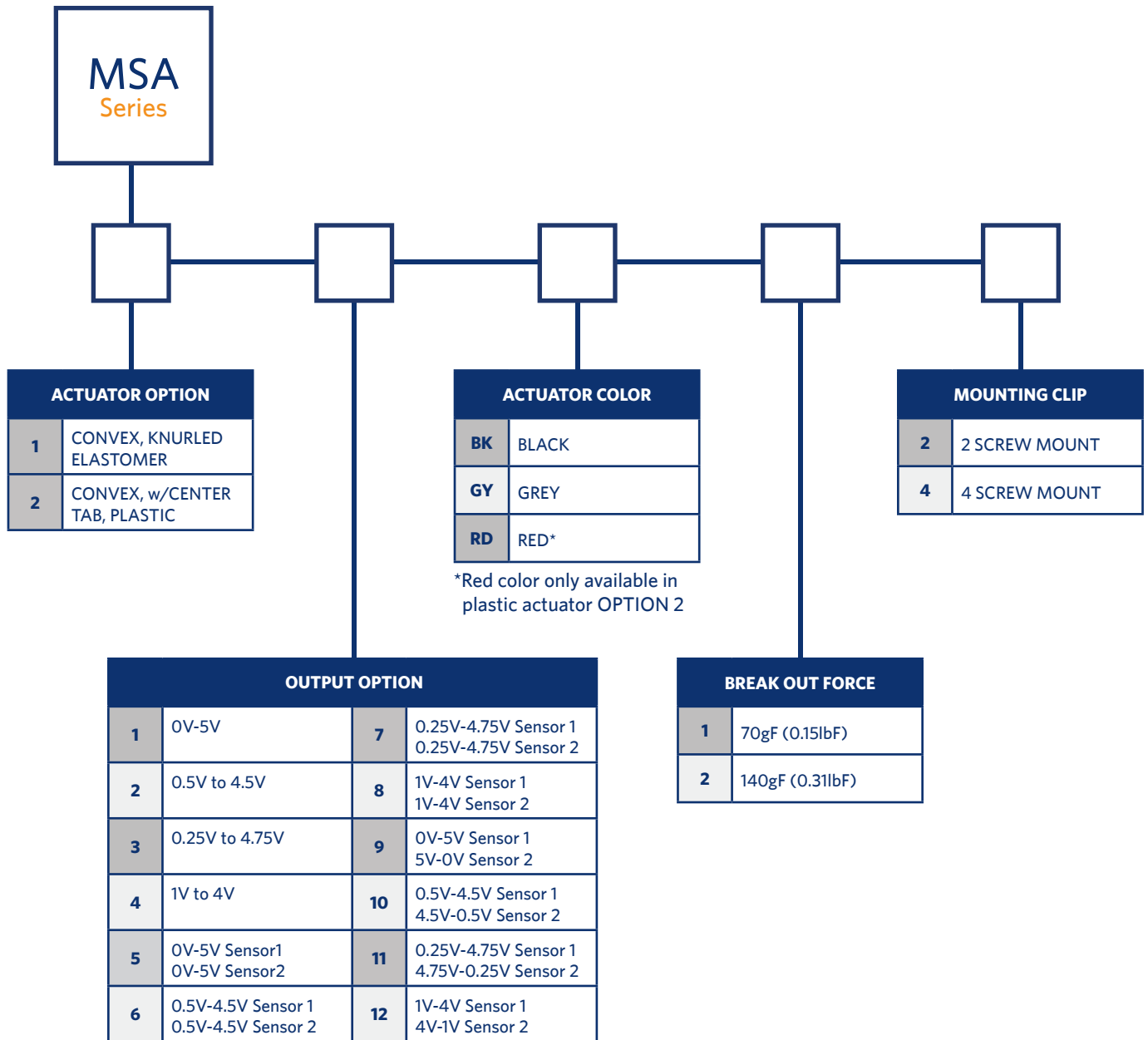

04292024mp



MSA Series

Micro Hall Effect thumb controller

ACTUATOR OPTION



OPTION 1
Convex, knurled elastomer

OPTION 2
Convex, w/center tab, plastic

04292024mp



MSA Series

Micro Hall Effect thumb controller

VOLTAGE OUTPUT OPTIONS

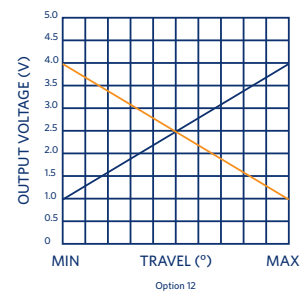
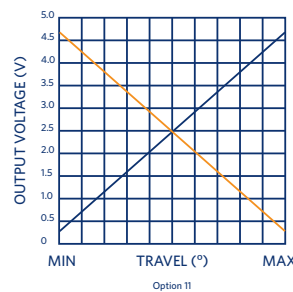
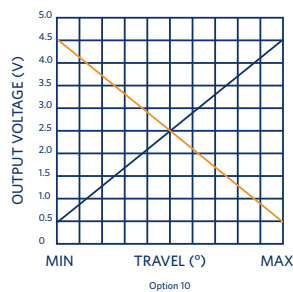
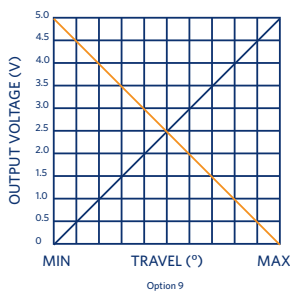
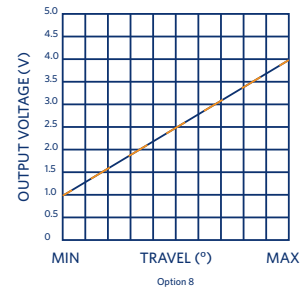
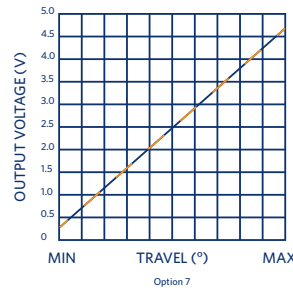
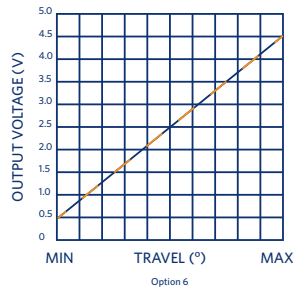
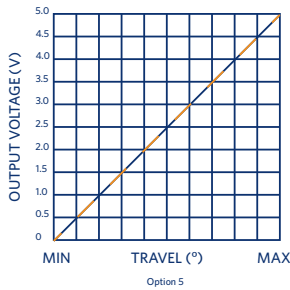
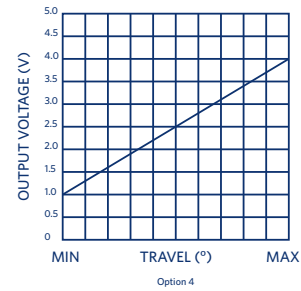
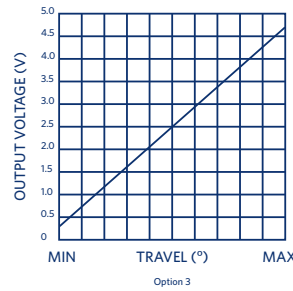
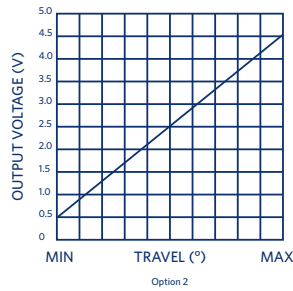
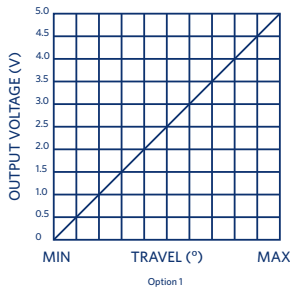

04292024mp

Ruffy Controls, Inc.
3258 Grey Hawk Ct., Carlsbad, CA 92010
ruffycontrols.com

For more information: sales@ruffycontrols.com

SCAN TO
ORDER TODAY



MSA Series

Micro Hall Effect thumb controller

MOUNTING PANEL DIMENSIONS

CONVEX, KNURLED
ELASTOMER ACTUATOR

2 SCREW MOUNTING CLIP

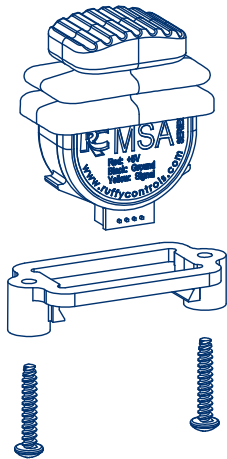

4 SCREW MOUNTING CLIP

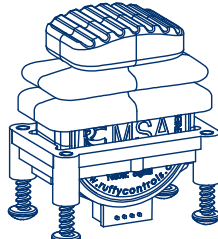
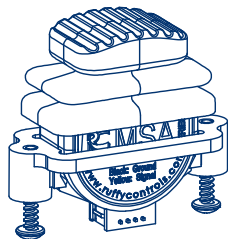
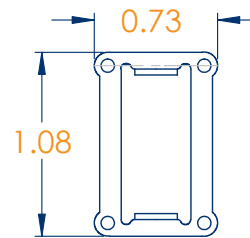
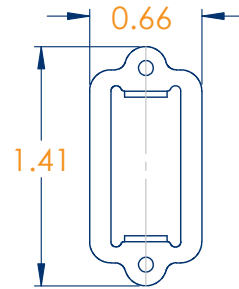
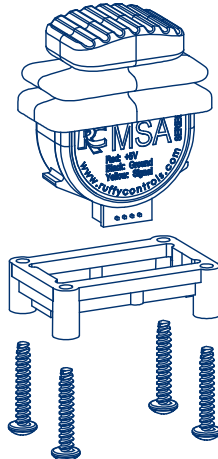

PANEL CUTOUT DIMENSIONS
(PANEL THICKNESS UP TO 0.125")

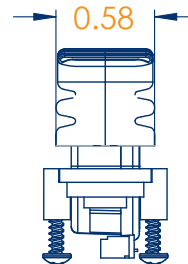
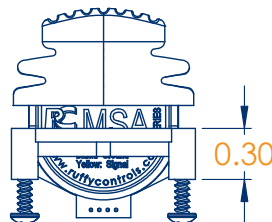
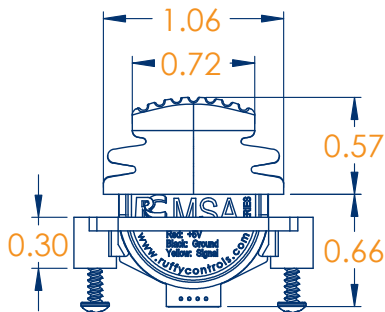
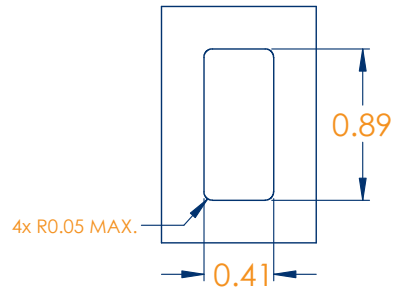

04292024mp



MSA Series

Micro Hall Effect thumb controller

MOUNTING PANEL DIMENSIONS

CONVEX, KNURLED
PLASTIC ACTUATOR

2 SCREW MOUNTING CLIP

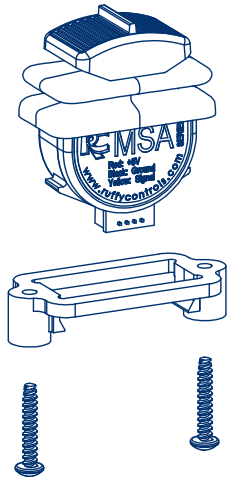

4 SCREW MOUNTING CLIP

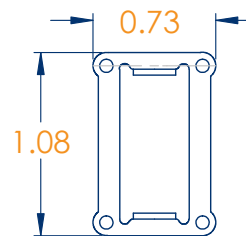
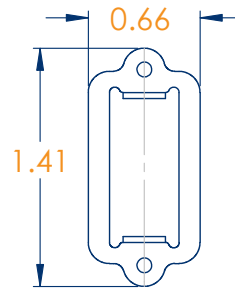
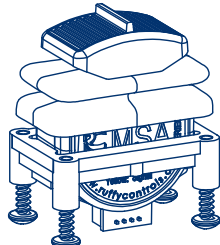
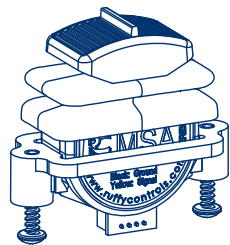
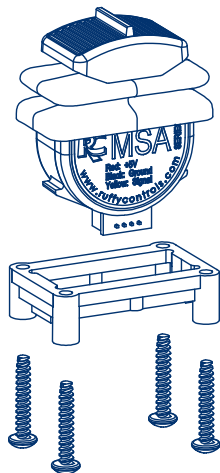

PANEL CUTOUT DIMENSIONS
(PANEL THICKNESS UP TO 0.125")

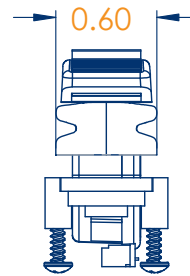
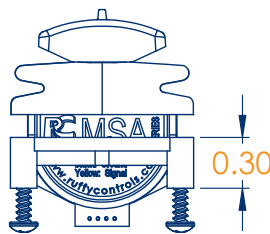
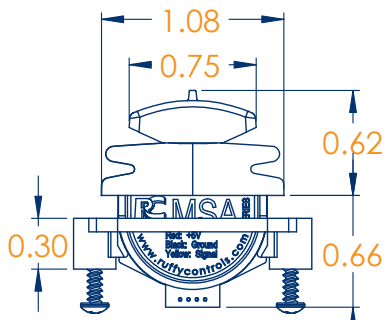
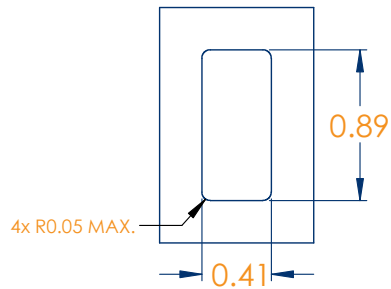

04292024mp

