

CIRCUIT PROTECTION

COOPER

Bussmann®

Circuit Protection Group



The Cooper Bussmann® Electronic Fuse family offers fail-safe circuit protection devices in SMD, Thru-Hole, and traditional Ferrule Fuse packages.



CHIP™ Fuses (0603FA & 3216FF Series)



Cooper Bussmann's patented Solid Matrix CHIP™ fuses provide reliable overcurrent protection to secondary circuits found in mobile phone handsets, battery packs, digital still cameras, PDA's, HDD's, printers, notebook computers, televisions, automotive instrument panels, battery packs, and more. Its excellent cycling characteristics, small footprint, and SMD package provide the most effective, reliable overcurrent protection solution for today's - and tomorrow's - technologies.

Telecom Circuit Protector (TCP Series)

Cooper Bussmann is proud to be the first to offer a surface mount telecom circuit protector designed to protect against power cross faults and comply with surge requirements for the telecom industry. Today, you will find the TCP Series fuse in central office subscriber line interface cards, basestations, set-top box modems, and xDSL modems among other applications.



BRICK™ Fuses (6125FA/TD & 1025FA/TD Series)

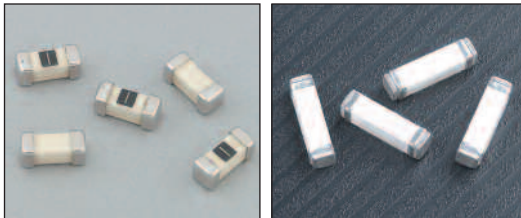

Cooper Bussmann's patented BRICK™ fuses provide the excellent inrush withstand capabilities in a space saving SMD package needed in many of today's more demanding applications such as power supplies, base stations, televisions, computers, white goods, and motor control circuits among others.

SR-5 & SS-5 Series Radial Leaded Fuses

Cooper Bussmann is bringing the space-saving SR-5 and SS-5 family of radial leaded fuses to the global market to provide cost-effective primary circuit protection in space-constrained applications such as power adapters, televisions, handheld consumer products, white goods, and more.



IEC & UL Electronic Fuses

In addition to SMD and Thru-Hole Device Fuses, Cooper Bussmann offers a full range of traditional electronic fuses designed to IEC standards (5mm product line) and UL standards (1/4" product line). Both product lines offer a cost-efficient overcurrent protection solution for a wide range of applications including power supplies, white goods, motor control equipment, and set-top boxes. Coupled with one of Cooper Bussmann's extensive fuse accessories product offerings, these fuses can be conveniently

inserted into a circuit while allowing for end-user replacement if desired. And with Cooper Bussmann's expansive global distribution, your customers will have easy access to ensure safe, reliable, correct replacement parts available when needed.

Electrical Fuses

Cooper Bussmann® brand power fuses are the industry leader for your more demanding power applications.

From the innovative CUBEFuse™ product line – offering touch-safe, current-limiting fusible protection – to the time-honored Fusetron® product line with class-leading time-delay performance, Cooper Bussmann® fuses set the standard for motor and branch circuit protection. And now, with easyID™ technology available with the CUBEFuse™ and Low-Peak® product lines, reliable permanent open fuse indication for reduced downtime and maintenance costs.

For more delicate semiconductor drive applications, Cooper Bussmann High Speed fuses provide rapid response to damaging short circuits keeping your investment safe from damages. And look no further than the Cooper Bussmann Telpower® brand fuses for protection of critical telecommunication infrastructure.



PolySurg™ ESD Suppression Devices

Cooper Bussmann PolySurg™ ESD Suppressors are bi-directional ESD overvoltage protection devices that respond in less than 1ns and can protect against a threat voltage up to 15kV per IEC standard 61000-4-2. With leakage current of less than 1nA and an ultra low capacitance less than 0.15pF, these devices are an especially viable solution for high data rate applications. With an insertion loss of less than -0.2dB at frequencies up to 6 GHz, the PolySurg™ ESD Suppressors are invisible to the protected circuit, introducing no additional loading or signal distortion.



ESD Protection for High Frequency, Low Voltage Designs

PolySurg™ surface mount devices are ideally suited for ESD protection of data I/O ports, computers and peripherals, media interfaces (DVI and HDMI), mobile communication products, hand-held test equipment and other similar uses.

MLP Series Now Available

The MLP Series, comprised of the 0402ESDA-MLP and 0603ESDA-MLP ESD suppression devices, is now available as discrete devices in an 0402 and 0603 footprint, respectively. This series utilizes Cooper Bussmann's patented PolyFAMILY design to deliver enhanced ESD protection using state of the art process and material technologies.

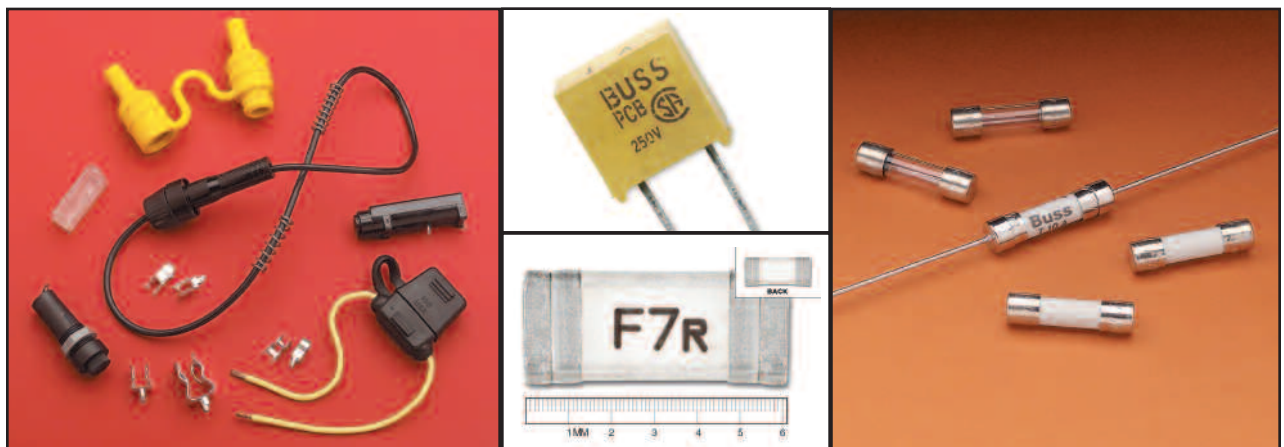

TABLE OF CONTENTS

Fuse Technology	OC-3
Printed Circuit Board Fuses	
Surface Mount Fuses	
0603FA Chip™ Fuses	OC-12
3216TD Chip™ Fuses	OC-14
3216FF Chip™ Fuses	OC-16
3216LV Chip™ Fuses	OC-18
6125TD Brick™ Fuses	OC-20
6125FF Brick™ Fuses	OC-22
6125FA Brick™ Fuses	OC-24
1025TD Brick™ Fuses	OC-26
1025FA Brick™ Fuses	OC-28
TCP™ Series Telecom Circuit Protector	OC-30
Axial and Radial Leaded Fuses	
MCRW Series Subminiature Microtron® Fuses	OC-34
MCRS Series Subminiature Microtron® Fuses	OC-36
PC-Tron® Series PCB Fuses	OC-38
SR-5 Series Subminiature Fuses	OC-40
SS-5 Series Subminiature Fuses	OC-42
SR-5F Series Subminiature Fuses	OC-44
SS-5F Series Subminiature Fuses	OC-46
SR-5H Series Subminiature Fuses	OC-48
Traditional Ferrule Fuses	
Ferrule Type Fuses	
C515 Series 5mm x 15mm Fuses	OC-50
C517 Series 5mm x 15mm Fuses	OC-52
C518 Series 5mm x 15mm Fuses	OC-54
C519 Series 5mm x 15mm Fuses	OC-56
C520 Series 5mm x 15mm Fuses	OC-58
S500 Series 5mm x 20mm Fuses	OC-60
S501 Series 5mm x 20mm Fuses	OC-62
S505 Series 5mm x 20mm Fuses	OC-64
S506 Series 5mm x 20mm Fuses	OC-66
GMA Series 5mm x 20mm Fuses	OC-68
GMC Series 5mm x 20mm Fuses	OC-70
GMD Series 5mm x 20mm Fuses	OC-72
AGA Series 1/4" x 5/8" Fuses	OC-74
AGX Series 1/4" x 1" Fuses	OC-76
TDC Series 1/4" x 1-1/4" Fuses	OC-78
ABC Series 1/4" x 1-1/4" Fuses	OC-80
AGC Series 1/4" x 1-1/4" Fuses	OC-82
GBB Series 1/4" x 1-1/4" Fuses	OC-84

Ferrule Type Fuses (Cont.)

MDA Series 1/4" x 1-1/4" Fuses	OC-86
MDL Series 1/4" x 1-1/4" Fuses	OC-88
MDQ Series 1/4" x 1-1/4" Fuses	OC-90

Automotive Fuses

Blade Fuses

ATM Series Blade-Type Fuses	OC-92
ATC Series Blade-Type Automotive Fuses	OC-93
MAX Series Blade-Type Fuses	OC-94

Accessories

Fuseclips

5mm Diameter Fuseclips	OC-95
1/4" Diameter Fuseclips	OC-96

Fuseholders

HTC PCB Series 5mm x 20mm Fuseholders	OC-97
HTC PM Series 5mm x 20mm Fuseholders	OC-98
HB PCB Series 1/4" x 1-1/4" Fuseholders	OC-99
HKP PM Series 1/4" x 1-1/4" Fuseholders	OC-100
HTB PM Series Fuseholders	OC-102
HHB In-Line Series 1/4" x 7/8" to 1-1/4" Fuseholders	OC-104
HFB In-Line Waterproof Series 1/4" x 1-1/4" Fuseholders	OC-105
HFA In-Line Waterproof Series 1/4" x 1-1/4" Fuseholders	OC-106
HRK Universal In-Line Series 1/4" x 7/8" to 1-1/4" Fuseholders	OC-107
MINI® Fuseholders (HHL & HHM)	OC-108
ATC® Fuseholders (HHC, HHD, HHF, HHG)	OC-109
MAXI® Fuseholders (HHX)	OC-110

Fuseblocks

HTC Series 5mm x 20mm Fuseblocks	OC-111
S-8000 Series 1/4" x 1-1/4" Fuseblocks	OC-112

Overvoltage Protection

PolySurg™ ESD Suppressors

ESD Suppression Selection Guide	OC-114
0402ESDA-MLP, MLP Series ESD Suppressor	OC-118
0603ESDA-MLP, MLP Series ESD Suppressor	OC-120
0603ESDA-TR, TR Series ESD Suppressor	OC-122

Application Notes, ESD Suppression

ESD Protection of Set Top Appliances with PolySurg™ ESD Suppressors	OC-125
ESD Protection of High-Speed Data Lines	OC-127
ESD Protection for High Speed Digital Video Solutions (DVI & HDMI)	OC-129

FUSE TECHNOLOGY

This fuse technology guide will discuss basic fuse operating, application, and selection criteria concepts. The intended purpose of this section is to aid designers with the operation and characteristics of an overcurrent protection device and to assist in device selection.

Overcurrent fuses serve two main purposes:

- a. To protect components, equipment and people from risk of fire and shock caused by overcurrents.
- b. To isolate sub systems from the main system once a fault has occurred.

Overcurrents

Overcurrents exist when the normal load for a circuit is exceeded. It can either be an overload or short circuit condition.

An overload condition is any current flowing within the circuit path that is higher than the circuit's normal full load current. An overload is typically 2 to 5 times the magnitude of a circuit's normal operating current.

A short circuit is an overcurrent condition that leaves the normal current path and which greatly exceeds the normal full load current of the circuit by a factor of tens, hundreds, or thousands. Components and equipment can be damaged by both types of overcurrents.

Selecting Overcurrent Protection

During normal load conditions, the fuse must carry the normal operating current of the circuit without nuisance openings. However, when an overcurrent occurs the fuse must interrupt the overcurrent and withstand the voltage across the fuse after internal arcing. To properly select a fuse the following items must be considered:

- Voltage rating (ac or dc voltage)
- Current rating
- Normal operating current

- Ambient temperature
- Overload conditions and opening times
- Available short circuit current
- Melting Integral (I^2t)
- Pulse and In-rush characteristics
- Characteristics of equipment or components to be protected
- Physical size and available board space
- Standards requirements

Voltage Ratings

The voltage rating of the fuse must be greater than or equal to the maximum open circuit voltage. Because the fuse has such low resistance, the voltage rating becomes critical only when the fuse is trying to open. The fuse must be able to open quickly, extinguish the arc after the fuse element has melted and prevent the system's open-circuit voltage from re-striking across the open fuse element.

Current Ratings

The current rating of a fuse identifies its current-carrying capacity based on a controlled set of test conditions. Each fuse is marked with its current rating. This rating can be identified with a numeric, alpha, or color code mark. Marking codes can be found in each product's data sheet.

Normal Operating Current

The normal operating current of a circuit is the level of current drawn (in RMS or dc amperes) after it has been energized and is operating under normal conditions. An operating current of 80% or less of rated current is recommended for operation at 25°C to avoid nuisance openings. For example, a fuse with a current rating of 1A is usually not recommended in circuits with normal operating currents of more than 800mA. Further derating is required at elevated ambient temperatures.

Ambient Temperature

Ambient temperature is the temperature of the air immediately surrounding the fuse and is not necessarily room temperature. All electrical characteristics of a fuse are rated and validated at an ambient temperature of 25°C. Both higher and lower ambient temperatures will affect the fuse's opening and current carrying characteristics. This effect is demonstrated in temperature re-rating curves. Please refer to the re-rating curves for individual product series found in the Engineering Product Specifications located on the Cooper Electronic Technologies web site, or contact CET directly for technical assistance.

Overload Conditions and Opening Times

Specific attention must be given to first overload operating points. For fuses, the first overload point is usually between 200% to 300% of rated current. 400% is typically the first overload point for circuit protectors.

Breaking Capacity / Interrupting Rating

A fuse must be able to open the circuit under a short circuit condition without endangering its surroundings. The breaking capacity or interrupting rating of a protective device is the maximum available current, at rated voltage, that the device can safely open without rupturing. The breaking capacity or interrupting rating of a fuse must be equal to or greater than the available short circuit current of the circuit.

Melting Integral

The melting integral of a fuse, termed melting I^2t , is the thermal energy required to melt a specific fuse element. The construction, materials, and cross sectional area of the fuse element will determine this value. Each fuse series and ampere rating utilize different materials and element configurations, and therefore it is necessary to determine the I^2t value for each fuse. Tests to determine the I^2t of a fuse are

usually performed with a fault current of at least 10x the rated current with a time constant of less than 50 microseconds in a DC test circuit. High-speed oscilloscopes and integral programs are used to measure very accurate I^2t values.

The melting I^2t of a fuse is one of the values used to assist circuit designers when selecting and properly sizing a fuse in a specific application. It can be compared to the thermal energy created by transient surge currents in a circuit.

Surge and Pulse Current Characteristics

Transient surge or pulse currents are used to describe wave shapes that result from any startup, inrush, surge, or transient currents in a circuit. The pulse currents are normal for some applications. It is therefore important to size the fuse properly to allow these pulses to pass without nuisance openings or degradation of the fuse element. The fuse must then open within the limits specified by UL and CSA if the overload condition continues. The ability to resist surges is a function of the fuse design and/or classification relative to the surge pulse, duration frequency etc.

Pulse currents can produce thermal energy that may not be large enough to open the fuse but could possibly cause element fatigue and decrease the life of the fuse. To properly size a fuse and determine its surge withstand capability, the circuit's pulse energy should be determined and compared to the time current curve and I^2t rating of the fuse. The fuse's melting I^2t value must be greater than or equal to the pulse I^2t multiplied by a pulse factor.

The peak current and decay time define the pulse current characteristic or waveform. Pulses can generate different waveform shapes, which determines the formula used to calculate the pulse energy or I^2t . Refer to Table 1 to select the appropriate waveform and its corresponding pulse I^2t calculation.

Table 1. Pulse Waveshapes and I²t Calculations

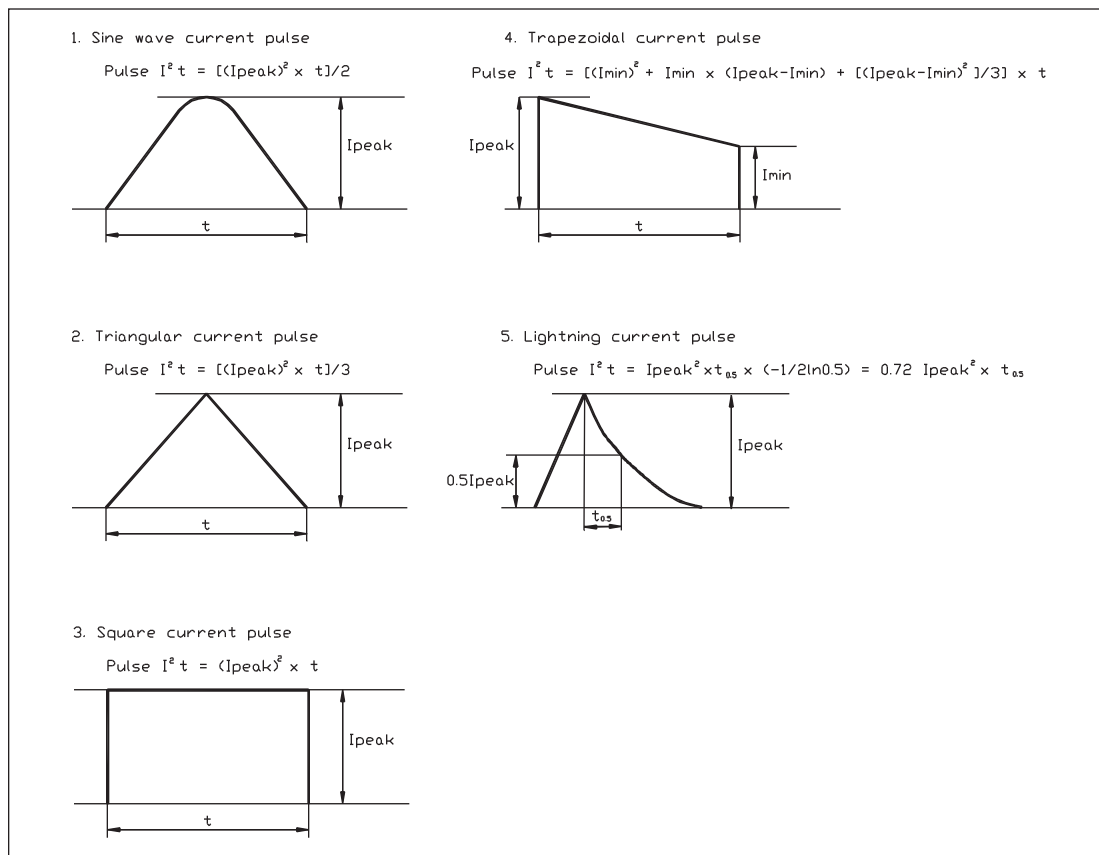

Fuse Surge Withstand Capability

The fuse's capability to withstand a surge pulse without causing thermal stress to the fuse element, which may result in nuisance openings, can be determined once the circuit's pulse I²t is calculated. The circuit designer needs to properly size the fuse so that the fuse's melting I²t value is greater than or equal to the pulse I²t multiplied by a pulse factor F_p ($I^2t_{fuse} \geq I^2t_{pulse} \times F_p$).

The pulse factor is dependent on the construction of the fuse element. A wire-in-air constructed fuse element (ferrule fuses, 6125 and 1025 series for example) will be affected by the number and frequency of surge pulses the fuse is subjected to over the lifetime of the device. This construction design utilizes low-melting-point metals plated or deposited on the main element material to cause an "M" effect. If the fuse is sized improperly, low level pulse currents may cause the low-melting-point metals to alloy to the element without completely opening the element.

A series of pulse currents will eventually create enough heat to shift resistance or even permanently open the fuse. Thus it is important to take into account the number of pulse currents to which the fuse will be subjected.

Solid matrix fuses (for example 0603FA or 3216FF sized surface mount fuses) do not currently use an "M" effect for the element construction. The element will only then be affected by the thermal energy of each pulse, and will not normally degrade as a result of the number or frequency of pulses. Please refer to Table 2 to determine the pulse factor, F_p.

For example, a pulse current with an I²t of 0.0823 and a pulse factor, F_p=1.25 would require the selection of a fuse to have a melting I²t greater than or equal to 0.1029.

$$\begin{aligned} \text{Melting } I^2t_{fuse} &\geq I^2t_{pulse} \times F_p \\ \text{Melting } I^2t_{fuse} &\geq 0.0823 \times 1.25 \\ \text{Melting } I^2t_{fuse} &\geq 0.1029 \end{aligned}$$

It is important to note that the melting I^2t values of the fuse and pulse current that are compared must be calculated or tested at the same test conditions, most importantly the magnitude of the peak current must be the same. For example, if the pulse's peak current is 15A, then the fuse's melting I^2t must be calculated at 15A as well to fully understand its electrical characteristics at that magnitude of current. Please contact CET directly for technical assistance.

Table 2. Pulse Factor, F_p

Solid Matrix Construction

Number of Surge Pulses	Pulse Factor, F_p
1 to 100,000	1.25

Wire-in-Air Construction

Number of Surge Pulses	Pulse Factor, F_p
100	2.1
1,000	2.6
10,000	3.4
100,000	4.5

Time vs. Current Curves

A time current curve represents the relationship between a fuse's melting or clearing time and the magnitude of RMS or dc current. The characteristics represented on most published graphs usually indicate a fuse's average melting time when subjected to a certain level of current. The curves will typically demonstrate the ability to carry 100% of rated current, and then also represent the fuse's ability to open within the maximum opening time at designated overload points (typically 135% to 300% of the fuse rating). Time vs. current curves are a useful design aid for an engineer when specifying a fuse type or rating for an application. It is however recommended that fuse samples be tested in the actual application to verify performance.

Fuse Resistance

In most applications, the voltage drop across the fuse due to its internal and contact resistance is negligible. There are, however, certain critical applications where the fuse resistance must be considered and it is important that the circuit designer understands the fuse characteristics in order to select the proper fuse. Applications that are powered by low voltage batteries, typically 3V or less, and utilize fractional rated fuses with high resistance may require special attention be given to the voltage drop across the fuse.

Physical Sizes

There are numerous physical sizes of electronic fuses, including subminiature fuses. The most common ferrule designs are 5x15mm, 5x20mm and 6.3x32mm (1/4" x 1 1/4").

Subminiature fuses are often used when board space is limited. For applications of this type, there are through-hole and surface mount devices available. Standard package sizes for surface mount fuses are 0402 (1005), 0603 (1608), 1206 (3216), 6125, and 1025. These sizes are standard throughout the electronic industry. Through-hole axial and radial leaded products allow fuses to be PCB mounted. Standard ferrule fuses fitted with leads can also be mounted in this way.

Physical Sizes of Traditional Ferrule Fuses

5mmx20mm	0.2" x .79"
1AG	1/4" x 5/8"
2AG (5mmx15mm)	0.2" x .59"
3AG	1/4" x 1 1/4"
4AG	9/32" x 1 1/4"
5AG	13/32" x 1 1/2"
7AG	1/4" x 7/8"
8AG	1/4" x 1"

Standards

North American UL/CSA and IEC standards require significantly different time vs. current characteristics for overcurrent devices.

Typically the physical dimensions and materials used are similar; however, fuses built to different standards are not interchangeable because their element melting and opening times will differ when subjected to the same magnitude of current. It is therefore important for the circuit designer to consider that world standards may require different fuses.

Glossary of Terms

Ampere squared seconds I^2t

The melting, arcing, or clearing integral of a fuse, termed I^2t , is the thermal energy required to melt, arc, or clear a specific current. It can be expressed as melting I^2t , arcing I^2t or the sum of them, clearing I^2t .

Arcing time

The amount of time from the instant the fuse link has melted until the overcurrent is interrupted, or cleared.

Clearing time

The total time between the beginning of the overcurrent and the final opening of the circuit at rated voltage by an overcurrent protective device. Clearing time is the total of the melting time and the arcing time.

Fast acting fuse

A fuse which opens on overload and short circuits very quickly. This type of fuse is not designed to withstand temporary overload currents associated with some electrical loads. UL listed or recognized fast acting fuses would typically open within 5 seconds maximum when subjected to 200% to 250% of its rated current. IEC has two categories of fast acting fuses:

- F = quick acting, opens 10x rated current within 0.001 seconds to 0.01 seconds
- FF = very quick acting, opens 10x rated current in less than 0.001 seconds

Fuse

An overcurrent protective device with a fusible link that operates and permanently opens the circuit on an overcurrent condition.

Overcurrent

A condition which exists in an electrical circuit when the normal load current is exceeded. Overcurrents take on two separate characteristics-overloads and short circuits.

Overload

Can be classified as an overcurrent which exceeds the normal full load current of a circuit by 2 to 5 times its magnitude and stays within the normal current path.

Resistive load

An electrical load which is characterized by not drawing any significant inrush current. When a resistive load is energized, the current rises instantly to its steady state value, without first rising to a higher value.

RMS Current

The R.M.S. (root mean square) value of any periodic current is equal to the value of the direct current which, flowing through a resistance, produces the same heating effect in the resistance as the periodic current does.

Short circuit

An overcurrent that leaves the normal current path and greatly exceeds the normal full load current of the circuit by a factor of tens, hundreds, or thousands times.

Time delay fuse

A fuse with a built-in time delay that allows temporary and harmless inrush currents to pass without operating, but is so designed to open on sustained overloads and short circuits. UL listed or recognized time delay fuses typically open in 2 minutes maximum when subjected to 200% to 250% of rated current. IEC has two categories of time delay fuses:

- T = time lag, opens 10x rated current within 0.01 seconds to 0.1 seconds
- TT = long time lag, opens 10x rated current within 0.1 seconds to 1 second

Voltage rating

A maximum open circuit voltage in which a fuse can be used, yet safely interrupt an overcurrent. Exceeding the voltage rating of a fuse impairs its ability to clear an overload or short circuit safely.

Selection Guide

The following is a quick selection guide to assist in selecting the appropriate product series for your application. Please refer to the corresponding catalog pages for a complete listing of product specifications.

Chip Fuses						
Product Series	Voltage Rating	Amp Rating	Electrical Characteristic	Size	Mounting Method	3rd Party Testing
0603FA	32 VDC 24 VDC	250mA - 2A 2.5A-5A	Fast Acting	1.6mmx0.8mm (.060"x.030")	Surface Mount	UL/CSA
3216FF	32 VAC, 63 VDC 32 VAC, 32 VDC	250mA-3A 4A-7A	Fast Acting	3.2mmx1.6mm (.120"x.060")	Surface Mount	UL/CSA
3216TD	63 VAC, 63 VDC 32 VAC, 32 VDC	1A 1.5A-12A	Time Delay	3.2mmx1.6mm (.120"x.060")	Surface Mount	cRUus
3216LV	125 VAC/DC	250mA-1.5A	Fast Acting	3.2mmx1.6mm (.120"x.060")	Surface Mount	UL/CSA

Brick Fuses						
Product Series	Voltage Rating	Amp Rating	Electrical Characteristic	Size	Mounting Method	3rd Party Testing
6125TD	125VAC, 60VDC	250mA-7A	Time Delay	6.1mmx2.5mm (0.24"x0.1")	Surface Mount	UL/CSA
6125FF	125VAC, 72VDC	375mA-15A	Fast Acting	6.1mmx2.5mm (0.24"x0.1")	Surface Mount	cRUus
6125FA	125VAC, 125VDC 125VAC, 86VDC 86VDC	250mA-7A 10A-12A 15A	Fast Acting	6.1mmx2.5mm (0.24"x0.1")	Surface Mount	UL/CSA
1025TD	250AC, 125VDC	250mA-5A	Time Delay	10.1mmx2.5mm (0.4"x0.1")	Surface Mount	UL/CSA
1025FA	250VAC, 125VDC	250mA-15A	Fast Acting	10.1mmx2.5mm (0.4"x0.1")	Surface Mount	UL/CSA

Telecom Fuses						
Product Series	Voltage Rating	Amp Rating	Electrical Characteristic	Size	Mounting Method	3rd Party Testing
TCP	250VAC	500mA-2A	Time Delay for Telecom Applications	10.1mmx2.5mm (0.4"x0.1")	Surface Mount	UL/CSA

Traditional Subminiature Fuses						
Product Series	Voltage Rating	Amp Rating	Electrical Characteristic	Size	Mounting Method	3rd Party Testing
MCRW	125VAC, 125VDC	1/10A-15A	Fast Acting, Wire in Air	7.1mmx3.18mm (.280"x.125")	Axial Through Hole	UL/CSA
MCRS	125VAC, 125VDC	250MA-7A	Slow Blow, Wire in Air	7.1mmx3.18mm (.280"x.125")	Axial Through Hole	UL/CSA
PC-Tron	250VAC, 450VDC 250VAC, 350VDC 125VAC, 250VDC	500mA-2.5A 3A 5A	Fast Acting, Solid Matrix	8.89mmx8.89mm (.35"x.35")	Radial Through Hole	UL/CSA
SR-5	250VAC	500mA-6.3A	Time Delay	8.35mmx7.7mm (.33"x.3")	Radial Through Hole	UL/CSA SEMKO/VDE
SS-5	250VAC	500mA-6.3A	Time Delay	8.6mmx8.4mm (.34"x.33")	Radial Through Hole	UL/CSA SEMKO/VDE
SR-5F	250VAC 125VAC	800mA-5A 6.3A-10A	Fast Acting	8.35mmx7.7mm (.33"x.3")	Radial Through Hole	UL/CSA
SS-5F	250VAC 125VAC	800mA-5A 6.3A-10A	Fast Acting	8.6mmx8.4mm (.34"x.33")	Radial Through Hole	UL/CSA
SR-5H	300VAC 250VAC	1A-6.3A	Time Delay	8.35mmx8.6mm (.33"x.34")	Radial Through Hole	cURus SEMKO/VDE

1/4" Diameter Ferrule Fuses						
Product Series	Voltage Rating	Amp Rating	Electrical Characteristic	Size	Mounting Method	3rd Party Testing
AGA	125VAC, 32VAC	63mA-30A	Fast Acting	6.3mmx15.9mm (1/4"x5/8")	Clips, Blocks, and Holders	UL/UR
AGA-V	125VAC, 32VAC	63mA-30A	Fast Acting	6.3mmx15.9mm (1/4"x5/8")	Axial Through Hole	UL/UR
AGX	250VAC, 125VAC, 32VAC	1/500mA-30A	Fast Acting	6.3mmx25.4mm (1/4"x1")	Clips, Blocks, and Holders	UL/UR/CSA
AGX-V	250VAC, 125VAC, 32VAC	1/500mA-30A	Fast Acting	6.3mmx25.4mm (1/4"x1")	Axial Through Hole	UL/UR/CSA
ABC	250VAC, 125VAC	1/4A-30A	Fast Acting	6.3mmx32mm (1/4"x1-1/4")	Clips, Blocks, and Holders	UL/UR/CSA
ABC-V	250VAC, 125VAC	1/4A-30A	Fast Acting	6.3mmx32mm (1/4"x1-1/4")	Axial Through Hole	UL/UR/CSA
AGC	250VAC, 32VAC	1/20A-30A	Fast Acting	6.3mmx32mm (1/4"x1-1/4")	Clips, Blocks, and Holders	UL/UR/CSA
AGC-V	250VAC, 32VAC	1/20A-30A	Fast Acting	6.3mmx32mm (1/4"x1-1/4")	Axial Through Hole	UL/UR/CSA
GBB	250VAC	1A-30A	Very Fast Acting	6.3mmx32mm (1/4"x1-1/4")	Clips, Blocks, and Holders	UR/CSA
GBB-V	250VAC	1A-30A	Very Fast Acting	6.3mmx32mm (1/4"x1-1/4")	Axial Through Hole	UR/CSA
MDA	250VAC	2/10A-30A	Time Delay	6.3mmx32mm (1/4"x1-1/4")	Clips, Blocks, and Holders	UL/CSA
MDA-V	250VAC	2/10A-30A	Time Delay	6.3mmx32mm (1/4"x1-1/4")	Axial Through Hole	UL/CSA
MDL	250VAC, 32VAC	1/16A-30A	Time Delay	6.3mmx32mm (1/4"x1-1/4")	Clips, Blocks, and Holders	UL/UR/CSA
MDL-V	250VAC, 32VAC	1/16A-30A	Time Delay	6.3mmx32mm (1/4"x1-1/4")	Axial Through Hole	UL/UR/CSA
MDQ	250VAC	1/100A-15A	Dual Element Time Delay	6.3mmx32mm (1/4"x1-1/4")	Clips, Blocks, and Holders	UL/UR/CSA
MDQ-V	250VAC	1/100A-15A	Dual Element Time Delay	6.3mmx32mm (1/4"x1-1/4")	Axial Through Hole	UL/UR/CSA

5x15mm Ferrule Fuses						
Product Series	Voltage Rating	Amp Rating	Electrical Characteristic	Size	Mounting Method	3rd Party Testing
C515	250VAC	125mA-7A	Time Delay	5.5mmx15.2mm (0.22"x0.60")	Axial Through Hole	UL/UR/CSA
C517	350VAC	3A	Fast Acting	5.5mmx15.2mm (0.22"x0.60")	Axial Through Hole	UL/UR/CSA
C518	250VAC	100mA-5A	Fast Acting	5.5mmx15.2mm (0.22"x0.60")	Axial Through Hole	UL/CSA
C519	250VAC	125mA-5A	Time Delay	5.2mmx15mm (0.20"x0.59")	Clips, Blocks, and Holders	UL/UR/CSA
C520	250VAC	100mA-5A	Fast Acting	5.2mmx15mm (0.20"x0.59")	Clips, Blocks, and Holders	UL/CSA

5x20mm Ferrule Fuses						
Product Series	Voltage Rating	Amp Rating	Electrical Characteristic	Size	Mounting Method	3rd Party Testing
GMA	250VAC, 125VAC	63mA-15A	Fast Acting	5.2mmx20mm (0.20"x0.79")	Clips, Blocks, and Holders	UL/UR/CSA/MITI
GMA-V	250VAC, 125VAC	63mA-15A	Fast Acting	5.5mmx21.1mm (0.22"x0.83")	Axial Through Hole	UL/UR/CSA/MITI
GMC	250VAC, 125VAC	50mA-10A	Medium Time Delay	5.2mmx20mm (0.20"x0.79")	Clips, Blocks, and Holders	UL/UR/CSA/MITI
GMC-V	250VAC, 125VAC	50mA-10A	Medium Time Delay	5.5mmx21.1mm (0.22"x0.83")	Axial Through Hole	UL/UR/CSA/MITI
GMD	250VAC	125mA-4A	Time Delay	5.2mmx20mm (0.20"x0.79")	Clips, Blocks, and Holders	UL/UR/CSA/MITI
GMD-V	250VAC	125mA-4A	Time Delay	5.5mmx21.1mm (0.22"x0.83")	Axial Through Hole	UL/UR/CSA/MITI
S500	250VAC	32mA-10A	Fast Acting, Low Breaking Capacity	5.2mmx20mm (0.20"x0.79")	Clips, Blocks, and Holders	UR/CSA/Semko/ VDE/IMQ/BSI
S500-V	250VAC	32mA-10A	Fast Acting, Low Breaking Capacity	5.5mmx21.1mm (0.22"x0.83")	Axial Through Hole	UR/CSA/Semko/ VDE/IMQ/BSI
S501	250VAC	50mA-10A	Fast Acting, High Breaking Capacity	5.2mmx20mm (0.20"x0.79")	Clips, Blocks, and Holders	UR/Semko/ VDE/IMQ
S501-V	250VAC	50mA-10A	Fast Acting, High Breaking Capacity	5.5mmx21.1mm (0.22"x0.83")	Axial Through Hole	UR/Semko/ VDE/IMQ
S505	250VAC	500mA-12A	Time Delay, High Breaking Capacity	5.5mmx21.1mm (0.22"x0.83")	Clips, Blocks, and Holders	UR/BSI/MITI/ Semko/VDE/IMQ
S505-V	250VAC	500mA-12A	Time Delay, High Breaking Capacity	5.5mmx21.1mm (0.22"x0.83")	Axial Through Hole	UR/BSI/MITI/ Semko/VDE/IMQ
S506	250VAC	32mA-15A	Time Delay, Low Breaking Capacity	5.2mmx20mm (0.20"x0.79")	Clips, Blocks, and Holders	UR/BSI/MITI/ Semko/VDE/IMQ
S506-V	250VAC	32mA-15A	Time Delay, Low Breaking Capacity	5.5mmx21.1mm (0.22"x0.83")	Axial Through Hole	UR/BSI/MITI/ Semko/VDE/IMQ

Fuse Accessory Selection Guide

Fuse	Size	PC Board Fuse Clip (Qty. 2)	PC Board Mount Holder	Panel Mount Holder	In-Line Fuse Holder	Fuseblock
ABC	1/4" x 1-1/4"	1A1907	HBH-I / HBV-I	HTB / HKP	HRK / HHB / HFA	S-8000
AGA	1/4" x 5/8"	1A1907	-	-	-	-
AGC	1/4" x 1-1/4"	1A1907	HBH-I / HBV-I	HTB / HKP	HRK / HHB / HFA	S-8000
AGU	13/32" x 1-1/2"	1A3400	-	HPG	HEB	BM6031PQ
AGW	1/4" x 7/8"	1A1907	-	-	HRK / HHB / HFA	-
AGX	1/4" x 1"	1A1907	-	HJL	HRK / HHB / HFA	3828-1
ATC	-	1A5600	-	-	HHD	-
ATM	-	1A5778	-	-	HHM	-
BAF	13/32" x 1-1/2"	1A3400	-	HPG	HEB	BM6031PQ
BAN	13/32" x 1-1/2"	1A3400	-	HPG	HEB	BM6031PQ
BBS	13/32" x 1-3/8"	1A3400	-	HPS-L	HEH	BM6031PQ
C519	5mm x 15mm	1A3399	-	-	HHT	-
C520	5mm x 15mm	1A3399	-	-	HHT	-
DCM	13/32" x 1-1/2"	1A3400	-	HPG	HEB	BM6031PQ
FNA	13/32" x 1-1/2"	1A3400	-	HPG	HEB	BM6031PQ
FNM	13/32" x 1-1/2"	1A3400	-	HPG	HEB	BM6031PQ
FNQ	13/32" x 1-1/2"	1A3400	-	HPG	HEB	BM6031PQ
FNQ-R	13/32" x 1-1/2"	1A3400	-	HPG	HEB	BC6031PQ
FWH	1/4" x 1-1/4"	1A1907	-	-	-	-
GBA	1/4" x 1-1/4"	1A1907	-	HLD	HRK / HHB / HFA	S-8000
GBB	1/4" x 1-1/4"	1A1907	HBH-I / HBV-I	HTB / HKP	HRK / HHB / HFA	S-8000
GLD	1/4" x 1-1/4"	1A1907	-	HLD	HRK / HHB / HFA	S-8000
GMA	5mm x 20mm	1A3399	HTC-45M / -50M	HTB / HTC	HHT	HTC-15M
GMC	5mm x 20mm	1A3399	HTC-45M / -50M	HTB / HTC	HHT	HTC-15M
GMD	5mm x 20mm	1A3399	HTC-45M / -50M	HTB / HTC	HHT	HTC-15M
KLM	13/32" x 1-1/2"	1A3400	-	HPG	HEB	BM6031PQ
KTK	13/32" x 1-1/2"	1A3400	-	HPG	HEB	BM6031PQ
KTK-R	13/32" x 1-1/2"	1A3400	-	HPG	HEB	BC6031PQ
KTQ	13/32" x 1-3/8"	1A3400	-	HPS-L	HEH	BM6031PQ
LP-CC	13/32" x 1-1/2"	1A3400	-	HPG	HEB	BC6031PQ
MDA	1/4" x 1-1/4"	1A1907	HBH-I / HBV-I	HTB / HKP	HRK / HHB / HFA	S-8000
MDL	1/4" x 1-1/4"	1A1907	HBH-I / HBV-I	HTB / HKP	HRK / HHB / HFA	S-8000
MDQ	1/4" x 1-1/4"	1A1907	HBH-I / HBV-I	HTB / HKP	HRK / HHB / HFA	S-8000
MIC	13/32" x 1-1/2"	1A3400	-	HPG	HEB	BM6031PQ
MIN	13/32" x 1-1/2"	1A3400	-	HPG	HEB	BM6031PQ
PCB	-	-	PCS	-	-	-
PCD	-	-	PCS	-	-	-
S500 / GDB	5mm x 20mm	1A3399	HTC-45M / -50M	HTB / HTC	HHT	HTC-15M
S501 / GDA	5mm x 20mm	1A3399	HTC-45M / -50M	HTB / HTC	HHT	HTC-15M
S505	5mm x 20mm	1A3399	HTC-45M / -50M	HTB / HTC	HHT	HTC-15M
S506 / GDC	5mm x 20mm	1A3399	HTC-45M / -50M	HTB / HTC	HHT	HTC-15M
SC-1 to 15	13/32" x 1.31"	1A3400	-	HPS-EE	HEG	BG3011PQ
SC-20	13/32" x 1.41"	1A3400	-	HPS-JJ	HEH	BG3021PQ
SC-25 to 30	13/32" x 1.63"	1A3400	-	HPS-FF	HEC	BG3031PQ
SC-35 to 60	13/32" x 2-1/4"	1A3400	-	-	HEJ	G30060-1CR
SR-5	-	-	PCS	-	-	-
SR-5F	-	-	PCS	-	-	-
SS-5	-	-	PCS	-	-	-
SS-5F	-	-	PCS	-	-	-
TDC10	1/4" x 1-1/4"	1A1907	HTC-45M / -50M	HTB / HKP	HRK / HHB / HFA	S-8000
TDC11	1/4" x 1-1/4"	1A1907	HTC-45M / -50M	HTB / HKP	HRK / HHB / HFA	S-8000
TDC180	1/4" x 1"	1A1907	-	HJL	HRK / HHB / HFA	3828-1

Description

- Rapid interruption of excessive current
- Compatible with reflow and wave solder
- Rugged ceramic and glass construction
- Excellent environmental integrity
- One time positive disconnect
- Compatible with lead free solders and higher temperature profiles

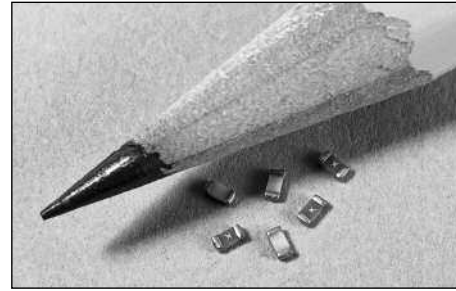

ELECTRICAL CHARACTERISTICS	
% of Amp Rating	Opening Time
100%	4 Hours Minimum
200%	60 Seconds Maximum

Agency Information

- UL Recognition Guide & File numbers: JDYX2 & E19180
- CSA Component Acceptance: 053787 C 000 & Class Number: 1422 30

Environmental Data

- Life Test: MIL-STD-202, Method 108A
- Load Humidity Test: MIL-STD-202, Method 103B
- Moisture Resistance Test: MIL-STD-202, Method 106E
- Terminal Strength Test: Downward force is applied to cause a 1mm deflection for 1 minute
- Thermal Shock Test: MIL-STD-202, Method 107D
- Solderability: ANSI/J-STD-002
- Mechanical Shock Test: MIL-STD-202, Method 213B
- High Frequency Vibration Test: MIL-STD-202, Method 204D
- Resistance to Solvents Test: MIL-STD-202, Method 215A

Ordering

- Specify packaging and product code (i.e., TR/0603FA250-R)

Dimensions mm/(inches)
Drawing Not to Scale

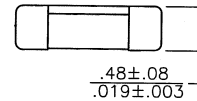
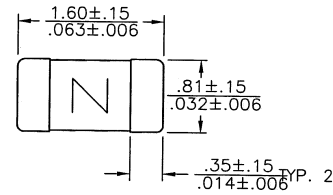

Land Pattern

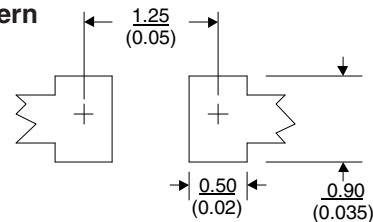

Soldering Method

- Wave Solder: 260°C, 10 sec max.
- Infrared Reflow: 260°C, 30 sec max.

SPECIFICATIONS

Product Code	Current Rating	Voltage Rating DC	Interrupting Rating at Rated Voltage*	DC Cold Resistance** (ohms) Typical	Typical Melting I ² t***	Typical Voltage Drop†	Alpha Code Marking‡
0603FA250-R	250mA	32V	50A	3.100	0.0004	0.921	D
0603FA375-R	375mA	32V	50A	1.250	0.0009	0.605	E
0603FA500-R	500mA	32V	50A	1.025	0.00193	0.600	F
0603FA750-R	750mA	32V	50A	0.450	0.0090	0.440	G
0603FA1-R	1A	32V	50A	0.150	0.0025	0.211	H
0603FA1.25-R	1.25A	32V	35A	0.108	0.0130	0.151	J
0603FA1.5-R	1.5A	32V	35A	0.086	0.0319	0.138	K
0603FA2-R	2A	32V	35A	0.051	0.0491	0.116	N
0603FA2.5-R	2.5A	24V	35A	0.037	0.0625	0.113	O
0603FA3-R	3A	24V	35A	0.028	0.0699	0.110	P
0603FA3.5-R	3.5A	24V	35A	0.022	0.1200	0.103	R
0603FA4-R	4A	24V	35A	0.017	0.2430	0.097	S
0603FA5-R	5A	24V	35A	0.011	0.6950	0.090	T

* DC Interrupting Rating (Measured at designated voltage, time constant of less than 50 microseconds, battery source)

** DC Cold Resistance (Measured at ≤10% of rated current)

*** Typical Melting I²t (Measured with a battery bank at rated DC voltage, 10x-rated current, not to exceed IR, time constant of calibrated circuit less than 50 microseconds) (0603FA4A and 5A measured at interrupting rating)

† Typical Voltage Drop (Measured at rated current after temperature stabilizes)

‡ Alpha code to be marked on the top of fuse body for all ratings

• Device designed to carry rated current for four hours minimum. An operating current of 80% or less of rated current is recommended, with further derating required at elevated ambient temperatures.

TIME CURRENT CURVE

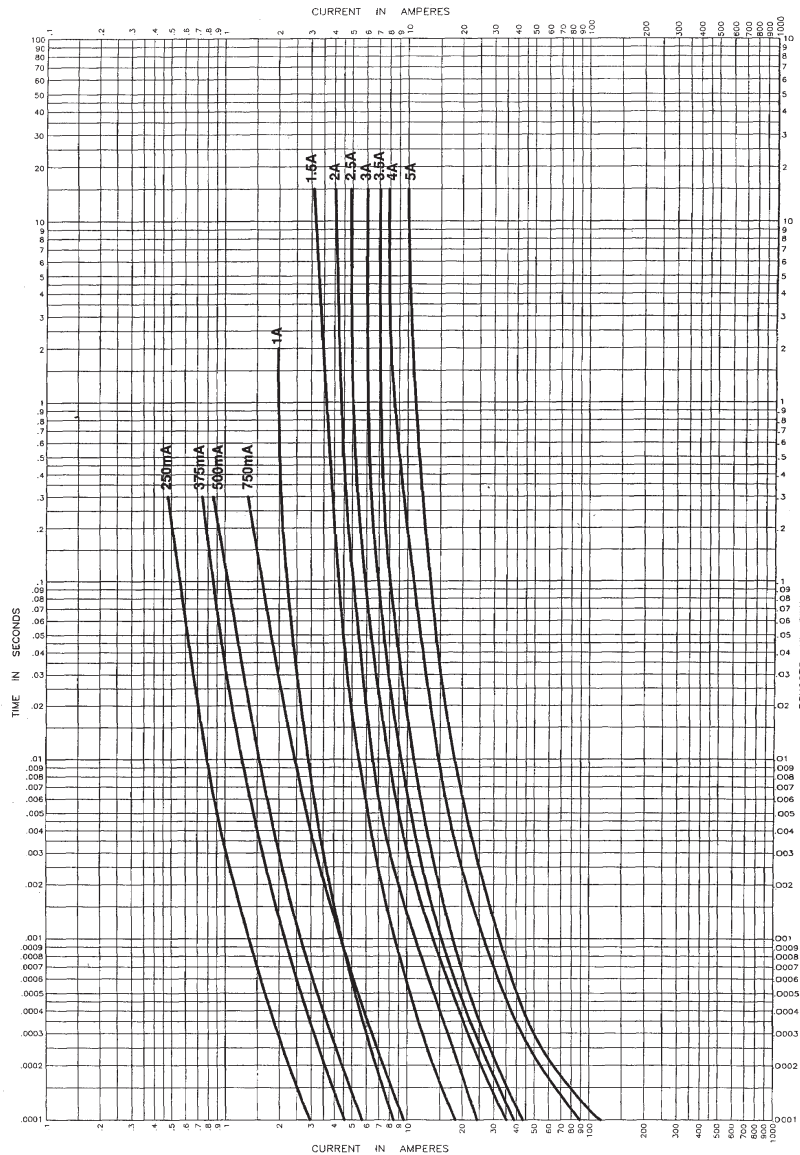

Printed Circuit Board Fuses - Surface Mount

PACKAGING CODE	
Packaging Code	Description
TR	5,000 pieces of fuses in paper tape and reeled on a 178mm (7 inch) reel per EIA Standard 481-1

Description

- Protects against harmful overcurrents in secondary applications
- High inrush withstand capability
- Wire-in-Air performance
- Compatible with leaded and lead-free reflow and wave solder

ELECTRICAL CHARACTERISTICS	
% of Amp Rating	Opening Time
100%	4 Hours Minimum
200%	1 sec. minimum, 120 sec. maximum
300%	0.05 sec. minimum, 3 sec. maximum
800%	0.002 sec. minimum, 0.05 sec. maximum

Agency Information

- **cRU** us Recognition File number: E19180, Volume 13

Environmental Data

- Thermal Shock: Withstands 5 cycles of -55°C & 125°C
- Vibration: MIL-STD-202F, Method 201A, Method 204D Condition D
- Solderability: ANSI/J-STD-002, Test B

Ordering

- Specify packaging and product code (i.e. TR/3216TD1-R)

Soldering Method

- Wave Immersion: 260°C, 10 sec max.
- Infrared Reflow: 260°C, 30 sec max.
- Hand Solder: 350°C, 3 sec max.

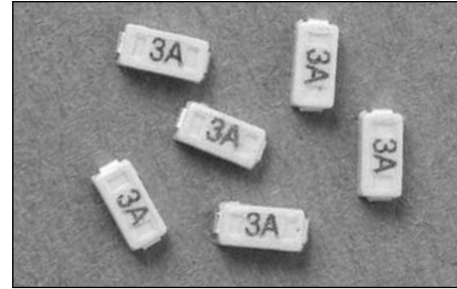

Dimensions mm/(inches)
Drawing Not to Scale

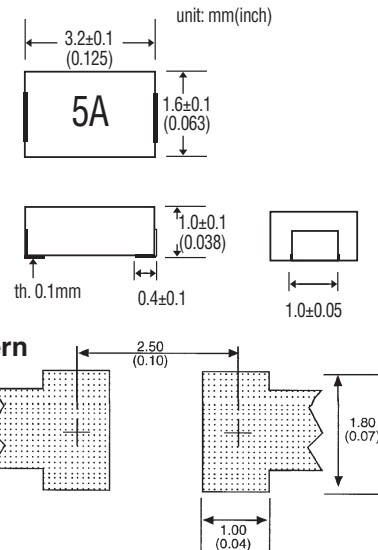

Printed Circuit Board Fuses - Surface Mount

SPECIFICATIONS

Product Code	Current Rating	Voltage Rating		Interrupting Rating* AC/DC	Resistance (ohms)** Typ.	Typical Melt I ^{††} DC	Typical Voltage Drop (V)‡
		AC	DC				
3216TD1-R	1A	63 V	63 V	50 A	0.075	0.32	75
3216TD1.5-R	1.5A	32 V	32 V	35 A	0.050	0.62	75
3216TD2-R	2A	32 V	32 V	35 A	0.030	1.30	60
3216TD2.5-R	2.5A	32 V	32 V	35 A	0.022	2.25	55
3216TD3-R	3A	32 V	32 V	35 A	0.018	3.30	55
3216TD4-R	4A	32 V	32 V	35 A	0.0165	5.20	56
3216TD5-R	5A	32 V	32 V	35 A	0.015	8.40	66
3216TD6.3-R	6.3A	32 V	32 V	35 A	0.0120	13.8	75
3216TD7-R	7A	32 V	32 V	35 A	0.0095	16.9	67
3216TD10-R	10A	32 V	32 V	35 A	0.006	54.4	65
3216TD12-R	12A	32 V	32 V	35 A	0.005	64.0	65

* AC Interrupting Rating (Measured at rated voltage with a unity power factor); DC Interrupting Rating (Measured at rated voltage, time constant of less than 50 microseconds, battery source)

** DC Cold Resistance (Measured at 10% of rated current)

† Typical Melting I^{††} (Measured with a battery bank at rated DC voltage, 10x-rated current at 1 microsecond, not to exceed IR. Above 7a uses 70 micron thickness copper layer test board of IEC 60127-3. Others uses 35 micron thickness copper layer.)

‡ Typical Voltage Drop (Measured at rated current after temperature stabilizes)

Device designed to carry rated current for four hours minimum. An operating current of 80% or less of rated current is recommended, with further derating required at elevated ambient temperatures.

TIME CURRENT CURVE

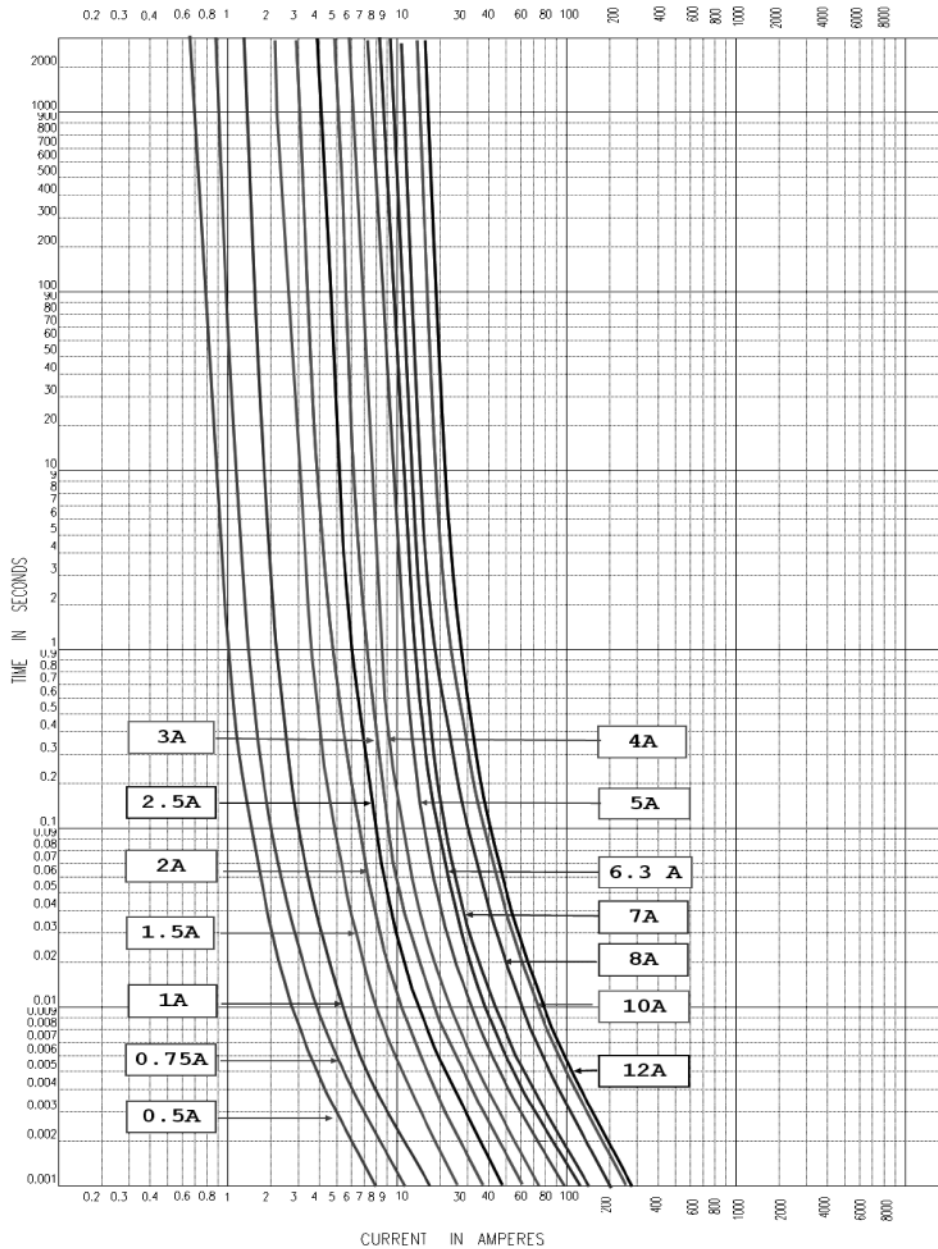

Printed Circuit Board Fuses - Surface Mount

PACKAGING CODE

Packaging Code	Description
TR	2,500 pieces of fuses on 12mm tape-and-reel on a 180mm reel per EIA-481-A & IEC286-3

Description

- Fast acting surface mount fuse
- Ratings up to 20A
- Excellent temperature and cycling characteristics
- Compatible with reflow and wave solder

Agency Information

ELECTRICAL CHARACTERISTICS		
Ampere Rating	% of Amp Rating	Opening Time
250mA - 7A	100%	4 Hours Minimum
1.25A - 3A	200%	60 Seconds Maximum
250mA - 3A	250%	5 Second Maximum
4A - 7A	350%	1 Second Maximum
15A - 20A	350%	5 Second Maximum

- UL Recognition Guide & File numbers: JDYX2 & E19180.
- CSA Component Acceptance: 053787 C 000 & Class No: 1422 30.
-  us Recognition File number: E19180 (15A - 20A)

Environmental Data

- Thermal Shock: MIL-STD-202, Method 107, Test Condition B
- Vibration: MIL-STD-202, Method 204, Test Condition C
- Moisture Resistance: MIL-STD-202, Method 106, 10 day cycle
- Solderability: ANSI/J-STD-002, Test B

Ordering

- Specify packaging and product code (i.e. TR/3216FF250-R)

Soldering Method

- Wave Immersion: 260°C, 10 sec max.
- Infrared Reflow: 260°C, 30 sec max.

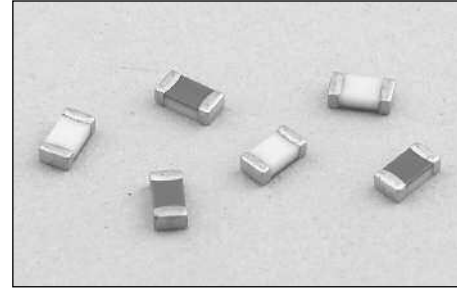

Dimensions mm/(inches)
Drawing Not to Scale

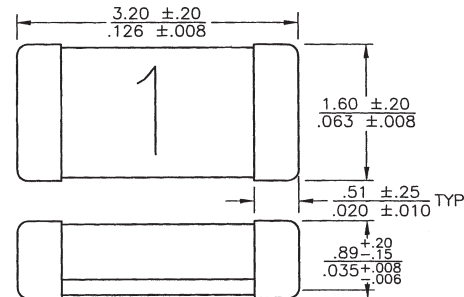

Land Pattern

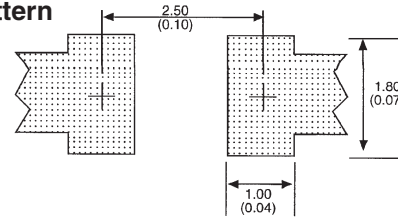

SPECIFICATIONS

Product Code	Current Rating	Voltage Rating		Interrupting Rating* AC/DC	Resistance (ohms)** Typ.	Typical Melt I ² t† DC	Typical Voltage Drop (V)‡
		AC	DC				
3216FF250-R	250mA	32 V	63 V	50 A	3.0	0.00038	1.4
3216FF375-R	375mA	32 V	63 V	50 A	1.75	0.00077	0.73
3216FF500-R	500mA	32 V	63 V	50 A	0.98	0.0019	0.66
3216FF750-R	750mA	32 V	63 V	50 A	0.50	0.0053	0.63
3216FF1-R	1A	32 V	63 V	50 A	0.24	0.030	0.20
3216FF1.25-R	1.25A	32 V	63 V	50 A	0.135	0.060	0.19
3216FF1.5-R	1.5A	32 V	63 V	50 A	0.119	0.093	0.18
3216FF2-R	2A	32 V	63 V	50 A	0.066	0.126	0.16
3216FF2.5-R	2.5A	32 V	63 V	50 A	0.046	0.260	0.14
3216FF3-R	3A	32 V	63 V	50 A	0.040	0.275	0.13
3216FF4-R	4A	32 V	32 V	50 A	0.018	0.337	0.11
3216FF4.5-R	4.5A	32 V	32 V	50 A	0.016	0.405	0.10
3216FF5-R	5A	32 V	32 V	50 A	0.014	0.534	0.09
3216FF6.5-R	6.5A	32 V	32 V	50 A	0.0082	2.294	0.076
3216FF7-R	7A	32 V	32 V	50 A	0.0078	3.623	0.078
3216FF15-R	15A	24 V	24 V	150 A	0.0031	25.5	0.065
3216FF20-R	20A	24 V	24 V	150 A	0.0018	48.6	0.058

* AC Interrupting Rating (Measured at rated voltage with a unity power factor); DC Interrupting Rating (Measured at rated voltage, time constant of less than 50 microseconds, battery source)

** DC Cold Resistance (Measured at 10% of rated current)

† Typical Melting I²t (Measured with a battery bank at rated DC voltage, 10x-rated current, not to exceed IR, time constant of calibrated circuit less than 50 microseconds) (6.5A & 7A measured at interrupting rating)

‡ Typical Voltage Drop (Measured at rated current after temperature stabilizes)

It is recommended that fuses be mounted with ceramic (white) side facing up.

Device designed to carry rated current for four hours minimum. An operating current of 80% or less of rated current is recommended, with further derating required at elevated ambient temperatures.

TIME CURRENT CURVE

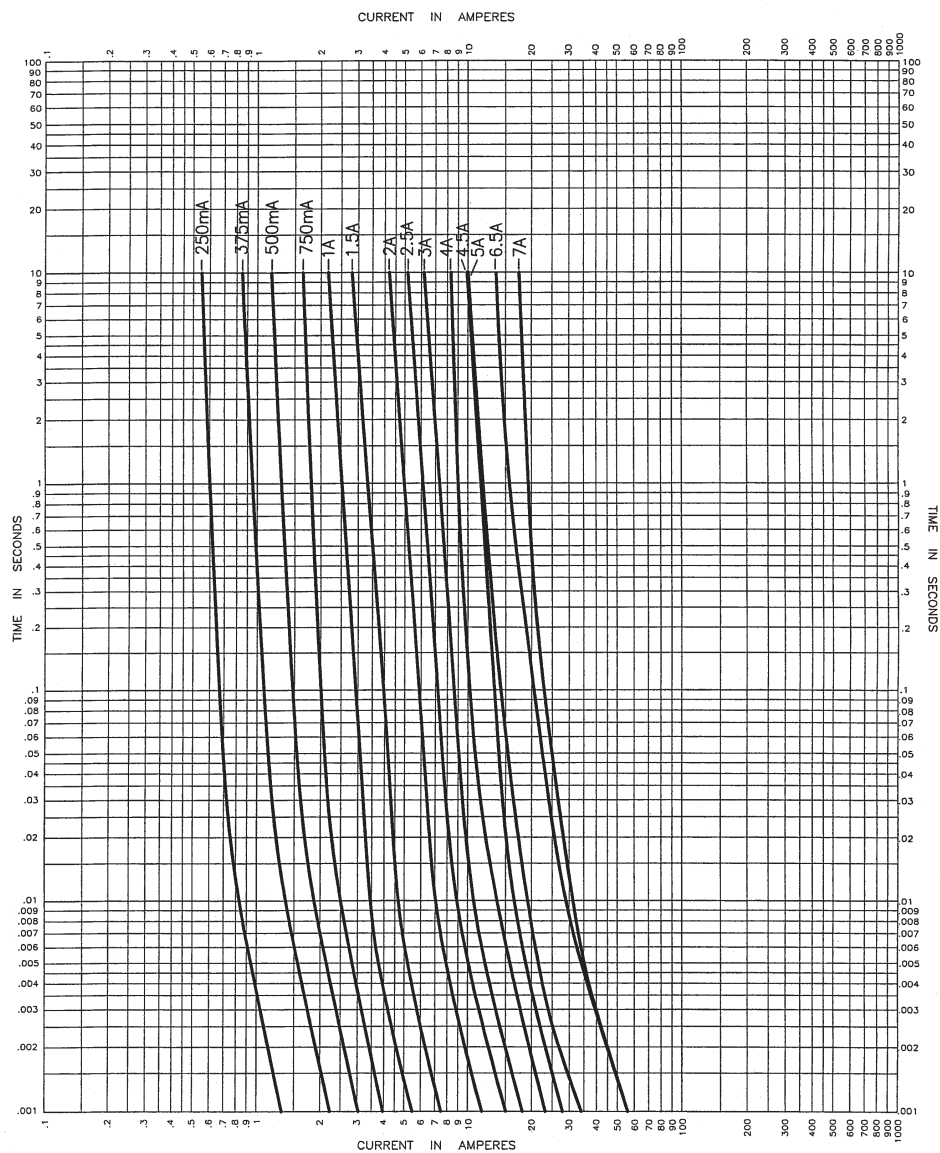

Printed Circuit Board Fuses - Surface Mount

PACKAGING CODE

Packaging Code	Description
TR	3,000 pieces of fuses on 8mm tape-and-reel on a 7 inch (178mm) reel per EIA Standard 481

Description

- Surface mount fuse, fast acting, 125 VAC
- Utilize thick and thin metal film technologies for superior fusing action and enhanced reliability.

ELECTRICAL CHARACTERISTICS	
% of Amp Rating	Opening Time
100%	4 hours minimum
250%	5 seconds maximum

Agency Information

- UL Recognition Guide & File numbers: JDYX2 & E19180.
- CSA Component Acceptance: 053787 C 000 & Class No: 1422 30.

Environmental Data

- Operating Temperature Range: -65 to +125°C, with proper derating
- Thermal Shock: MIL-STD-202, Method 107, Test Condition B (-65 to 125°C), 1000 cycles, fuses soldered to FR-4 glass-epoxy circuit board
- Vibration: MIL-STD-202, Method 204, Test Condition C (55 to 2000 HZ, 10G)
- Solderability: Withstands 60 seconds above 200°C, 260°C maximum
- Moisture Resistance: MIL-STD-202, Method 106, 10 day cycle
- Solder Leach Resistance & Terminal Adhesion: EIA-576 (30 seconds submersion in 260°C tin-lead solder)

Ordering

- Specify packaging and product code (i.e. TR/3216LV1-R)

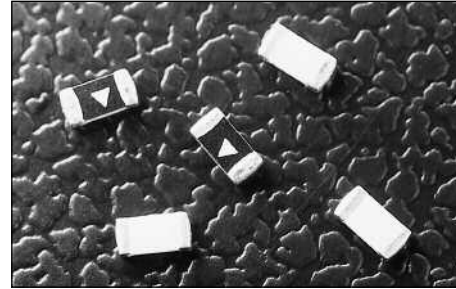

Dimensions mm/(inches)
Drawing Not to Scale

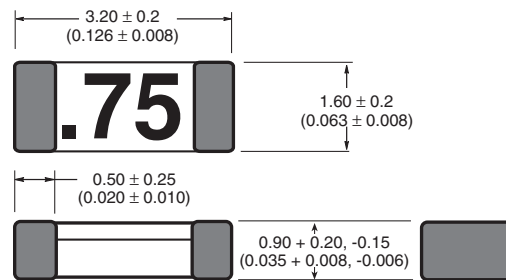

Land Pattern

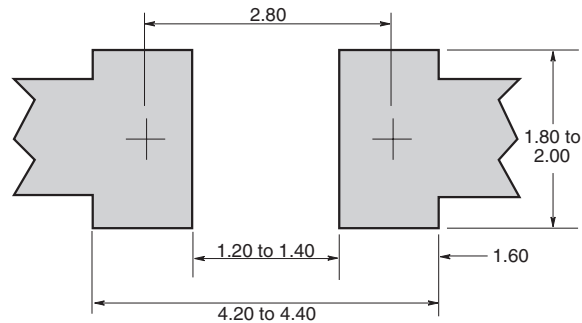

SPECIFICATIONS

Product Code	Current Rating	Voltage Rating AC/DC	Interrupting Rating 125V AC/DC	Typical Melting Integral @ 10X Rated Current (A² * sec)		Typ. Resistance @ ≤ 10% Rated Current (Ohms)	Typ. Voltage Drop @ Rated Current (Volts)
				AC	DC		
3216LV250-R	250mA	125V	50A	.00016	.000084	4.5	1.4
3216LV375-R	375mA	125V	50A	.001	.0002	1.80	.73
3216LV500-R	500mA	125V	50A	.0014	.0019	1.15	.66
3216LV750-R	750mA	125V	50A	.0033	.00379	.75	.63
3216LV1-R	1A	125V	50A	.020	.0084	.52	.63
3216LV1.25-R	1.25A	125V	50A	.035	.021	.40	.62
3216LV1.5-R	1.5A	125V	50A	.038	.024	.26	.49

Notes:

1. AC interrupting rating, melting integral and total clearing integral measured at 125V, unity power factor
2. DC interrupting rating, melting integral and total clearing integral measured at 125V with a battery source
3. Voltage drop measured at 23 ± 3°C ambient temperature with the device mounted on a suitable circuit board trace
4. It is recommended that fuses be mounted with ceramic (white) side facing up
5. Device designed to carry rated current for four hours minimum. An operating current of 80% or less of rated current is recommended, with further derating required at elevated ambient temperatures

TIME CURRENT CURVE

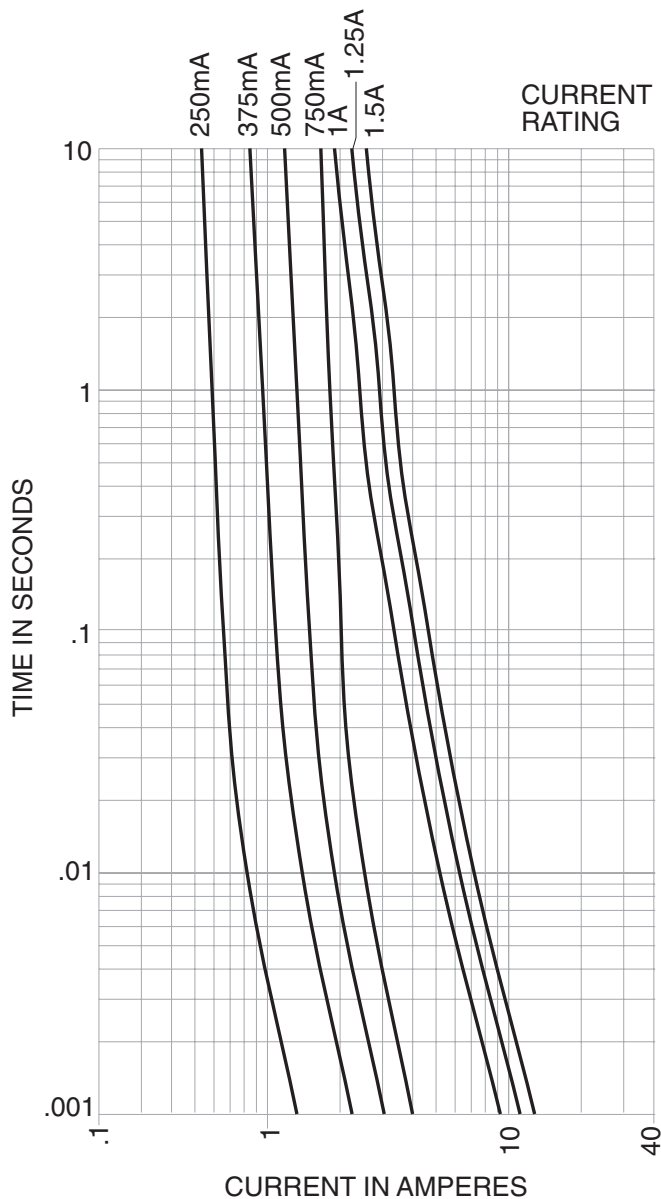

Printed Circuit Board Fuses - Surface Mount

PACKAGING CODE

Packaging Code	Description
TR	3,000 pieces of fuses on 8mm tape-and-reel on a 7 inch (178mm) reel per EIA Standard 481

Description

- Time Delay surface mount fuse
- Complies with EIA-IS-722 Standard
- Solder Immersion Compatible

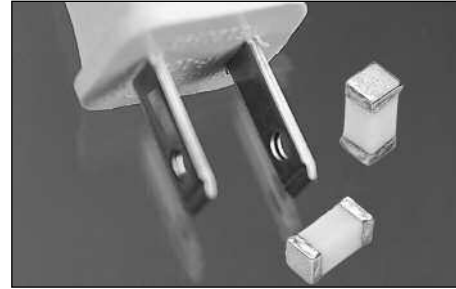

ELECTRICAL CHARACTERISTICS	
% of Amp Rating	Opening Time
100%	4 Hours Minimum
200%	1 Second Minimum
200%	2-4 Seconds Typical
200%	60 Seconds Maximum

Agency Information

- UL Recognition Guide & File numbers: JDYX2 & E19180.
- CSA Component Acceptance: 053787 C 000 & Class No: 1422 30.

Environmental Data

- Life Test: MIL-STD-202, Method 108A, Test Condition D
- Load Humidity: MIL-STD-202, Method 103B
- Moisture Resistance: MIL-STD-202, Method 106E
- Thermal Shock: MIL-STD-202, Method 107D, air-to-air
- Case Resistance: EIA/IS-722
- Resistance to Dissolution of Metallization: ANSI J-STD-002, Test D
- Mechanical Shock: MIL-STD-202, Method 213B, Test Condition A
- High Frequency Vibration: MIL-STD-202, Method 204D, Test Condition D
- Resistance to Solvents: MIL-STD-202, Method 215A

Ordering

- Specify packaging and product code (i.e., TR1/6125TD500-R)

Dimensions mm/(inches)

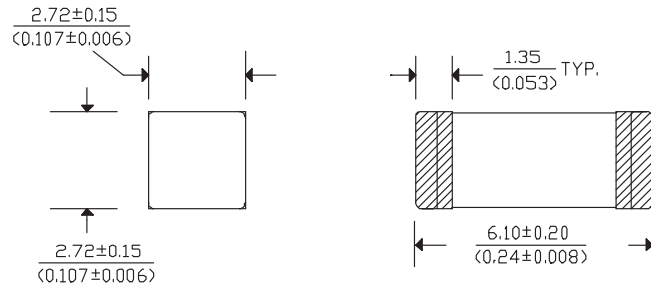

Land Pattern

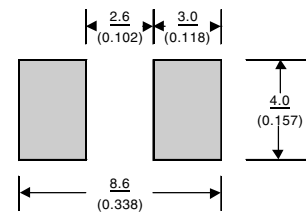

Soldering Method

- Wave Immersion: 260°C, 10 sec max.
- Infrared: 260°C, 30 sec max.

SPECIFICATIONS

Product Code	Current Rating	Voltage Rating		Interrupting Rating*		Resistance (ohms)** Typ.	Typical Melting I [†] t	Typical Voltage Drop‡
		AC	DC	125VAC	60VDC			
6125TD500-R	500mA	125V	60V	50A	50A	0.4025	0.716	245 mV
6125TD750-R	750mA	125V	60V	50A	50A	0.2350	1.07	250 mV
6125TD1-R	1A	125V	60V	50A	50A	0.1680	2.88	256 mV
6125TD1.5-R	1.5A	125V	60V	50A	50A	0.0630	2.35	125 mV
6125TD2-R	2A	125V	60V	50A	50A	0.0480	9.45	133 mV
6125TD2.5-R	2.5A	125V	60V	50A	50A	0.0350	16.2	130 mV
6125TD3-R	3A	125V	60V	50A	50A	0.0263	15.3	97 mV
6125TD3.5-R	3.5A	125V	60V	50A	50A	0.0195	14.5	95 mV
6125TD4-R	4A	125V	60V	50A	50A	0.0185	38.8	106 mV
6125TD5-R	5A	125V	60V	50A	50A	0.0133	34.4	100 mV
6125TD7-R	7A	125V	60V	50A	50A	0.0087	90.2	99 mV

* AC Interrupting Rating (Measured at designated voltage, 100% power factor); DC Interrupting Rating (Measured at designated voltage, time constant of less than 50 microseconds, battery source)

** DC Cold Resistance (Measured at 10% of rated current)

† Typical Melting I[†]t (Measured with a battery bank at rated DC voltage, 10x-rated current (not to exceed IR), time constant of calibrated circuit less than 50 microseconds)

‡ Typical Voltage Drop (Measured at rated current after temperature stabilizes)

Device designed to carry rated current for four hours minimum. An operating current of 80% or less of rated current is recommended, with further derating required at elevated ambient temperatures.

TIME CURRENT CURVE

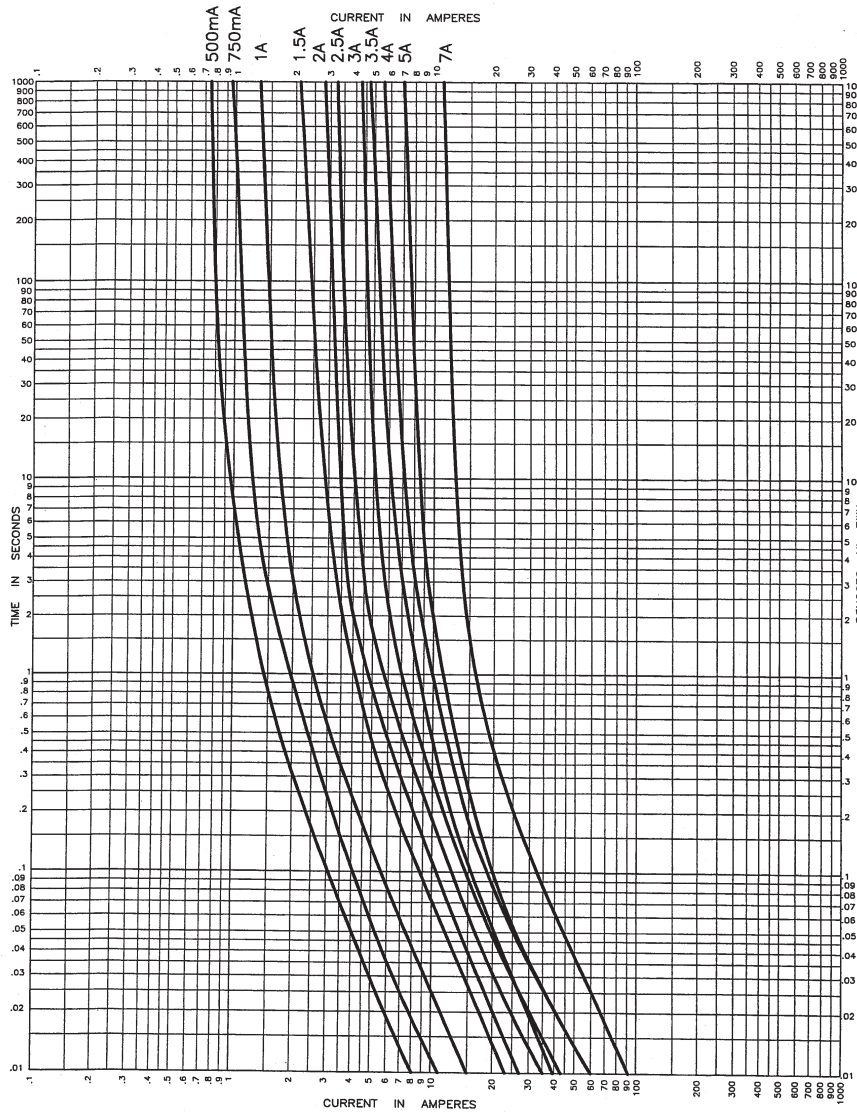

Printed Circuit Board Fuses - Surface Mount

PACKAGING CODE	
Packaging Code	Description
TR1	1,000 pieces of fuses on 12mm tape-and-reel on a 7 inch (177mm) reel per EIA Standard 481

Description

- Fast Acting Surface Mount Fuse
- Overcurrent protection of systems up to 125VAC/72VDC
- High inrush withstand capability
- Solder immersion compatible

ELECTRICAL CHARACTERISTICS	
% of Amp Rating	Opening Time
100%	4 Hours Minimum
200%	5 Second Maximum

Agency Information

-  Recognition File number: E19180

Environmental Data

- Operating Temperature: -55°C to 125°C
- Mechanical Shock: MIL-STD-202, Method 213
- High Frequency Vibration: MIL-STD-202, Method 204
- Load Humidity: MIL-STD-202, Method 103
- Moisture Resistance: MIL-STD-202, Method 106
- Resistance to Solvents: MIL-STD-202, Method 215
- Thermal Shock: MIL-STD-202, Method 107

Ordering

- Specify packaging and product code (i.e., TR2/6125FF500-R)

Soldering Method

- Wave Immersion: 260°C, 10 sec max.
- Infrared: 260°C, 30 sec max.

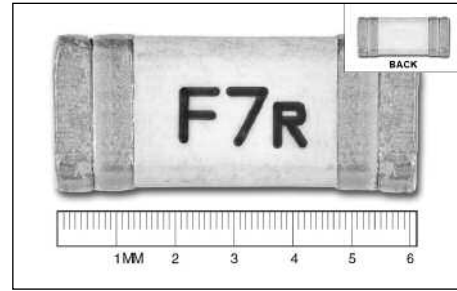

Dimensions mm/(inches)

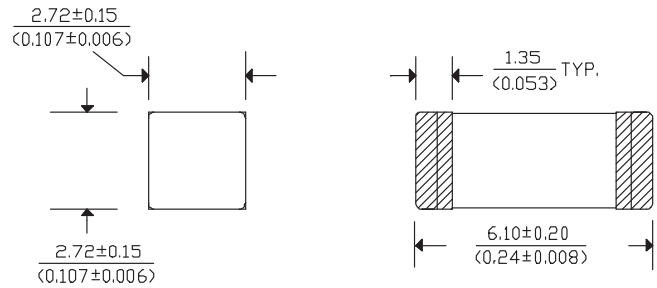

Land Pattern

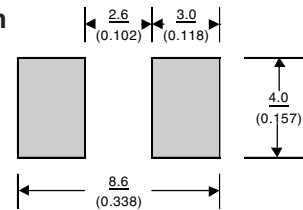

Printed Circuit Board Fuses - Surface Mount

SPECIFICATIONS

Part Number	Voltage Rating		Interrupting Rating			DC Cold Resistance (milliohms) Typ.	Melting I²t (A² sec)	Typical Voltage Drop (mV)
	AC	DC	125V AC	72V DC	32V DC			
6125FF500-R	125V	72V	50A	50A	300A	1130	0.090	935
6125FF750-R	125V	72V	50A	50A	300A	350	0.152	433
6125FF1-R	125V	72V	50A	50A	300A	260	0.180	415
6125FF1.25-R	125V	72V	50A	50A	300A	171	0.355	410
6125FF1.5-R	125V	72V	50A	50A	300A	112	0.456	365
6125FF2-R	125V	72V	50A	50A	300A	49	1.67	160
6125FF2.5-R	125V	72V	50A	50A	300A	45	5.20	155
6125FF3-R	125V	72V	50A	50A	300A	35	8.00	153
6125FF3.5-R	125V	72V	50A	50A	300A	27	15.00	150
6125FF4-R	125V	72V	50A	50A	300A	26	15.80	145
6125FF5-R	125V	72V	50A	50A	300A	17	17.20	141
6125FF6.3-R	125V	72V	50A	50A	300A	14	22.50	135
6125FF7-R	125V	72V	50A	50A	300A	11	37.25	112
6125FF10-R	125V	72V	50A	50A	300A	7.3	67.75	110
6125FF12-R	125V	72V	50A	50A	300A	5.3	210.59	106
6125FF15-R	125V	72V	50A	50A	300A	4.2	296.10	104

* AC Interrupting Rating (Measured at designated voltage, 100% power factor); DC Interrupting Rating (Measured at designated voltage, time constant of less than 50 microseconds, battery source)
 ** Typical Melting I²t (Measured at 72Vdc, 10X rated current (not exceed 50A - IR @ 72Vdc))

TIME CURRENT CURVE

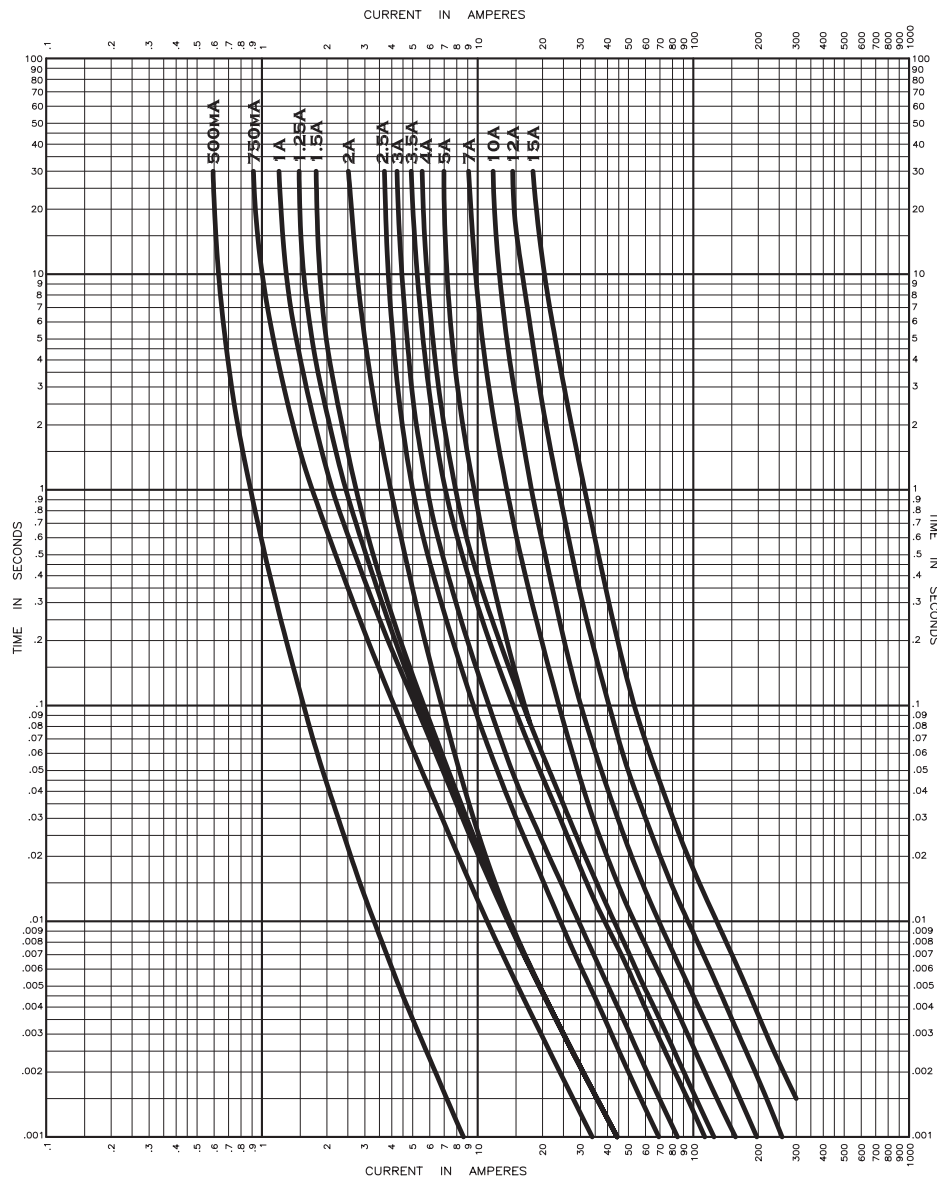

Printed Circuit Board Fuses - Surface Mount

PACKAGING CODE	
Packaging Code TR2	Description 5,000 pieces of fuses on tape-and-reel on a 13 inch (330mm) reel

Description

- Fast Acting Surface Mount Fuse
- Complies with the EIA-188 Standard
- Solder Immersion Compatible
- Overcurrent protection of systems up to 125VAC/DC
- Wire-in-air design

ELECTRICAL CHARACTERISTICS	
% of Amp Rating	Opening Time
100%	4 Hours Minimum
200%	5 Seconds Maximum

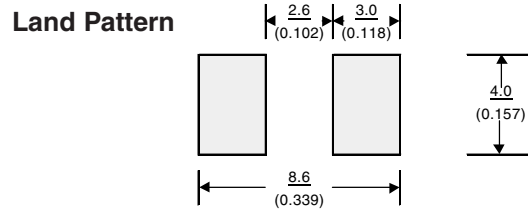
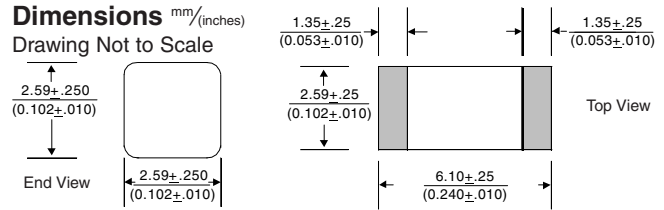
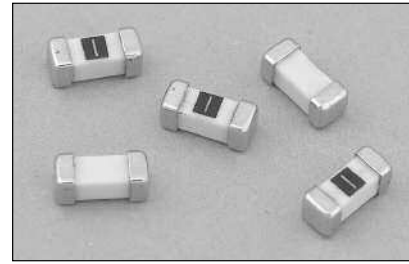

Soldering Method

- Wave Solder: 260°C, 10 sec max. (MIL-STD-202, Method 210)
- Infrared Reflow: 260°C, 30 sec max.

Agency Information

- UL Listed Guide and File Numbers (250mA-12A): JDYX & E19180
- UL Recognized Guide and File Numbers (15A): JDYX2 & E195337
- CSA Component Acceptance: 053787 C 000 & Class No: 1422 30

Environmental Data

- Shock: MIL-STD-202, Method 213, Test Condition 1 (100 G's peak for 6 milliseconds)
- Vibration: MIL-STD-202, Method 201 (10-55 Hz, 0.06 inch, total excursion)
- Salt Spray: MIL-STD-202, Method 101, Test Condition B (48 hrs)
- Insulation Resistance: MIL-STD-202, Method 302, Test Condition A (After Opening) 10,000 ohms minimum
- Resistance to Solder Heat: MIL-STD-202, Method 210, Test Condition F (20 sec, at 260° C)
- Thermal Shock: MIL-STD-202, Method 107, Test Condition B (-65° C to +125° C)

Ordering

- Specify product and packaging code

SPECIFICATIONS

Product Code	Voltage Rating			Interrupting Rating*			Resistance (ohms)** Typ.	Typical Melt I ² t†	Typical Voltage Drop (V)‡
	AC	DC	DC	125V AC	125V DC	86V DC			
6125FA250mA	125V	125V	86V	50A	300A	10,000A	0.65	0.01	0.30
6125FA375mA	125V	125V	86V	50A	300A	10,000A	0.36	0.03	0.25
6125FA500mA	125V	125V	86V	50A	300A	10,000A	0.24	0.06	0.22
6125FA750mA	125V	125V	86V	50A	300A	10,000A	0.15	0.07	0.17
6125FA1A	125V	125V	86V	50A	300A	10,000A	0.11	0.14	0.17
6125FA1.25A	125V	125V	86V	50A	300A	10,000A	0.09	0.24	0.16
6125FA1.5A	125V	125V	86V	50A	300A	10,000A	0.07	0.41	0.15
6125FA2A	125V	125V	86V	50A	300A	10,000A	0.05	0.80	0.15
6125FA2.5A	125V	125V	86V	50A	300A	10,000A	0.038	1.4	0.14
6125FA3A	125V	125V	86V	50A	300A	10,000A	0.028	2.4	0.13
6125FA3.5A	125V	125V	86V	50A	300A	10,000A	0.025	3.3	0.13
6125FA4A	125V	125V	86V	50A	300A	10,000A	0.022	4.4	0.13
6125FA5A	125V	125V	86V	50A	300A	10,000A	0.016	7.8	0.12
6125FA6.3A	125V	125V	86V	50A	300A	10,000A	0.012	14.0	0.12
6125FA7A	125V	125V	86V	50A	300A	10,000A	0.011	19.0	0.114
6125FA10A	125V	N/A	86V	50A	N/A	10,000A	0.007	44	0.107
6125FA12A	125V	N/A	86V	50A	N/A	10,000A	0.006	69	0.103
6125FA15A	N/A	N/A	86V	N/A	N/A	10,000A	0.004	124	0.098

* AC Interrupting Rating (Measured at designated voltage, 100% power factor); DC Interrupting Rating (Measured at designated voltage, time constant of less than 50 microseconds, battery source)

** DC Cold Resistance (Measured at 10% of rated current)

† Typical Melting I²t (Measured with a battery bank at rated DC voltage, 10x-rated current, time constant of calibrated circuit less than 50 microseconds)

‡ Typical Voltage Drop (Measured at rated current after temperature stabilizes)

Device designed to carry rated current for four hours minimum. An operating current of 80% or less of rated current is recommended, with further derating required at elevated ambient temperatures.

TIME CURRENT CURVE

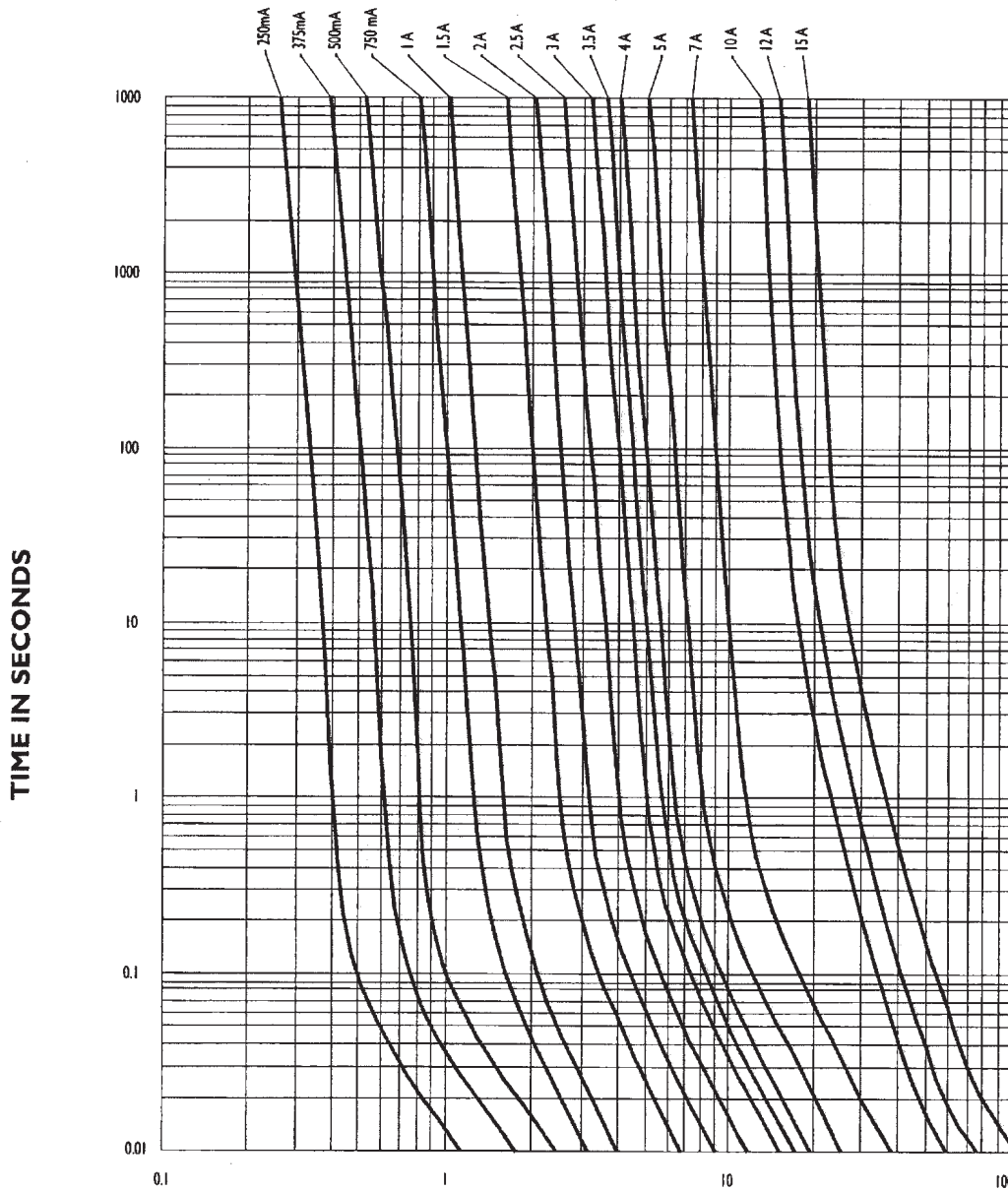

Printed Circuit Board Fuses - Surface Mount

PACKAGING CODE

Packaging Code	Description
TR2	5,000 pieces of fuses on 12mm tape-and-reel on a 13 inch (330mm) reel per EIA Standard 481

Description

- Time Delay Surface Mount Fuse
- Satisfies the EIA/IS-722 Standard
- Solder Immersion Compatible

ELECTRICAL CHARACTERISTICS	
% of Amp Rating	Opening Time
100%	4 Hours Minimum
200%	1 Second Minimum
200%	60 Seconds Maximum
250% *	10 Seconds Maximum

* If fuse does not open @ 200% in 60 seconds, raise current to 250% and the fuse must open in 10 seconds maximum.

Agency Information

- UL Recognition Guide & File numbers: JDYX2 & E19180 (250mA - 5A)
- CSA Component Acceptance: File # 053787 C000, Class # 1422 30

Environmental Data

- Life Test: MIL-STD-202, Method 108A, Test Condition D
- Load Humidity: MIL-STD-202, Method 103B
- Moisture Resistance: MIL-STD-202, Method 106E
- Terminal Strength: MIL-STD-202, Method 211A
- Thermal Shock: MIL-STD-202, Method 107D, air-to-air
- Case Resistance: EIA/IS-722
- Resistance to Dissolution of Metallization: ANSI J-STD-002, Test D
- Mechanical Shock: MIL-STD-202, Method 213B with exceptions per EIA/IS-722 Standard
- High Frequency Vibration: MIL-STD-202, Method 204D, Test Condition D
- Resistance to Solvents: MIL-STD-202, Method 215A



Dimensions mm/(inches)
Drawing Not to Scale

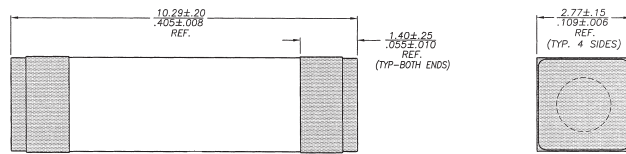

Land Pattern

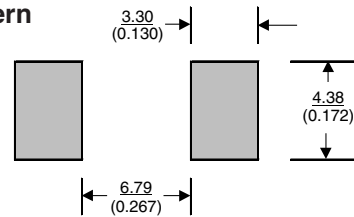

Ordering

- Specify packaging and product code (i.e., TR2/1025TD250-R)

Soldering Method

- Wave Immersion: 260°C, 10 sec max.
- Infrared: 260°C, 30 sec max.

SPECIFICATIONS

Product Code	Current Rating	Voltage Rating		Interrupting Rating*		DC Cold Resistance** (ohms) Typical	Typical Melting I ^{††}	Typical Voltage Drop‡
		AC	DC	250VAC	125VDC			
1025TD250-R	250mA	250V	125V	50A	50A	4.200	0.128	1900 mV
1025TD500-R	500mA	250V	125V	50A	50A	0.5500	1.47	455 mV
1025TD750-R	750mA	250V	125V	50A	50A	0.317	0.93	400 mV
1025TD1-R	1A	250V	125V	50A	50A	0.2030	9.91	387 mV
1025TD1.5-R	1.5A	250V	125V	50A	50A	0.1025	11.79	310 mV
1025TD2-R	2A	250V	125V	50A	50A	0.0680	17.27	250 mV
1025TD2.5-R	2.5A	250V	125V	50A	50A	0.0420	16.51	201 mV
1025TD3-R	3A	250V	125V	50A	50A	0.0330	42.74	184 mV
1025TD3.5-R	3.5A	250V	125V	50A	50A	0.0270	43.33	180 mV
1025TD4-R	4A	250V	125V	50A	50A	0.0220	66.96	152 mV
1025TD5-R	5A	250V	125V	50A	50A	0.0160	88.38	145 mV

* AC Interrupting Rating (Measured at designated voltage, 100% power factor random closing); DC Interrupting Rating (Measured at designated voltage, time constant of the calibrated circuit is less than 50 microseconds, battery source)

** DC Cold Resistance (Measured at ≤10% of rated current)

† Typical Melting I^{††} (Measured with a battery bank at rated DC voltage, 10x-rated current, time constant of calibrated circuit less than 50 microseconds)

‡ Typical Voltage Drop (Measured at rated current after temperature stabilizes)

‡‡ Marking Code - 3rd (U = USA, T = Taiwan and S = China)

• Device designed to carry rated current for four hours minimum. An operating current of 80% or less of rated current is recommended, with further derating required at elevated ambient temperatures.

TIME CURRENT CURVE

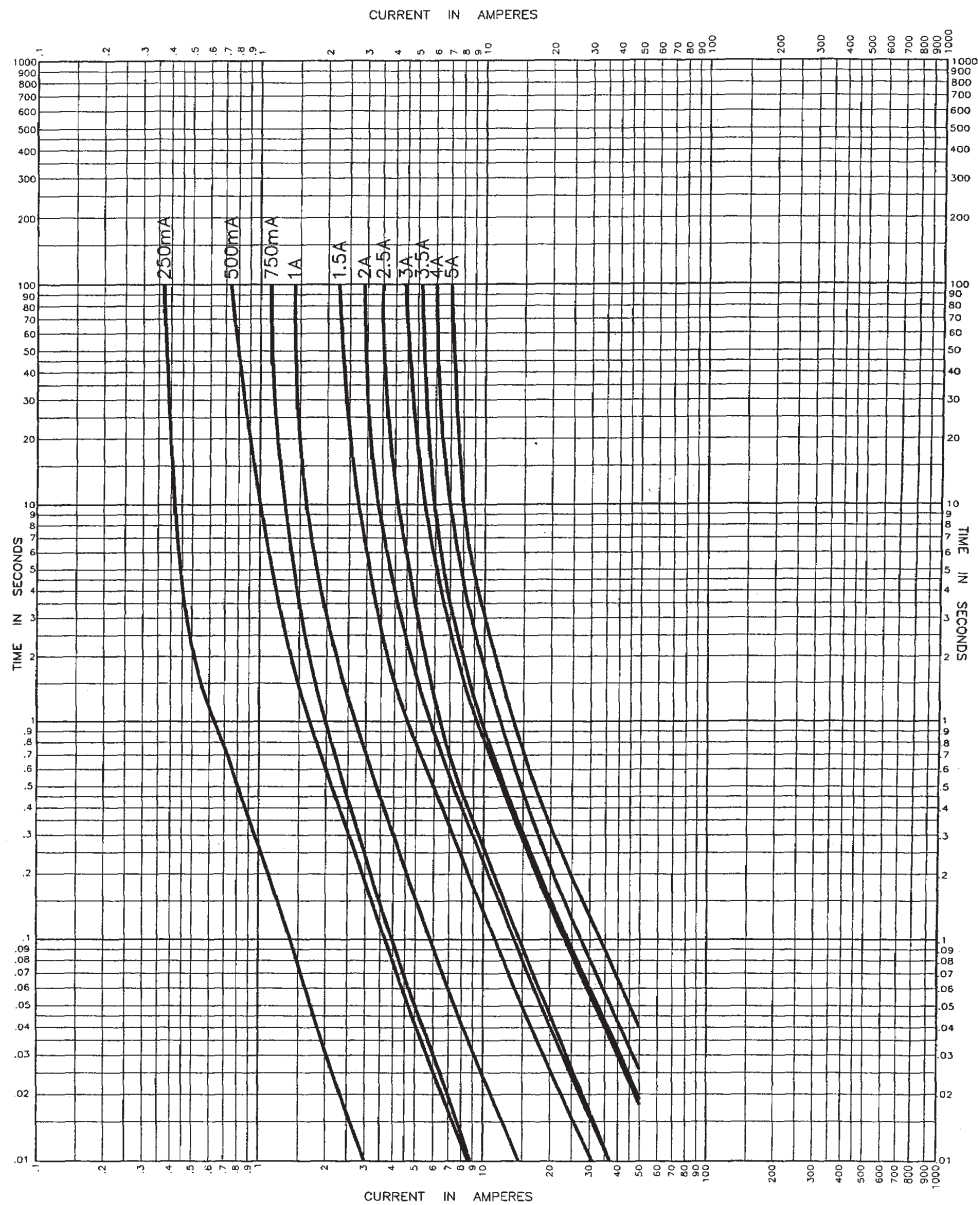

Printed Circuit Board Fuses - Surface Mount

PACKAGING CODE	
Packaging Code	Description
TR2	2,500 pieces of fuses on 24mm tape-and-reel on 13 inch (330mm) reel per EIA Standard 481

Description

- Fast Acting Surface Mount Fuse
- Satisfies the EIA/IS-722 Standard
- Solder Immersion Compatible

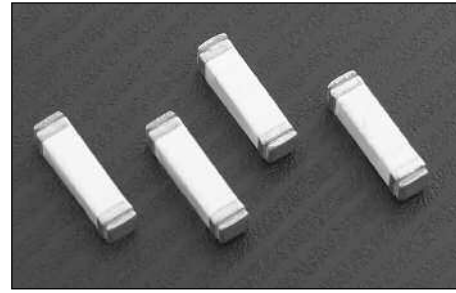

ELECTRICAL CHARACTERISTICS	
% of Amp Rating	Opening Time
100%	4 Hours Minimum
200% (250mA-5A)	5 Seconds Maximum
250% (250mA-5A fuse)	1 Second Maximum
200% (7A-15A fuse)	20 Seconds Maximum
250% (7A-15A fuse)	4 Seconds Maximum

Note: 30vdc constant current source required for 200% overload tests on 250ma-1a.

Agency Information

- UL Recognition Guide & File numbers: JDYX2 & E19180 (250mA - 15A)
- CSA Component Acceptance: File # 053787 C000, Class # 1422 30

Environmental Data

- Life Test: MIL-STD-202, Method 108A, Test Condition D
- Load Humidity: MIL-STD-202, Method 103B
- Moisture Resistance: MIL-STD-202, Method 106E
- Terminal Strength: MIL-STD-202, Method 211A
- Thermal Shock: MIL-STD-202, Method 107D, air-to-air
- Case Resistance: EIA/IS-722
- Resistance to Dissolution of Metallization: ANSI J-STD-002, Test D
- Mechanical Shock: MIL-STD-202, Method 213B with exceptions per EIA/IS-722 Standard
- High Frequency Vibration: MIL-STD-202, Method 204D, Test Condition D
- Resistance to Solvents: MIL-STD-202, Method 215A

Dimensions mm/(inches)
Drawing Not to Scale

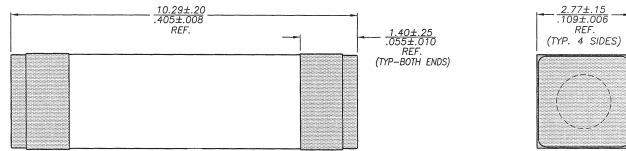

Land Pattern

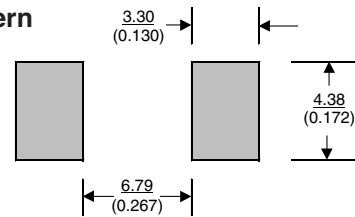

Ordering

- Specify packaging and product code (i.e., TR2/1025FA250-R)

Soldering Method

- Wave Solder: 260°C, 10 sec max.
- Infrared Reflow: 260°C, 30 sec max.

SPECIFICATIONS

Product Code	Current Rating	Voltage Rating		Interrupting Rating*			DC Cold Resistance** (ohms) Typical	Typical Melting I [†]	Typical Voltage Drop‡
		AC	DC	250VAC	125VDC	60VDC			
1025FA250-R	250mA	250V	125V	50A	50A	-	5.0000	0.1212	2019 mV
1025FA500-R	500mA	250V	125V	50A	50A	-	1.2000	0.0415	1500 mV
1025FA750-R	750mA	250V	125V	50A	50A	-	0.6000	0.143	880 mV
1025FA1-R	1A	250V	125V	50A	50A	-	0.3000	1.750	560 mV
1025FA1.5-R	1.5A	250V	125V	50A	50A	-	0.1040	1.460	260 mV
1025FA2-R	2A	250V	125V	50A	50A	-	0.0800	6.086	258 mV
1025FA2.5-R	2.5A	250V	125V	50A	50A	-	0.0510	8.48	232 mV
1025FA3-R	3A	250V	125V	50A	50A	-	0.0390	18.15	205 mV
1025FA3.5-R	3.5A	250V	125V	50A	50A	-	0.0300	17.83	185 mV
1025FA4-R	4A	250V	125V	50A	50A	-	0.0270	23.32	190 mV
1025FA5-R	5A	250V	125V	50A	50A	-	0.0200	38.74	180 mV
1025FA7-R	7A	250V	60V	50A	50A	-	0.0116	138	150 mV
1025FA10-R	10A	250V	60V	50A	50A	-	0.0076	457	146 mV
1025FA12-R	12A	250V	60V	50A	-	50A	0.0550	498	120 mV
1025FA15-R	15A	250V	60V	50A	-	50A	0.0041	1451	110 mV

* AC Interrupting Rating (Measured at designated voltage, 100% power factor random closing); DC Interrupting Rating (Measured at designated voltage, time constant of less than 50 microseconds, battery source)

** DC Cold Resistance (Measured at ≤10% of rated current)

† Typical Melting I[†] (Measured with a battery bank at rated DC voltage, 10x-rated current, but not exceeding the interrupting rating. Time constant of calibrated circuit less than 50 microseconds). Test current not to exceed interrupting rating of 50A.

‡ Typical Voltage Drop (Measured at rated current after temperature stabilizes)

• Device designed to carry rated current for four hours minimum. An operating current of 80% or less of rated current is recommended, with further derating required at elevated ambient temperatures.

TIME CURRENT CURVE

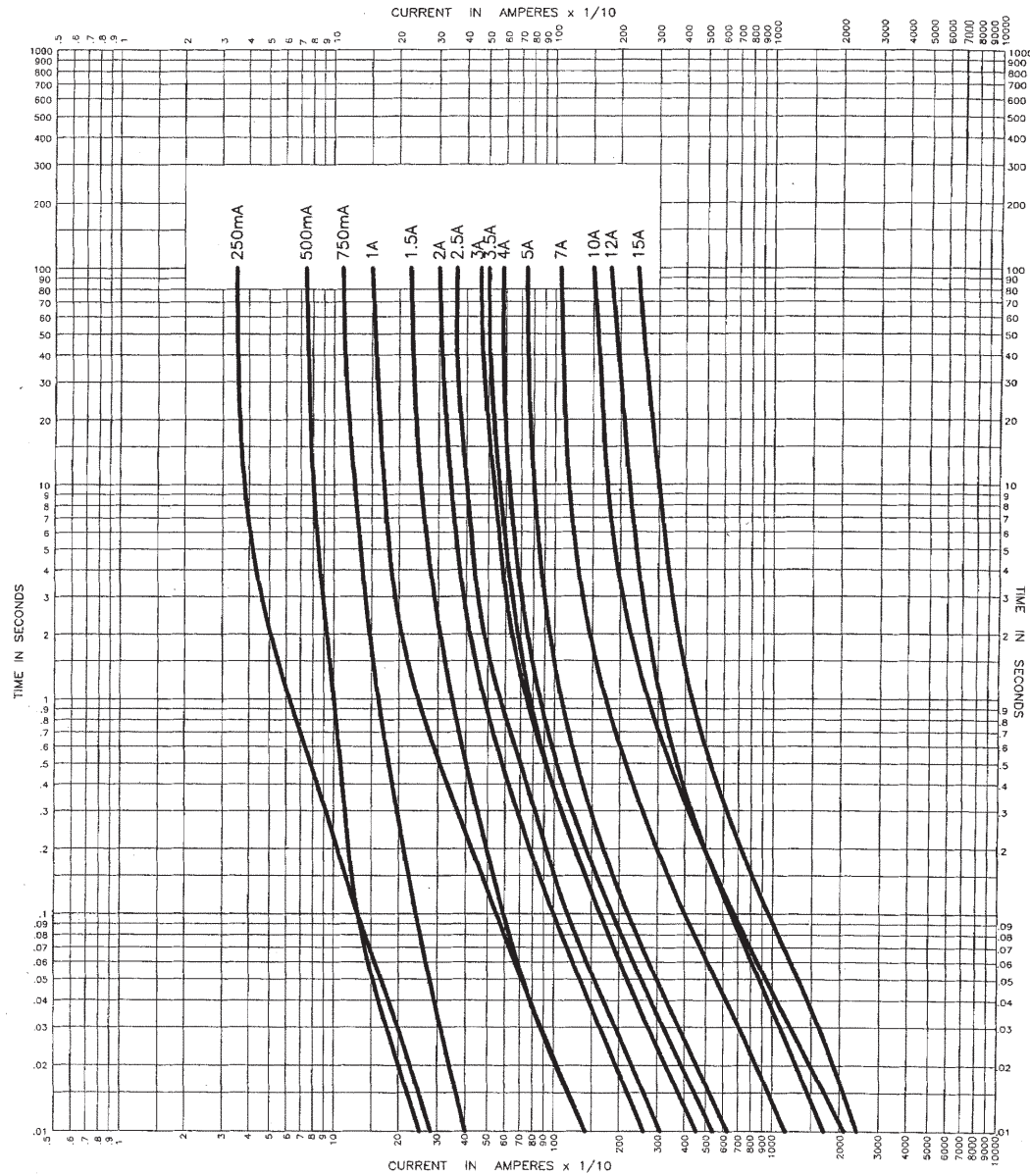

Printed Circuit Board Fuses - Surface Mount

PACKAGING CODE

Packaging Code	Description
TR2	2,500 pieces of fuses on 24mm tape-and-reel on 13 inch (330mm) reel per EIA Standard 481

Description

- The first and most reliable surface mount telecom circuit protector designed to protect against power cross faults and comply with all surge requirements.
- Allows compliance with telecom regulatory standards including Bellcore GR 1089, UL 1950/60950, and FCC part 68. Application circuit testing is recommended.
- Eliminates the need for a current limiting resistor.
- Protects against overcurrent conditions found in telecom Subscriber Line Interface Cards (SLICs), xDSL Modem Applications, Set-Top Boxes, and Consumer Premises Equipment (CPE).
- TCP1.25A tested and confirmed compatible with STMicroelectronics Trisil™ Transient Surge Arrestor (list of part numbers below)

STMicroelectronics Trisil™ P/N's	
SMP100LC-XXX	SMP100MC-XXX

ELECTRICAL CHARACTERISTICS	
% of Amp Rating	Opening Time
100%	4 Hours Minimum
250%	1 Second Minimum
250%	4-10 Seconds Typical
250%*	120 Seconds Maximum
300%	10 Seconds Maximum

* If the device does not open at 250% within 120 seconds, increase current to 300% of amp rating. Device must open in 10 seconds max.

Environmental Data

- Life Test: MIL-STD-202, Method 108A, Test Condition D
- Load Humidity: MIL-STD-202, Method 103B
- Moisture Resistance: MIL-STD-202, Method 106E
- Thermal Shock: MIL-STD-202, Method 107D, air-to-air
- Case Resistance: EIA/IS-722
- Resistance to Dissolution of Metallization: ANSI J-STD-002, Test D
- Mechanical Shock: MIL-STD-202, Method 213B, Test Condition A
- High Frequency Vibration: MIL-STD-202, Method 204D, Test Condition D
- Resistance to Solvents: MIL-STD-202, Method 215A



Dimensions mm/(inches)

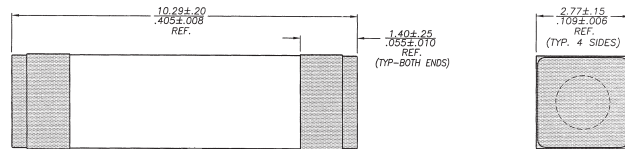

Land Pattern

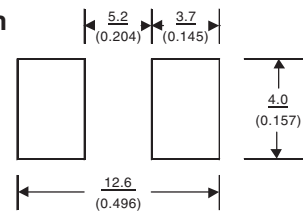

Agency Information

- UL Recognition Card: JDYX2/E19180
- CSA Component Certification Record and Class No.: 053787C000, 1422 30

Ordering

- Specify packaging, product and option code (refer to OC-35) (i.e., TR2/TCP1.25-R)

Soldering Method

- Wave Immersion: 260°C, 10 sec max.
- Infrared: 260°C, 30 sec max.

LIGHTNING SURGE SPECIFICATIONS

Surge Specification	Surge	Repetitions	Waveform (µSec.)	Current (A)	Voltage (V)	Performance Requirement
FCC 47 Part 68	Longitudinal Type A	2	10x160	100 per fuse	1500	Fuse cannot open
FCC 47 Part 68	Metallic Type B	2	10x560	100	800	Fuse cannot open
Bellcore GR-1089-CORE	First Level Lightning	50	10x1000	100	1000	Fuse cannot open
Bellcore GR-1089-CORE	First Level Lightning	50	2x10	500	2500	Fuse cannot open
Surge out		1	10x160	160	N/A	Fuse cannot open
Surge out		1	10x560	115	N/A	Fuse cannot open

ELECTRICAL AND POWER CROSS SPECIFICATIONS

Product Code	Voltage Rating AC	Interrupting Rating*		DC Cold Resistance** (ohms)			Typical Melting I [†] t	Maximum Total Clearing	Typical Voltage Drop‡	Alpha Code Marking	
		250VAC	600VAC	min.	typ.	max.				1st Code	2nd Code
TCP1.25A	250 V	50 A	60 A	0.070	0.090	0.110	22.2 A ² s	100 A ² s	150mV	J	R***

* AC Interrupting Rating (Measured at designated voltage, 100% power factor)

** DC Cold Resistance (Measured at 10% of rated current)

*** On RoHS Compliant Version (-R option)

† Typical Melting I[†]t (Measured with a battery bank at 60V DC, 10x-rated current, time constant of calibrated circuit less than 50 microseconds)

‡ Typical Voltage Drop (Measured at rated current after temperature stabilizes)

Special Investigation

The TCP1.25A is designed to provide overcurrent protection for telecom SLIC, xDSL modem, and set-top box applications regardless of the overvoltage device selected. To provide an easier specification experience, Cooper Bussmann and STMicroelectronics have joined together to provide a special test report confirming the coordination between the TCP1.25A and SMP100MC-270 devices.

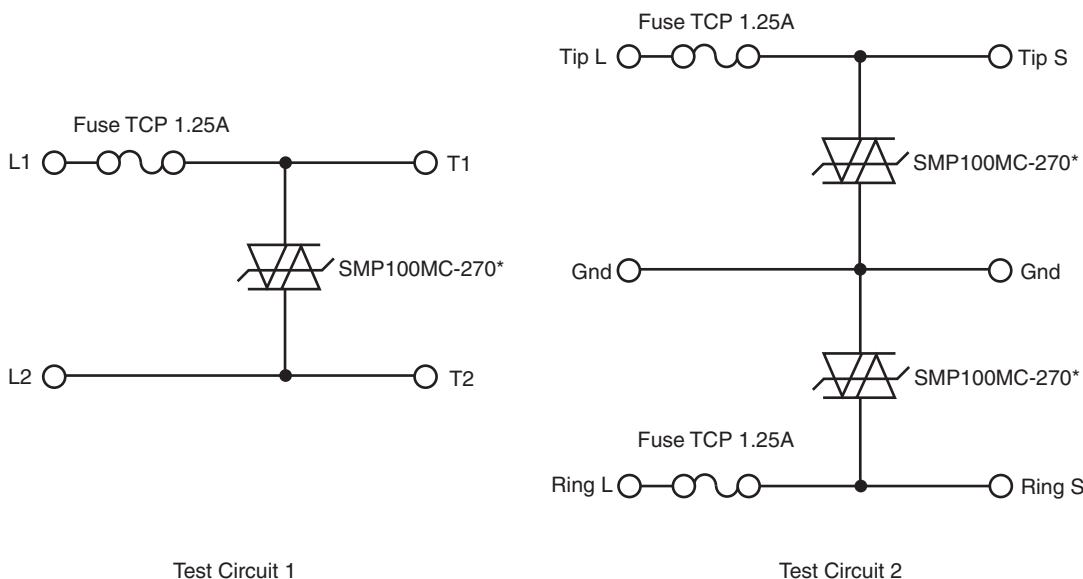
TEST CIRCUITS

Test Circuit 1

Test Circuit 2

* **Note:** or other STMicroelectronics Trisil™ part number listed in table on page 1

TEST PROGRAM

Test	Standard	Results
Lightning Surge Tests		
10/1000µs + and -1kV 100A (25 pulses of each polarity)	Bellcore GR-1089	Passed
2/10µs + and -2.5 and 5kV 500A (10 pulses of each polarity)	Bellcore GR-1089	Passed
10/560µs + and -800V 100A (1 pulse of each polarity)	FCC Part 68	Passed
10/160µs + and -1.5kV 200A (1 pulse of each polarity)	FCC Part 68	Passed
10/700µs + and -1.5kV 37.5A (5 pulses of each polarity)	K20	Passed
Electrical and Power Cross Tests		
600V 3A 1.1s (first level)	Bellcore GR-1089	Passed
277V 25A (second level)	Bellcore GR-1089	Passed
600V 60A 5s(second level)	Bellcore GR-1089	Passed
600V 40A 1.5s	UL 60950	Passed
600V 2.2A 30min	UL 60950	Passed
600V 1A 0.2s (A criteria)	K20	Passed
230V 1.44A/0.77A/0.38A 15min (A criteria)	K20	Passed
230V 23A 15min (A criteria)	K20	Passed

For additional information on STMicroelectronic's Trisil™ Product line, please see www.st.com/protection

Description

- Designed to protect Consumer Premises Equipment from harmful overcurrents.
- Allows compliance with telecom regulatory standards including UL 1950/60950, and FCC part 68. Application circuit testing is recommended.
- Eliminates the need for a current limiting resistor.



ELECTRICAL CHARACTERISTICS	
% of Amp Rating	Opening Time
100%	4 Hours Minimum
250%	1 Second Minimum
250%	4-10 Seconds Typical
250%*	120 Seconds Maximum
300%	10 Seconds Maximum

* If the device does not open at 250% within 120 seconds, increase current to 300% of amp rating. Device must open in 10 seconds max.

Agency Information

- UL Recognition Card: JDYX2/E19180
- CSA Component Certification Record and Class No.: 053787C000, 1422 30

Environmental Data

- Life Test: MIL-STD-202, Method 108A, Test Condition D
- Load Humidity: MIL-STD-202, Method 103B
- Moisture Resistance: MIL-STD-202, Method 106E
- Thermal Shock: MIL-STD-202, Method 107D, air-to-air
- Case Resistance: EIA/IS-722
- Resistance to Dissolution of Metallization: ANSI J-STD-002, Test D
- Mechanical Shock: MIL-STD-202, Method 213B, Test Condition A
- High Frequency Vibration: MIL-STD-202, Method 204D, Test Condition D
- Resistance to Solvents: MIL-STD-202, Method 215A

Dimensions mm/(inches)

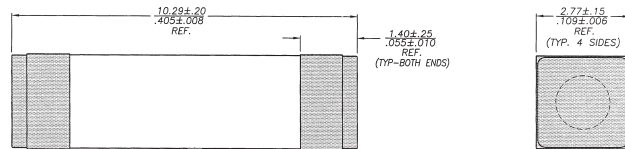

Land Pattern

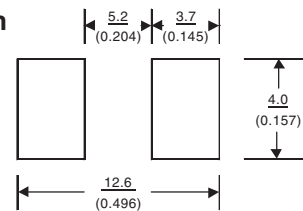

Ordering

- Specify packaging, product and option code (i.e., TR2/TCP500-R)

Soldering Method

- Wave Immersion: 260°C, 10 sec max.
- Infrared: 260°C, 30 sec max.

LIGHTNING SURGE SPECIFICATIONS

Surge Specification	Surge	Repetitions	Waveform (µSec.)	Current (A)	Voltage (V)	Performance Requirement
TCP 500mA tested						
FCC 47 Part 68	Longitudinal Type B	2	5x320	37.5	N/A	Fuse cannot open
FCC 47 Part 68	Metallic Type A	2	10x560	100	800	Fuse must open safely
Surge out		25	10x160	65	N/A	Fuse cannot open
TCP2A tested						
FCC 47 Part 68	Longitudinal Type A	2	10x160	100 per fuse	1500	Fuse cannot open
FCC 47 Part 68	Metallic Type B	2	10x560	100	800	Fuse cannot open
Bellcore GR-1089-CORE	First Level Lightning	50	10x1000	100	1000	Fuse cannot open
Bellcore GR-1089-CORE	First Level Lightning	50	2x10	500	2500	Fuse cannot open
Surge out		1	10x160	160	N/A	Fuse cannot open
Surge out		1	10x560	115	N/A	Fuse cannot open

ELECTRICAL AND POWER CROSS SPECIFICATIONS

Product Code	Voltage Rating AC	Interrupting Rating*		DC Cold Resistance** (ohms)			Typical Melting I ^{††}	Maximum Total Clearing	Typical Voltage Drop‡	Alpha Code Marking	
		250VAC	600VAC	min.	typ.	max.				1st Code	2nd Code
TCP500mA	250 V	50 A	40 A	0.420	0.530	0.640	1.3 A ² s	100 A ² s	471mV	F	R***
TCP2A	250 V	50 A	60 A	0.050	0.075	0.100	30 A ² s	100 A ² s	205mV	N	

* AC Interrupting Rating (Measured at designated voltage, 100% power factor)

** DC Cold Resistance (Measured at 10% of rated current)

*** On RoHS Compliant Version (-R option)

† Typical Melting I^{††} (Measured with a battery bank at 60V DC, 10x-rated current, time constant of calibrated circuit less than 50 microseconds)

‡ Typical Voltage Drop (Measured at rated current after temperature stabilizes)

TIME CURRENT CURVE

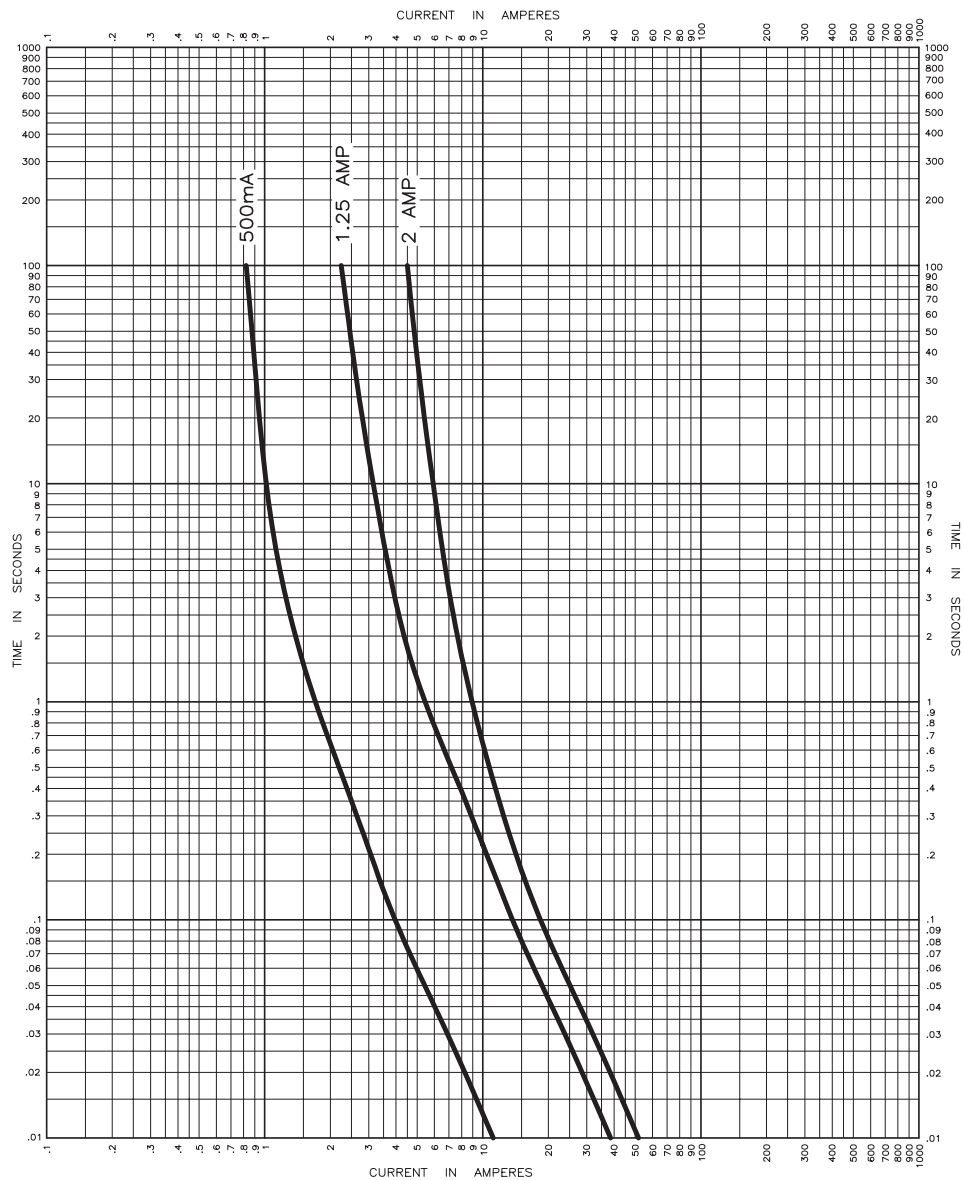

Printed Circuit Board Fuses - Surface Mount

PACKAGING CODE

Packaging Code	Description
TR2	2,500 pieces of fuses on 24mm tape-and-reel on 13 inch (330mm) reel per EIA Standard 481, 8mm pitch

OPTION CODE

Option Code	Description
-R	RoHS Compliant Version (Sn plating w/ Ni barrier)

Subminiature Microtron® Fuses

MCRW Series, Fast Acting, Wire-in-Air

Description

- Axial Leaded Fast Acting Thru-Hole Fuse
- Tin-lead Plated Copper Lead Wires
- High Temperature Epoxy Plastic Body, UL 94 VO
- Low resistance values

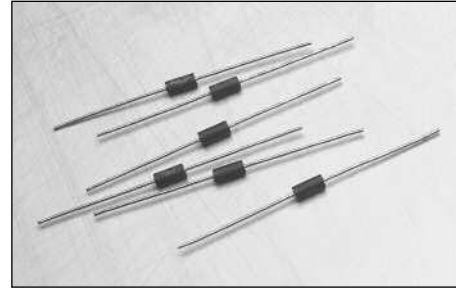

ELECTRICAL CHARACTERISTICS	
% of Amp Rating	Opening Time
100%	4 hours minimum
200%	5 seconds maximum

Agency Information

- UL Recognition Guide & File numbers: JDYX2 & E195337.
- CSA Certification Record No: LR 701159 & Class No: 1422 30 and 1422 01.

Environmental Data

- Shock Resistance: MIL-STD-202, Method 213, Test Condition 1 (Sawtooth)
- Vibration Resistance: MIL-STD-202, Method 201 (10-55 Hz x 3 axis/ no load)
- Moisture Resistance: MIL-STD-202F, Method 106
- Soldering Heat Resistance: 260°C, 10 seconds per IEC 68-2-20
- Salt Spray: MIL-STD-202, Method 101, Test Condition B (48 Hours)

Ordering

- Specify packaging and product code (i.e., TR1/MCRW100mA)

Soldering Method

- Heat Resistance: 260°C, 10 sec per IEC 68-2-20

Dimensions ^{mm/(inches)}

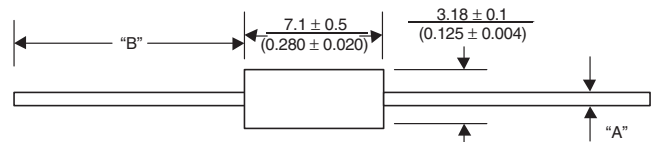

Amperage	"A" Diameter	Packaging Code	"B" Length
100mA - 7A	0.025"	BK1	1.5"
10A - 15A	0.032"	TR1	1.13"

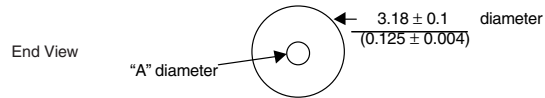

Construction

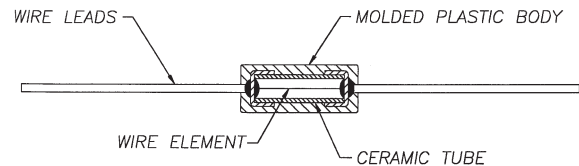

SPECIFICATIONS

Product Code	Voltage Rating AC/DC	Interrupting Rating*		Resistance (ohms)** Typ.	Typical Melt I ² t†	Typical Voltage Drop (V)‡
		AC	DC			
MCRW100mA	125 V	50 A	300 A	15.5	0.0006	0.68
MCRW125mA	125 V	50 A	300 A	2.2	0.0009	0.61
MCRW150mA	125 V	50 A	300 A	1.6	0.0015	0.54
MCRW200mA	125 V	50 A	300 A	1.2	0.002	0.48
MCRW250mA	125 V	50 A	300 A	0.85	0.004	0.43
MCRW300mA	125 V	50 A	300 A	0.62	0.008	0.39
MCRW375mA	125 V	50 A	300 A	0.49	0.012	0.35
MCRW500mA	125 V	50 A	300 A	0.33	0.023	0.31
MCRW750mA	125 V	50 A	300 A	0.19	0.056	0.25
MCRW1A	125 V	50 A	300 A	0.13	0.10	0.22
MCRW1.5A	125 V	50 A	300 A	0.07	0.25	0.18
MCRW2A	125 V	50 A	300 A	0.054	0.27	0.24
MCRW2.5A	125 V	50 A	300 A	0.041	0.50	0.22
MCRW3A	125 V	50 A	300 A	0.031	0.9	0.20
MCRW4A	125 V	50 A	300 A	0.023	1.6	0.19
MCRW5A	125 V	50 A	300 A	0.018	3	0.17
MCRW7A	125 V	50 A	300 A	0.012	7	0.15
MCRW10A	125 V	50 A	300 A	0.007	21	0.098
MCRW12A	125 V	50 A	300 A	0.006	35	0.093
MCRW15A	125 V	50 A	300 A	0.004	63	0.088

* AC Interrupting Rating (Measured at designated voltage, 100%) DC Interrupting Rating (Measured at designated voltage, rise time of less than 50 microseconds, battery source)

** DC Cold Resistance (Measured at 10% of rated current)

† Typical Melting I²t (Measured with a battery bank at rated DC voltage, 10x-rated current, rise time of calibrated circuit less than 50 microseconds)

‡ Typical Voltage Drop (Measured at rated current after temperature stabilizes)

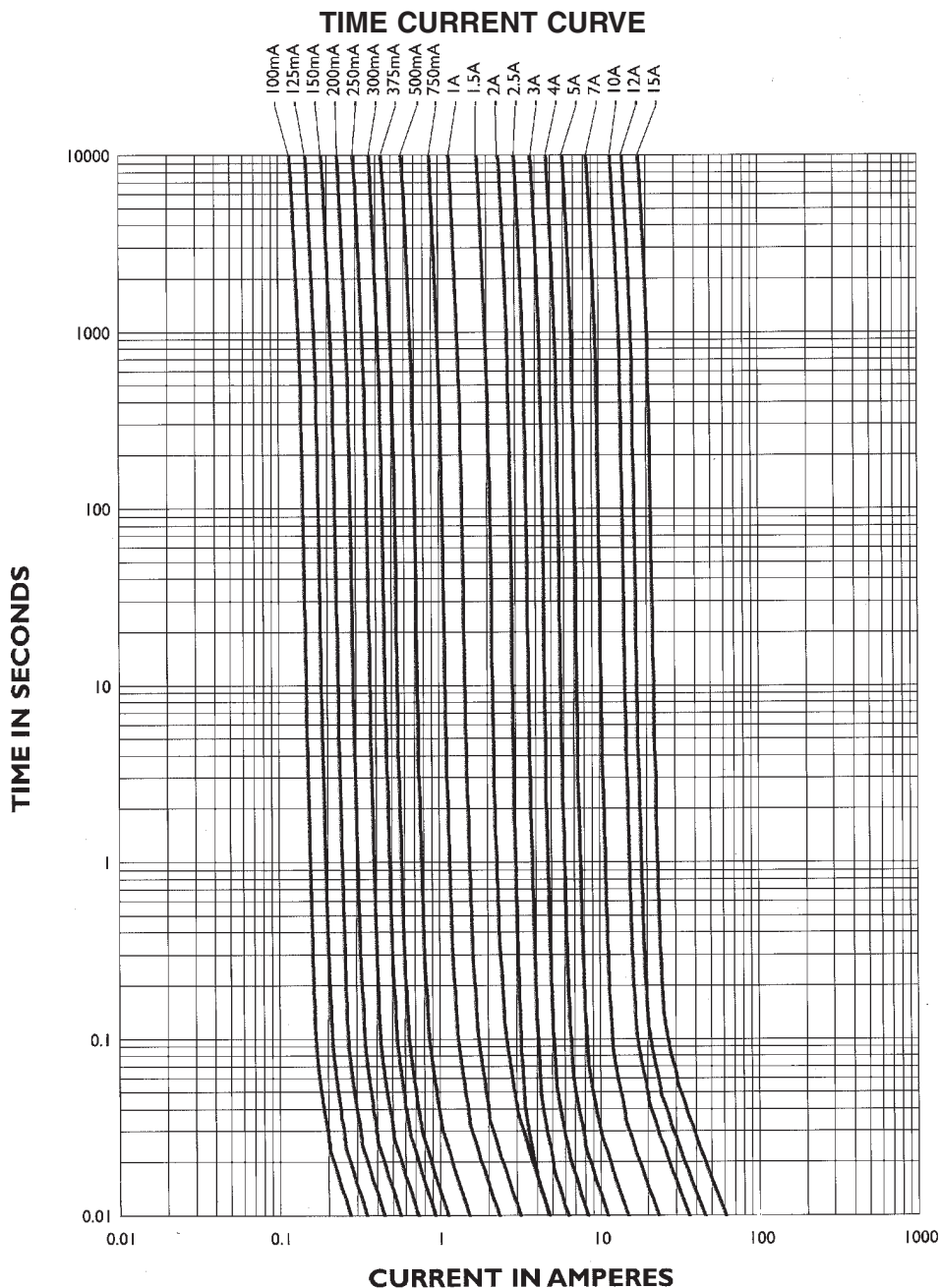

PACKAGING CODE	
Packaging Code	Description
BK1	1,000 pieces in bulk
TR1	2,500 pieces on tape-and-reel per EIA-296-E @ 5 mm pitch and 52.4mm inside tape spacing

Subminiature Microtron® Fuses

MCRS Series, Slow Blow, Wire-in-Air

Description

- Axial Leaded Slow Blow Thru-Hole Fuse
- Tin-lead Plated Copper Lead Wires
- High Temperature Epoxy Plastic Body, UL 94 VO

ELECTRICAL CHARACTERISTICS	
% of Amp Rating	Opening Time
100%	4 hours minimum
200%	30 seconds maximum

Agency Information

- UL Recognition Guide & File numbers: JDYX2 & E195337.
- CSA Certification Record No: LR 701159 & Class No: 1422 30 and 1422 01.

Environmental Data

- Shock Resistance: MIL-STD-202, Method 213, Test Condition 1 (Sawtooth)
- Vibration Resistance: MIL-STD-202, Method 201 (10-55 Hz x 3 axis/ no load)
- Moisture Resistance: MIL-STD-202F, Method 106
- Soldering Heat Resistance: 260°C, 10 seconds per IEC 68-2-20
- Salt Spray: MIL-STD-202, Method 101, Test Condition B (48 Hours)

Ordering

- Specify packaging and product code (i.e., TR1/MCRS250mA)

Soldering Method

- Heat Resistance: 260°C, 10 sec per IEC 68-2-20

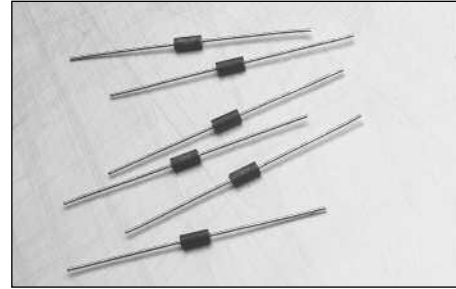

Dimensions mm/(inches)

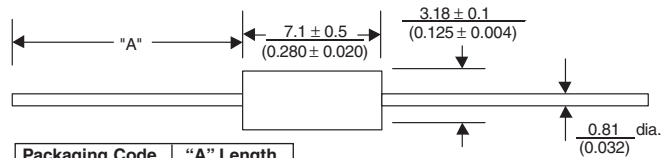

Packaging Code	"A" Length
BK1	1.5"
TR1	1.13"

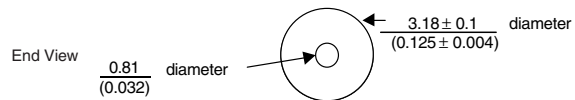

Construction

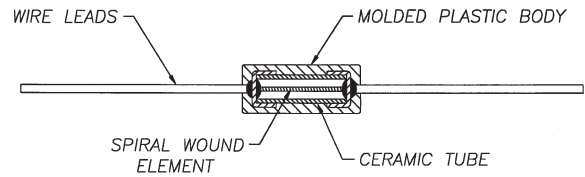

SPECIFICATIONS

Product Code	Voltage Rating AC/DC	Interrupting Rating*		Resistance (ohms)** Typ.	Typical Melt I ² t†	Typical Voltage Drop (V)‡
		AC	DC			
MCRS250mA	125 V	50 A	300 A	3.20	0.042	2.20
MCRS300mA	125 V	50 A	300 A	2.57	0.056	2.02
MCRS375mA	125 V	50 A	300 A	1.66	0.101	1.69
MCRS500mA	125 V	50 A	300 A	1.07	0.18	1.42
MCRS750mA	125 V	50 A	300 A	0.55	0.44	1.09
MCRS1A	125 V	50 A	300 A	0.36	0.78	0.91
MCRS1.25A	125 V	50 A	300 A	0.23	1.41	0.77
MCRS1.5A	125 V	50 A	300 A	0.18	1.9	0.7
MCRS2A	125 V	50 A	300 A	0.12	3.4	0.59
MCRS2.5A	125 V	50 A	300 A	0.08	6.1	0.5
MCRS3A	125 V	50 A	300 A	0.06	8.1	0.45
MCRS4A	125 V	50 A	300 A	0.04	15	0.38
MCRS5A	125 V	50 A	300 A	0.02	35	0.29
MCRS7A	125 V	50 A	300 A	0.01	63	0.25

* AC Interrupting Rating (Measured at designated voltage, 100%) DC Interrupting Rating (Measured at designated voltage, rise time of less than 50 microseconds, battery source)

** DC Cold Resistance (Measured at 10% of rated current)

† Typical Melting I²t (Measured with a battery bank at rated DC voltage, 10x-rated current, rise time of calibrated circuit less than 50 microseconds)

‡ Typical Voltage Drop (Measured at rated current after temperature stabilizes)

TIME CURRENT CURVE

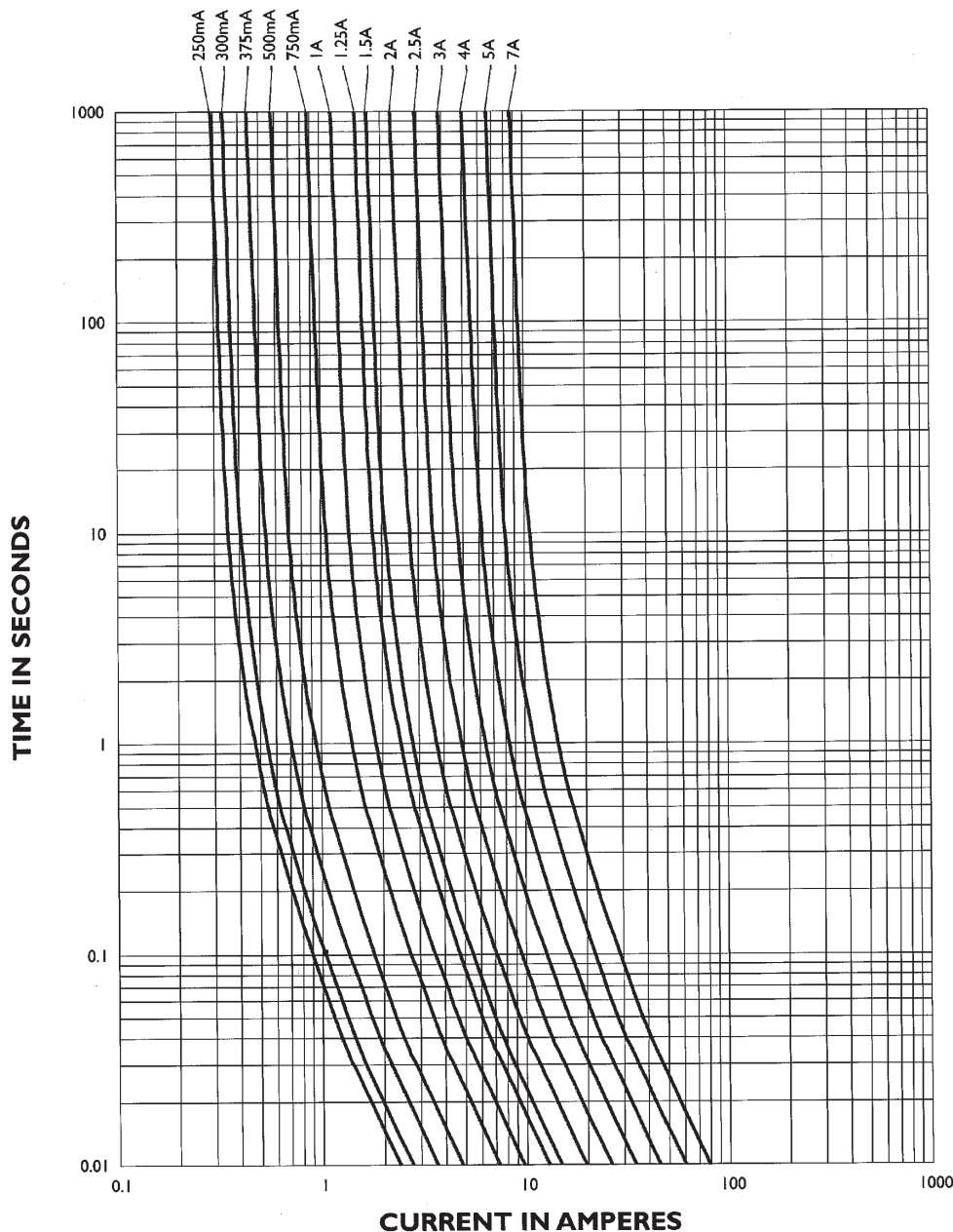

PACKAGING CODE	
Packaging Code	Description
BK1	1,000 pieces in bulk
TR1	2,500 pieces on tape-and-reel per EIA-296-E @ 5 mm pitch and 52.4mm inside tape spacing

Description

- Radial Leaded Fast Acting Thru-Hole Fuse
- Ideal for high voltage DC applications
- Board washable
- Optional mounting socket available (PCS)
- Available in different lead configurations

AC TIME-CURRENT CHARACTERISTICS	
% of Amp Rating	Opening Time
100%	4 hours minimum
200%	10 second maximum

Agency Information

- UL Recognized: E19180
- CSA: 42731

Ordering

- Specify packaging, product, and option code (i.e., BK/PCB-1/2-R)

DC Application

The PC-Tron subminiature fuse is UL Recognized for DC supplementary overcurrent protection to provide individual protection for components or internal circuits in equipment. Suitability for a specific application is dependent on time constants and capacitance values. It is the responsibility of the customer to evaluate the information provided for applicability to their particular application.

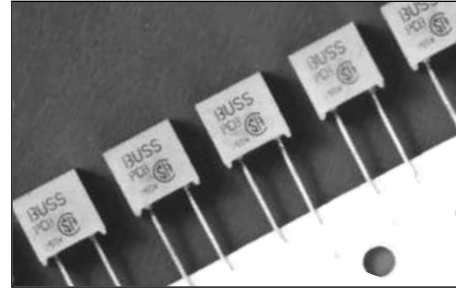

Dimensions mm/(inches)

Dimensional Data: All tolerances $\pm .005"$
 $\pm .13 \text{ mm}$

Mounting Socket (RoHS compliant)

- Available as option. Specify catalog number BK/PCS (100-in) and short fuse lead length — PCC or PCE

Socket (PCS)

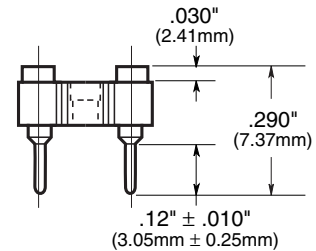
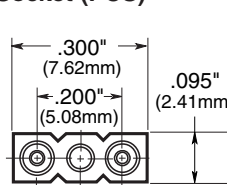

Printed Circuit Board Fuses - Axial and Radial Leaded

SPECIFICATIONS

Product Code / Amp Rating	Lead Length	Voltage Rating AC	AC	Voltage Rating DC	DC Interrupting	
			Interrupting		Min.	Max.
PCB - 1/2, 3/4, 1, 1-1/2, 2, 2-1/2	Full - 0.750" (straight)	250V	50A @ 250V 10kA @ 125V	450V	300	5900A
PCB - 3	Full - 0.750" (straight)	250V	50A @ 250V	350V	300	4400A
PCC - 1/2, 3/4, 1, 1-1/2, 2, 2-1/2	Short 0.100" (straight)	250V	50A @ 250V 10kA @ 125V	450V	300	5900A
PCC - 3	Short 0.100" (straight)	250V	50A @ 250V 10kA @ 125V	350V	300	4400A
PCD - 5	Full - 0.750" (straight)	125V	10kA @ 125V	250V	300	4200A
PCE - 5	Short 0.100" (straight)	125V	10kA @ 125V	250V	300	4200A
PCF - 1/2, 3/4, 1, 1-1/2, 2, 2-1/2	0.475"	250V	50A @ 250V 10kA @ 125V	450V	300	5900A
PCF - 3	0.475"	250V	50A @ 250V 10kA @ 125V	350V	300	4400A
PCG - 5	0.475"	125V	10kA @ 125V	250V	300	4200A
PCH - 1/2, 3/4, 1, 1-1/2, 2, 2-1/2	0.125"	250V	50A @ 250V 10kA @ 125V	450V	300	5900A
PCH - 3	0.125"	250V	50A @ 250V 10kA @ 125V	350V	300	4400A
PCI - 5	0.125"	125V	10kA @ 125V	250V	300	4200A

Device designed to carry rated current for four hours minimum. An operating current of 80% or less of rated current is recommended, with further derating required at elevated ambient temperatures.

Dimensional Data: All tolerances $\pm .005"$
 $\pm .13 \text{ mm}$

Standard Fuse (PCB, PCD)

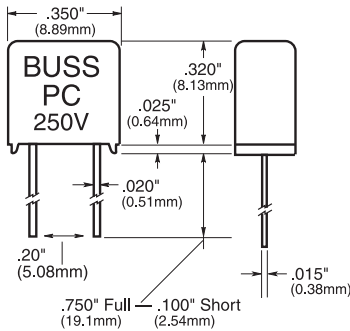

Dimensional Data (PCH, PCI)

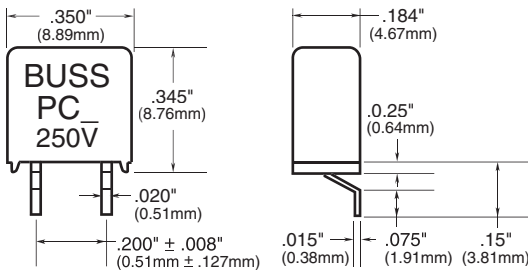

Dimensional Data (PCF, PCG)

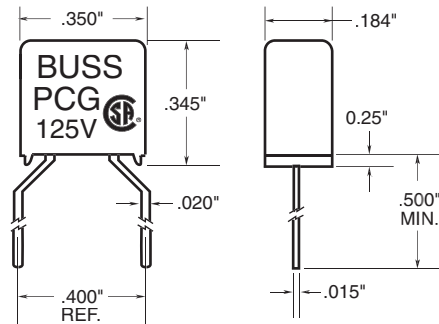

Time-Current Characteristic Curves—Average Melt

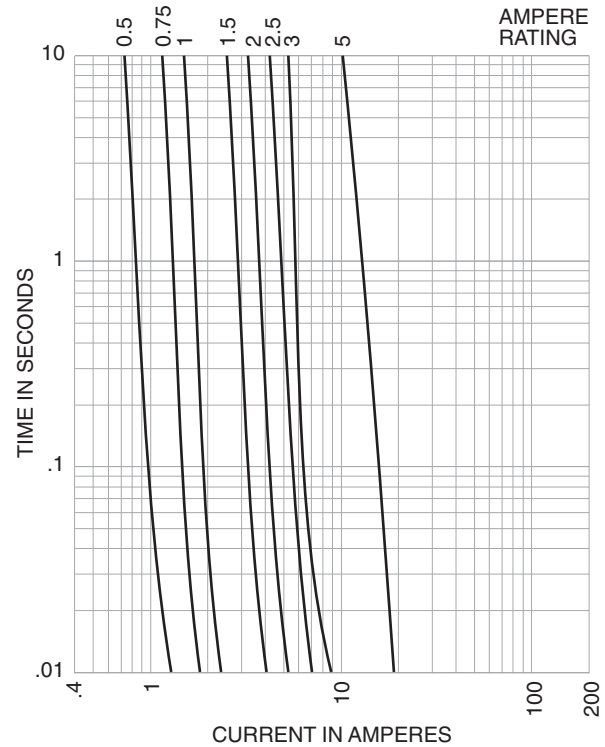

Max. Total Clearing I²t (Amps² Sec.)

Amp Rating	Volts AC			
	125 Volts	1,000A	10,000A	250 Volts 35A & 50A
1/2A	0.006	0.006	0.006	0.006
3/4A	0.016	0.016	0.016	0.016
1A	0.020	0.020	0.020	0.020
1-1/2A	0.090	0.090	0.090	0.090
2A	0.200	0.200	0.200	0.200
2-1/2A	0.300	0.300	0.300	0.300
3A	0.750	0.750	0.750	0.750
5A	5.0	5.0	5.0	—

Note—Power Factor > .90.

PACKAGING CODE

Packaging Code	Description
Blank	5 pieces of fuses
BK	100 pieces of fuses in a carton
TR*	500 pieces of fuses on tape and Reel

* Only for PCB and PCD

OPTION CODE

Option Code	Description
-R	RoHS Compliant Version

Subminiature Fuses

SR-5 Series, Time Lag

Description

- Radial Leaded Time Lag Thru-Hole Fuse
- Designed to IEC 60127-3, Sheet 4
- Internationally accepted for primary and secondary overcurrent protection
- Place directly into PCB or plug into BK/PCS holder
- High inrush withstand capability
- Compatible with leaded and lead-free reflow and wave solder
- Base/Cap is Nylon #66, UL 94V0
- Pins are Tin Plated Copper

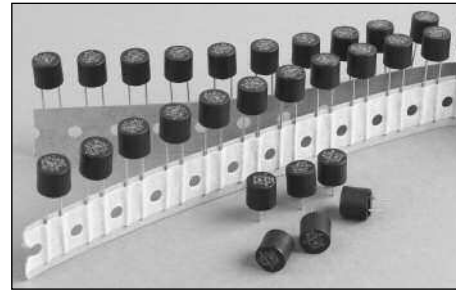

ELECTRICAL CHARACTERISTICS										
Rated Current	1.5 In		2.1 In		2.75 In		4 In		10 In	
	min	max	min	max	min	max	min	max	min	max
400mA-6.3A	1 hr	2 min	400 ms	10 sec	150 ms	3 sec	20 ms	150 ms		

Agency Information

- UL Recognition: E146895 (400mA thru 6.3A)
- CSA: LR98127 (400mA thru 5A)
- VDE: 122052 (500mA thru 4A, 6.3A)
- SEMKO: 0035176 (500mA thru 4A)
- CCC 2003010207072514 (500mA thru 4A)
- METI: 32-1966 (500mA thru 5A)
- EK: KTL SA05004 (500mA thru 4A)
- Remaining 5-6.3A Approvals Pending

Specifications

- Solderability: EIA-186-9E Method 9
- High Frequency Vibration: MIL-STD-202F, Method 201A
- Operating Temperature: -40°C to +125°C
- Soldering Heat Resistance: 260°C, 10S (IEC 60068-2-20)

Ordering

- Specify product and packaging code (i.e., SR-5-1A-AP)

Dimensions mm/(inches)

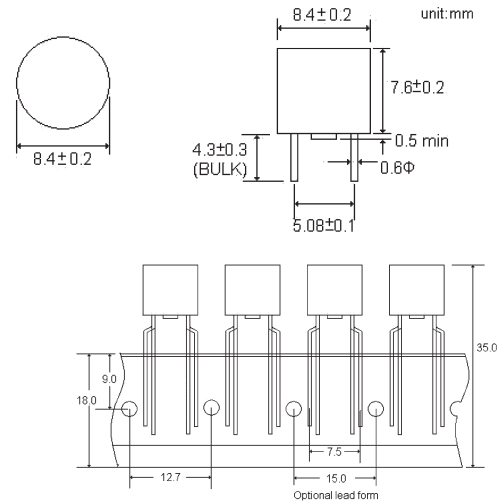

Printed Circuit Board Fuses - Axial and Radial Leaded

SPECIFICATIONS

Product Code	Voltage Rating AC	Interrupting Rating @ Rated Voltage	Typical DC Cold Resistance (ohms)	Typical Melting I ² t (A ² s) at 1ms	Maximum Power Dissipation (mW)
SR-5-500mA	250V	35A	0.270	2	310
SR-5-630mA	250V	35A	0.175	3.5	360
SR-5-800mA	250V	35A	0.125	6.5	430
SR-5-1A	250V	35A	0.083	9	500
SR-5-1.25A	250V	35A	0.061	13	600
SR-5-1.6A	250V	35A	0.047	24	730
SR-5-2A	250V	35A	0.031	30	870
SR-5-2.5A	250V	35A	0.028	45	1000
SR-5-3.15A	250V	35A	0.023	57	1200
SR-5-4A	250V	40A	0.015	80	1400
*SR-5-5A	250V	50A	0.011	120	1800
*SR-5-6.3A	250V	63A	0.009	140	2000

* Conducting Path min. 0.2mm²

TIME CURRENT CURVE

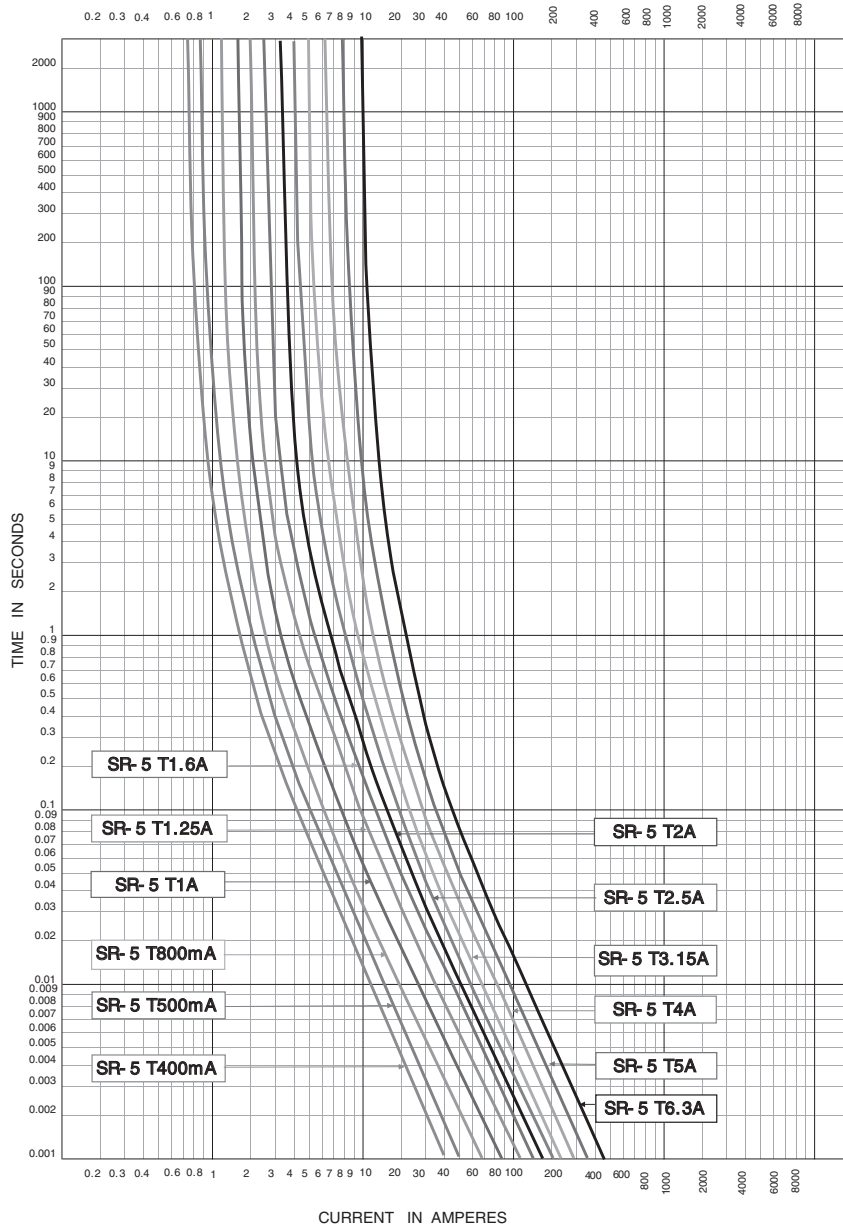

PACKAGING CODE	
Packaging Code	Description
-AP	Ammo-pack taped 1,000 per box
-BK	In bulk 200 per bag

Subminiature Fuses

SS-5 Series, Time Lag

Description

- Radial Leaded Time Lag Thru-Hole Fuse
- Rectangular shape with reduced foot print
- Designed to IEC 60127-3, Sheet 4
- Internationally accepted for primary and secondary overcurrent protection
- Place directly into PCB or plug into BK/PCS holder
- High inrush withstand capability
- Compatible with leaded and lead-free reflow and wave solder
- Base/Cap is Nylon #66, UL 94V0
- Pins are Tin Plated Copper

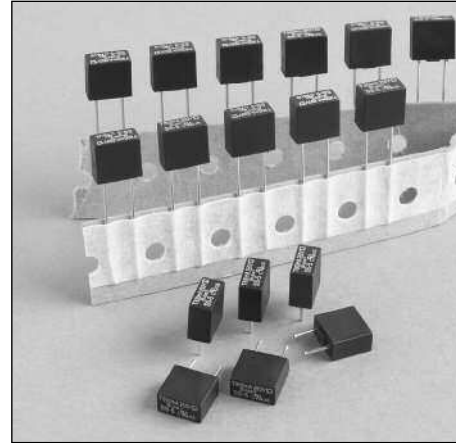

ELECTRICAL CHARACTERISTICS										
Rated Current	1.5 In		2.1 In		2.75 In		4 In		10 In	
	min	max	min	max	min	max	min	max	min	max
400mA-6.3A	1 hr	2 min	400 ms	10 sec	150 ms	3 sec	20 ms	150 ms		

Agency Information

- UL Recognition: E146895 (400mA thru 6.3A)
- CSA: LR98127 (400mA thru 5A)
- VDE: 122052 (500mA thru 4A, 6.3A)
- SEMKO: 603891 (630mA thru 4A)
- CQC 05012014933 (630mA thru 4A)
- METI: 32-1966 (500mA thru 5A)
- Remaining 5-6.3A Approvals Pending

Specifications

- Solderability: EIA-186-9E Method 9
- High Frequency Vibration: MIL-STD-202F, Method 201A
- Operating Temperature: -40°C to +125°C
- Soldering Heat Resistance: 260°C, 10S (IEC 60068-2-20)

Ordering

- Specify product and packaging code (i.e., SS-5-1A-AP)

Dimensions mm/(inches)

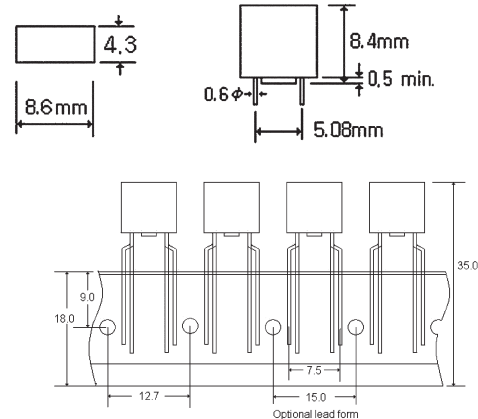

SPECIFICATIONS

Product Code	Voltage Rating AC	Interrupting Rating @ Rated Voltage	Typical DC Cold Resistance (ohms)	Typical Melting I ^t (A ² s) at 1ms	Maximum Power Dissipation (mW)
SS-5-500mA	250V	35A	0.270	2	310
SS-5-630mA	250V	35A	0.175	3.5	360
SS-5-800mA	250V	35A	0.125	6.5	430
SS-5-1A	250V	35A	0.083	9	500
SS-5-1.25A	250V	35A	0.061	13	600
SS-5-1.6A	250V	35A	0.047	24	730
SS-5-2A	250V	35A	0.031	30	870
SS-5-2.5A	250V	35A	0.028	45	1000
SS-5-3.15A	250V	35A	0.023	57	1200
SS-5-4A	250V	40A	0.015	80	1400
*SS-5-5A	250V	50A	0.011	120	1800
*SS-5-6.3A	250V	63A	0.009	140	2000

* Conducting Path min. 0.2mm²

TIME CURRENT CURVE

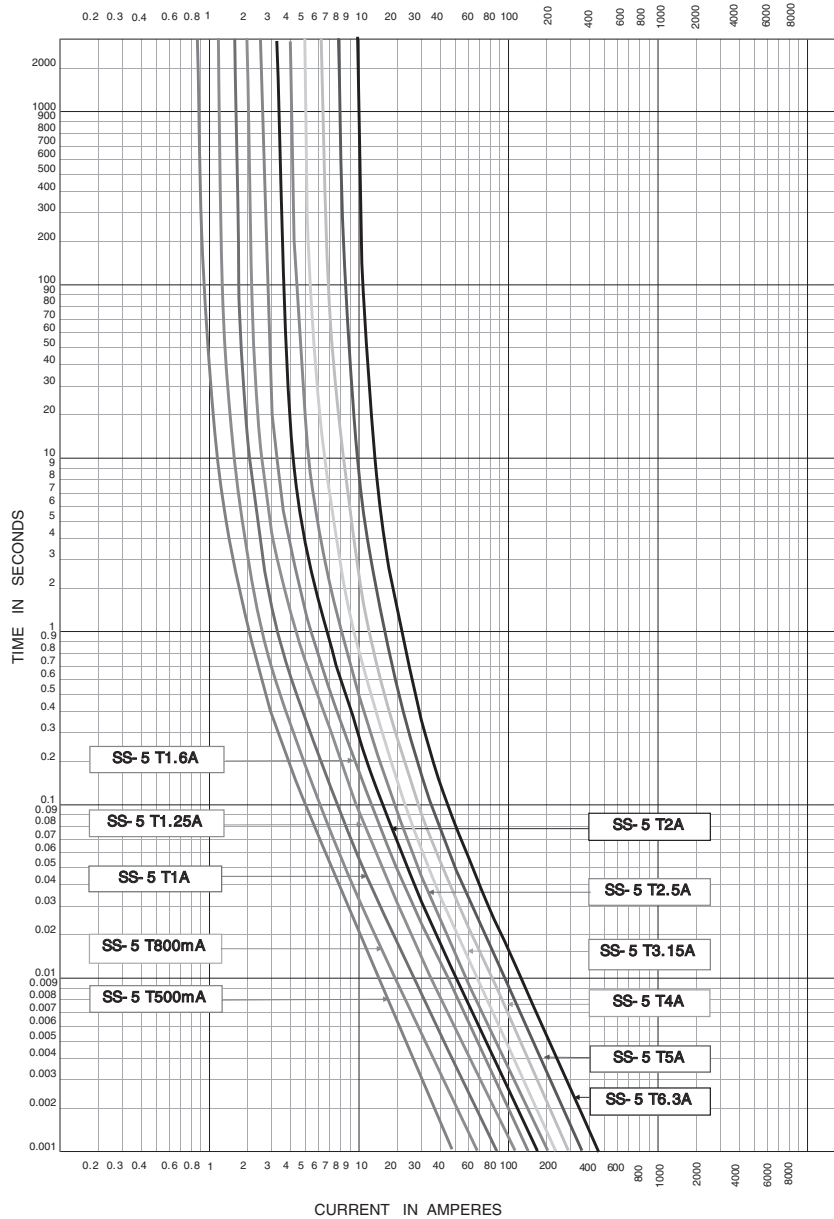

PACKAGING CODE	
Packaging Code	Description
-AP	Ammo-pack taped 1,000 per box
-BK	In bulk 200 per bag

Subminiature Fuses

SR-5F Series, Fast Acting

Description

- Radial Leaded Fast Acting Thru-Hole Fuse
- Designed to UL 248-14
- Accepted for primary and secondary overcurrent protection
- Place directly into PCB or plug into BK/PCS holder
- Compatible with leaded and lead-free reflow and wave solder
- Base/Cap is Nylon #66, UL 94V0
- Pins are Tin Plated Copper

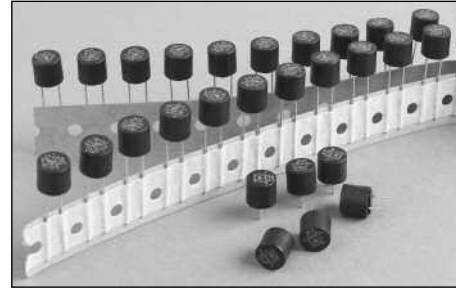

ELECTRICAL CHARACTERISTICS			
Rated Current	1 In min	1.5 In max	2 In max
400mA-10A	1hr	10 min	2 min

Agency Information

- UL Listed: E146895 (400mA thru 10A)
- CSA: LR98127 (400mA thru 10A)

Specifications

- Solderability: EIA-186-9E Method 9
- High Frequency Vibration: MIL-STD-202F, Method 201A
- Operating Temperature: -40°C to +125°C
- Soldering Heat Resistance: 260°C, 10S (IEC 60068-2-20)

Ordering

- Specify product and packaging code (i.e., SR-5F-1A-AP)

Dimensions mm/(inches)

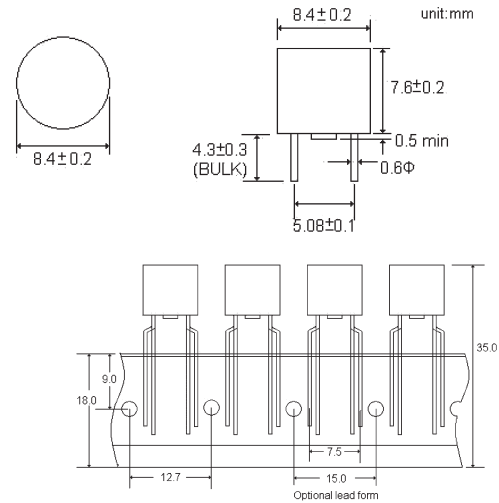

SPECIFICATIONS				
Product Code	Voltage Rating AC	Interrupting Rating @ Rated Voltage	Typical DC Cold Resistance (ohms)	Typical Melting I ² t (A ² s) at 1ms
SR-5F-800mA	250V	50A	210	2.7
SR-5F-1A	250V	50A	120	4.9
SR-5F-1.6A	250V	50A	73	8.0
SR-5F-2A	250V	50A	50	12.1
SR-5F-2.5A	250V	50A	40	16.8
SR-5F-3.15A	250V	50A	32	32.4
SR-5F-4A	250V	50A	25	48.4
*SR-5F-5A	250V	50A	17	75.0
*SR-5F-6.3A	125V	50A	14	108
*SR-5F-7A	125V	50A	11	160
*SR-5F-8A	125V	50A	9	190
*SR-5F-10A	125V	50A	7	270

* Conducting Path min. 0.2mm²

TIME CURRENT CURVE

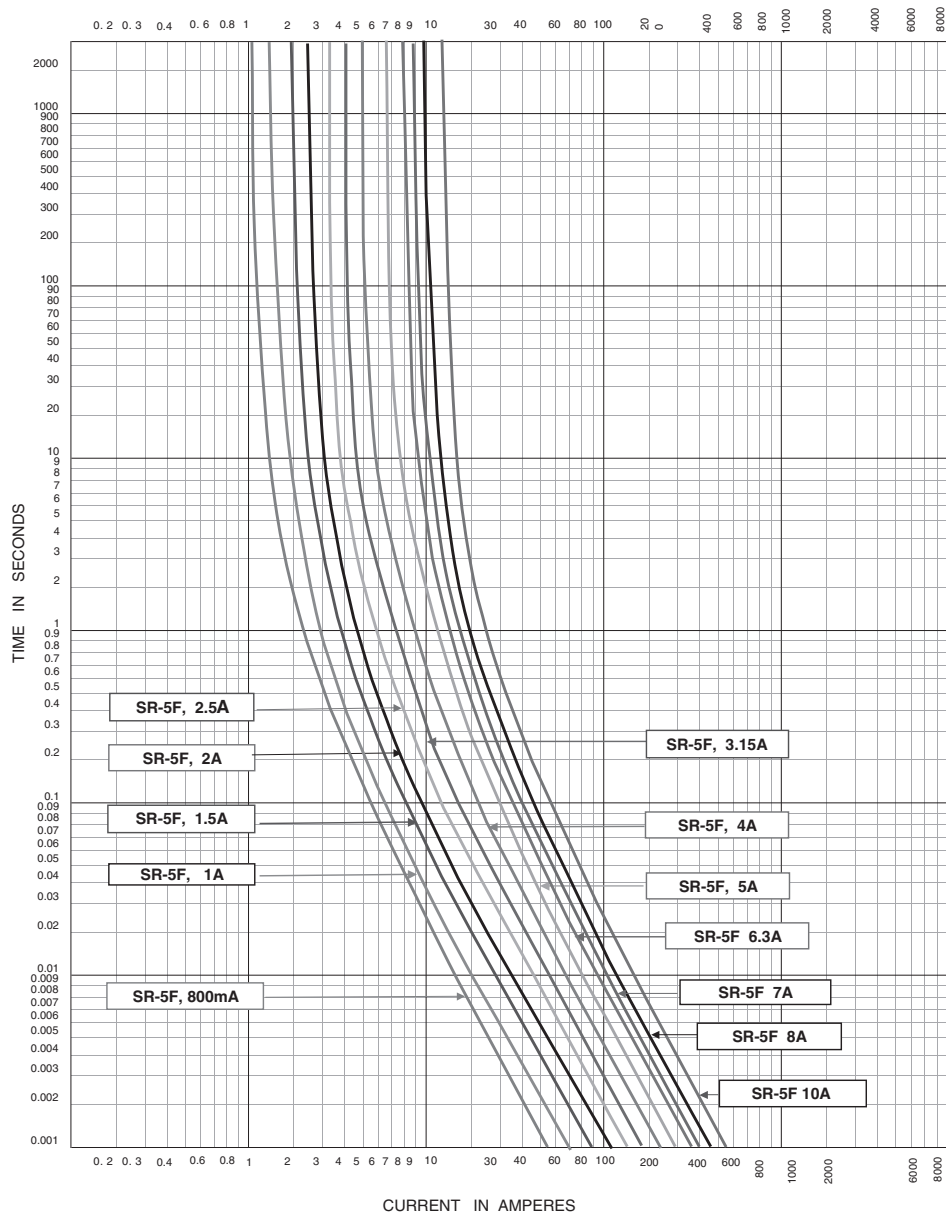

PACKAGING CODE	
Packaging Code	Description
-AP	Ammo-pack taped 1,000 per box
-BK	In bulk 200 per bag

Subminiature Fuses SS-5F Series, Fast Acting

Description

- Radial Leaded Fast Acting Thru-Hole Fuse
- Rectangular shape with reduced foot print
- Designed to UL 248-14
- Accepted for primary and secondary overcurrent protection
- Place directly into PCB or plug into BK/PCS holder
- Compatible with leaded and lead-free reflow and wave solder
- Base/Cap is Nylon #66, UL 94V0
- Pins are Tin Plated Copper

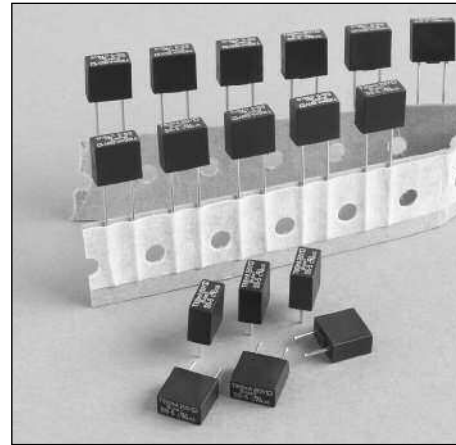

ELECTRICAL CHARACTERISTICS			
Rated Current	1 In min	1.5 In max	2 In max
400mA-10A	1hr	10 min	2 min

Agency Information

- UL Listed: E146895 (400mA thru 10A)
- CSA: LR98127 (400mA thru 10A)

Specifications

- Solderability: EIA-186-9E Method 9
- High Frequency Vibration: MIL-STD-202F, Method 201A
- Operating Temperature: -40°C to +125°C
- Soldering Heat Resistance: 260°C, 10S (IEC 60068-2-20)

Ordering

- Specify product and packaging code (i.e., SS-5F-1A-AP)

Dimensions mm/(inches)

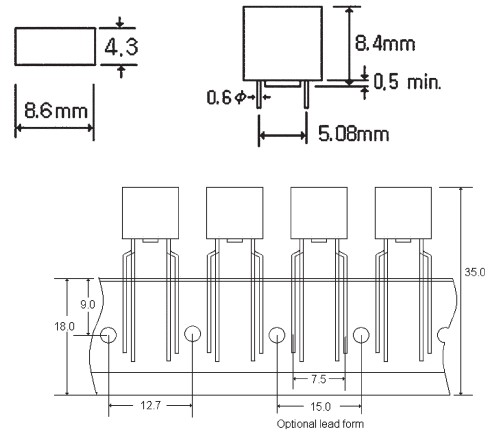

Printed Circuit Board Fuses - Axial and Radial Leaded

SPECIFICATIONS				
Product Code	Voltage Rating AC	Interrupting Rating @ Rated Voltage	Typical DC Cold Resistance (ohms)	Typical Melting I ² t (A ² s) at 1ms
SS-5F-800mA	250V	50A	210	2.7
SS-5F-1A	250V	50A	120	4.9
SS-5F-1.6A	250V	50A	73	8.0
SS-5F-2A	250V	50A	50	12.1
SS-5F-2.5A	250V	50A	40	16.8
SS-5F-3.15A	250V	50A	32	32.4
SS-5F-4A	250V	50A	25	48.4
*SS-5F-5A	250V	50A	17	75.0
*SS-5F-6.3A	125V	50A	14	108
*SS-5F-7A	125V	50A	11	160
*SS-5F-8A	125V	50A	9	190
*SS-5F-10A	125V	50A	7	270

* Conducting Path min. 0.2mm²

TIME CURRENT CURVE

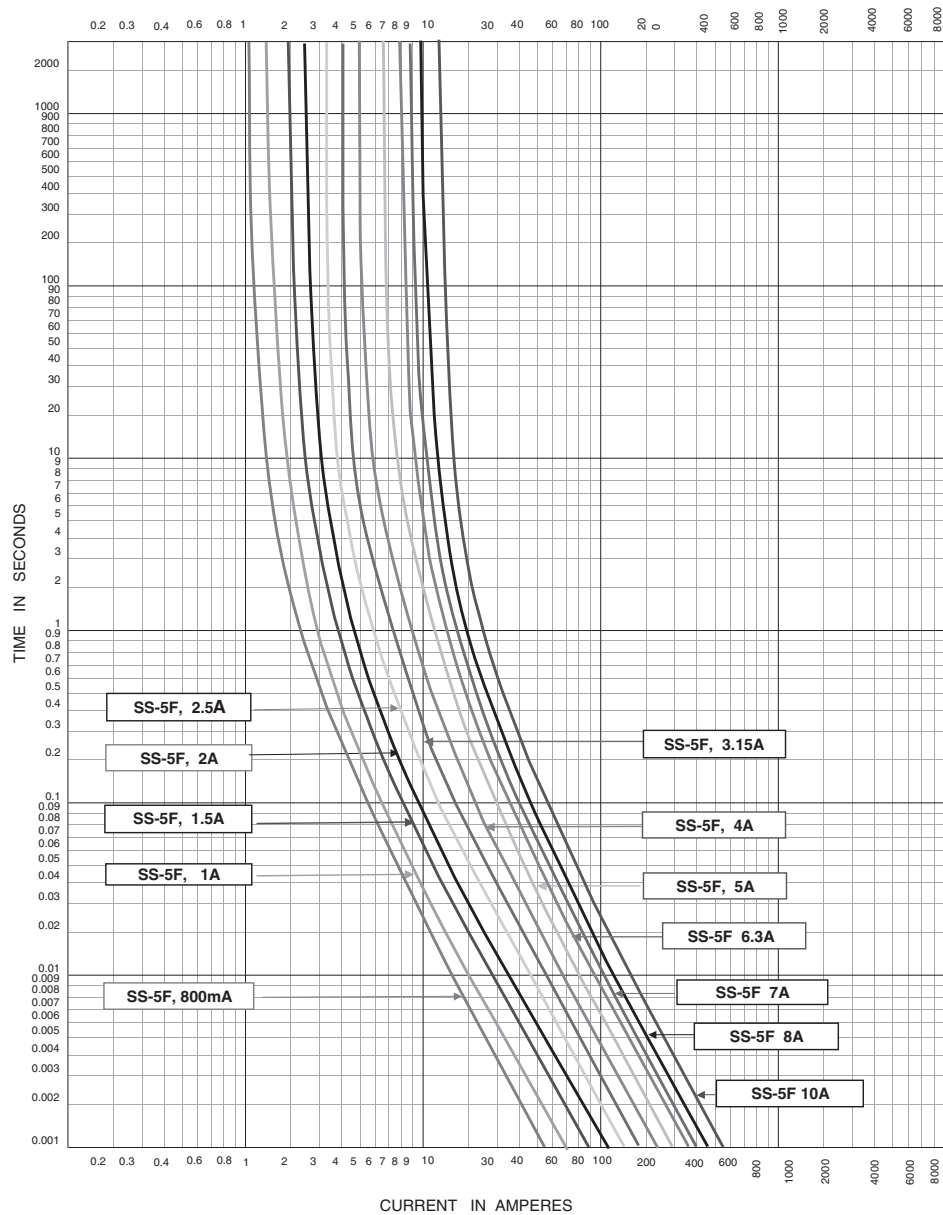

PACKAGING CODE	
Packaging Code	Description
-AP	Ammo-pack taped 1,000 per box
-BK	In bulk 200 per bag

Subminiature Fuses

SR-5H Series, Time Lag

Description

- Radial Leaded Time Lag Thru-Hole Fuse
- Designed to IEC 60127-3, Sheet 4
- Ideal for electronic lighting ballasts
- cURus Recognized at 300V/100A
- Internationally accepted for primary and secondary overcurrent protection
- Place directly into PCB or plug into BK/PCS holder
- High inrush withstand capability
- Compatible with leaded and lead-free reflow and wave solder
- Base/Cap is Nylon #66, UL 94V0
- Pins are Tin Plated Copper

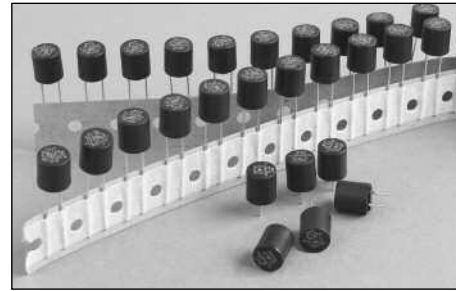

Dimensions mm/(inches)

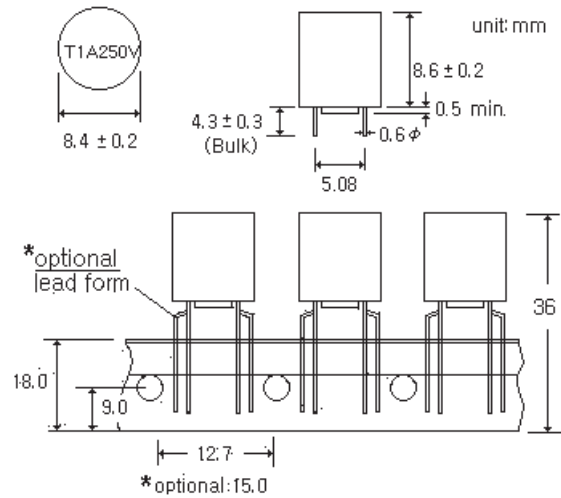

ELECTRICAL CHARACTERISTICS										
Rated Current	1.5 In		2.1 In		2.75 In		4 In		10 In	
	min	max	min	max	min	max	min	max	min	max
1A-6.3A	1hr	2 min	400 ms	10 sec	150 ms	3 sec	20 ms	150 ms		

Agency Information

- cURus: E146895 (1A thru 5A @ 300V/100A)
- PSE: (1A thru 6.3A @ 300V/100A)
- VDE: (1A thru 5A)
- SEMKO: (1A thru 5A) Pending
- CCC (1A thru 6.3A) Pending
- EK: KTL (1A thru 6.3A) Pending

Specifications

- Solderability: EIA-186-9E Method 9
- High Frequency Vibration: MIL-STD-202F, Method 201A
- Operating Temperature: -40°C to +125°C
- Soldering Heat Resistance: 260°C, 10S (IEC 60068-2-20)

Ordering

- Specify product and packaging code (i.e., SR-5H-1A-AP)

SPECIFICATIONS

Product Code	Voltage Rating AC	Interrupting Rating @ Rated Voltage	Typical DC Cold Resistance (ohms)	Typical Melting I ² t (A ² s) at 1ms	Maximum Power Dissipation (mW)
SR-5H-1A	250V	100A	0.083	9	500
SR-5H-1.25A	250V	100A	0.061	13	600
SR-5H-1.6A	250V	100A	0.047	24	730
SR-5H-2A	250V	100A	0.031	30	870
SR-5H-2.5A	250V	100A	0.028	45	1000
SR-5H-3.15A	250V	100A	0.023	57	1200
SR-5H-4A	250V	100A	0.015	80	1400
*SR-5H-5A	250V	100A	0.011	120	1800
*SR-5H-6.3A	250V	100A	0.009	140	2000

* Conducting Path min. 0.2mm²

TIME CURRENT CURVE

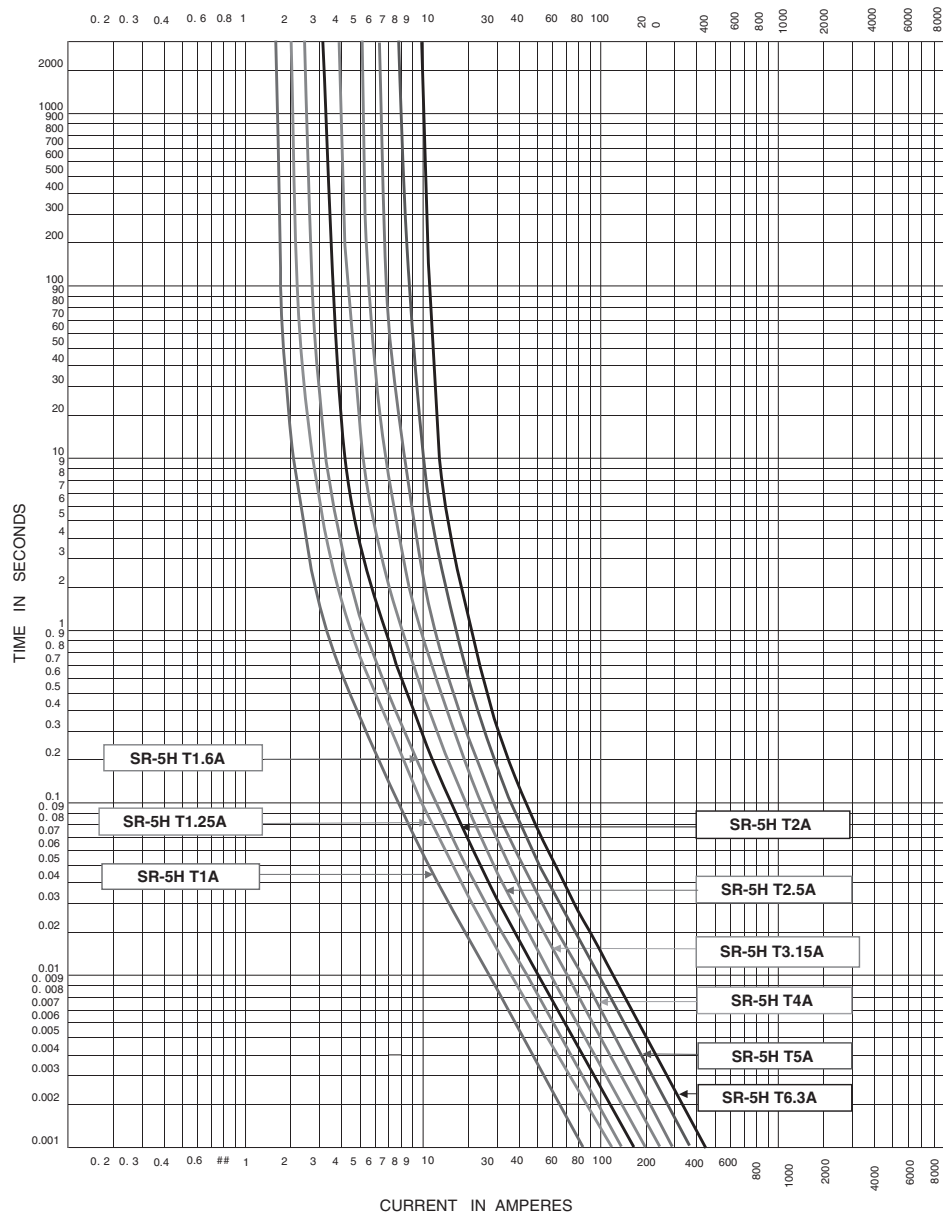

PACKAGING CODE	
Packaging Code	Description
-AP	Ammo-pack taped 1,000 per box
-BK	In bulk 200 per bag

5mm x 15mm Fuses

C515 Series, Time Delay, Glass Tube

Description

- Axial leaded, time delay
- 5mm x 15mm physical size
- Glass tube, nickel-plated brass endcap construction
- Leads are tin coated
- Optional sleeve is flexible flouropolymer (U.L. flammability rating VW-1).
- UL Listed product meets standard UL 248-14

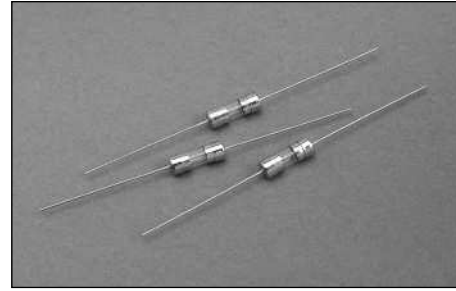

ELECTRICAL CHARACTERISTICS		
Rated Current	Amp Rating	Opening Time
125mA - 250mA	135%	60 minutes max.
	200%	3 seconds min. 120 seconds max.
350mA	100%	4 hours min.
	470mA	30 minutes max.
	600mA	90 seconds max.
	2A	2 seconds max.
375mA - 7A	6A	500 milliseconds max.
	135%	60 minutes max.
	200%	3 seconds min. 120 seconds max.

Agency Information

- UL Listed Card: C515 125mA-250mA and 375mA-3A (Guide JDYX, File E19180)
- UL Recognized Card: C515 350mA, and 3.5A-7A (Guide JDYX2, File E19180)
- CSA Certification Card: C515 125mA-250mA and 375mA-3A (Class 1422-01, LR65063)

Dimensions (mm)

Drawing Not to Scale

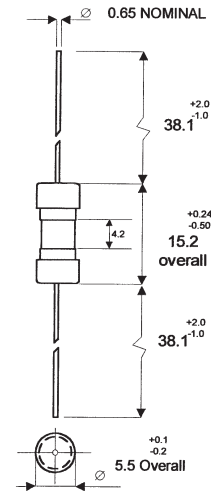

Ordering

- Specify packaging, product, and option code
- For -R option, drop mA or A from product code (i.e. C515-1-R)
- With TR2 packaging code, lead wire length is 20.3mm

SPECIFICATIONS

Product Code	Voltage Rating AC	AC Interrupting Rating			Typical DC Cold Resistance* (ohms)	Typical Melting I ² t† AC	Typical Voltage Drop (mV)‡
		600V	250V	125V			
C515-125mA	250V	-	35A	10000A	4.72	0.101	770
C515-250mA	250V	-	35A	10000A	1.32	0.467	430
C515-350mA	250V	25A	35A	10000A	1.04	1.169	530
C515-375mA	250V	-	35A	10000A	0.81	1.531	470
C515-500mA	250V	-	35A	10000A	0.54	2.280	440
C515-600mA	250V	-	35A	10000A	0.38	6.982	350
C515-750mA	250V	-	35A	10000A	0.26	9.162	310
C515-800mA	250V	-	35A	10000A	0.23	10.544	260
C515-1A	250V	-	35A	10000A	0.14	14.289	230
C515-1.25A	250V	-	100A	10000A	0.13	22.961	220
C515-1.5A	250V	-	100A	10000A	0.100	31.989	240
C515-1.6A	250V	-	100A	10000A	0.090	35.156	200
C515-2A	250V	-	100A	10000A	0.059	60.256	170
C515-2.25A	250V	-	100A	10000A	0.057	97.724	180
C515-2.5A	250V	-	100A	10000A	0.046	78.163	190
C515-3A	250V	-	100A	10000A	0.035	80.426	150
C515-3.5A	125V	-	-	400A	0.028	149.279	130
C515-4A	125V	-	-	400A	0.023	233.346	130
C515-5A	125V	-	-	400A	0.019	354.813	150
C515-6A	125V	-	-	400A	0.014	471.360	125
C515-7A	125V	-	-	400A	0.013	710.500	100

* DC Cold Resistance (Measured at <10% of rated current)
 † Typical Melting I²t (A²Sec) (Minimum I²t at 10 times rated current)
 ‡ Typical Voltage Drop (Voltage drop was measured at 25°C ambient temperature at rated current)

TIME CURRENT CURVE

Nominal Time/Current Characteristics

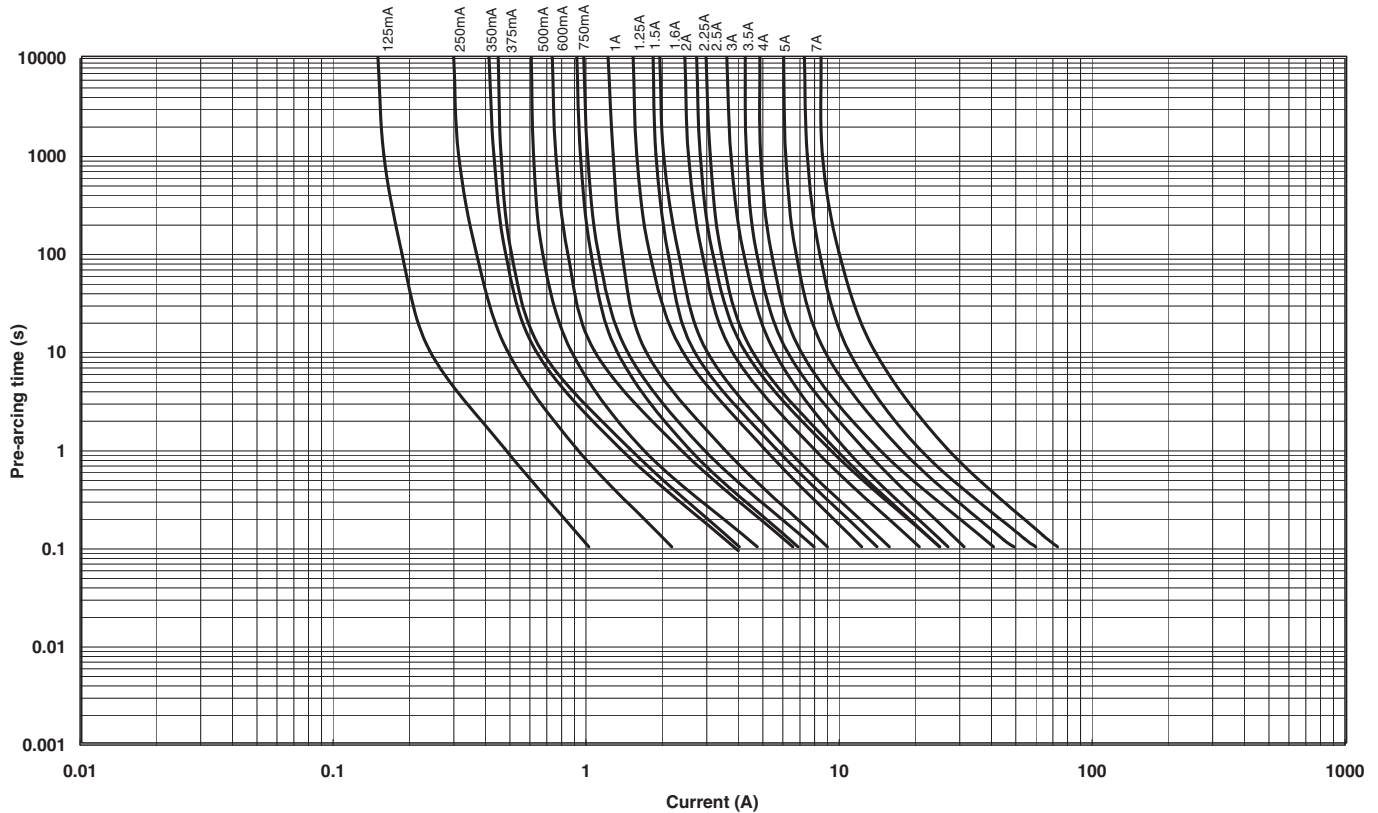

PACKAGING CODE	
Packaging Code	Description
BK	100 pieces of fuses packed into a cardboard carton
TR2	1,500 pieces of fuses packed into tape on a reel (20.3mm lead wire length)

OPTION CODE	
Option Code	Description
S	Insulation Sleeve
-R	RoHS compliant version

5mm x 15mm Fuses

C517 Series, Fast Acting, Glass Tube

Description

- Axial leaded fast acting
- 5mm x 15mm physical size
- Glass tube, nickel-plated brass endcap construction
- Leads are plated with 95% tin, 5% lead
- Optional sleeve is flexible flouropolymer (U.L. flammability rating VW-1).
- UL Listed product meets standard UL 248-14
- High breaking capacity for lighting ballast applications

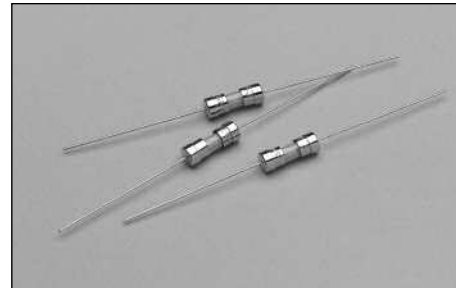

ELECTRICAL CHARACTERISTICS		
Rated Current	Amp Rating	Opening Time
3A	100%	None
	135%	60 minutes max.
	200%	2 seconds max.

Agency Information

- UL Listed Card: C517 3A (Guide JDYX, File E75865)
- UL Recognition Card: C517 3A (Guide JDYX2, File E75865)
- CSA Certification Card: 3A (Class 1422-01, LR65063)

Ordering

- Specify packaging, product, and option code
- For -R option, drop mA or A from product code (i.e. C517-3-R)

Dimensions (mm)

Drawing Not to Scale

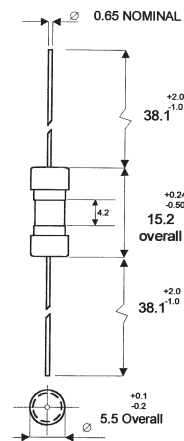

- With TR2 packaging code, lead wire length is 20.3mm

SPECIFICATIONS					
Product Code	Voltage Rating AC	Interrupting Rating at Rated Voltage AC	Typical DC Cold Resistance* (ohms)	Typical Melting I ² t† AC	Typical Voltage Drop (mV)‡
C517-3A	350V**	100A	0.34	5.87	141.7
	250V	100A			
	125V	10,000A			

* DC Cold Resistance (Measured at <10% of rated current)
 † Typical Melting I²t (A²Sec) (Minimum I²t at 10 times rated current)
 ‡ Typical Voltage Drop (Voltage drop was measured at 25°C ambient temperature at rated current)
 ** 350VAC is UL Recognized

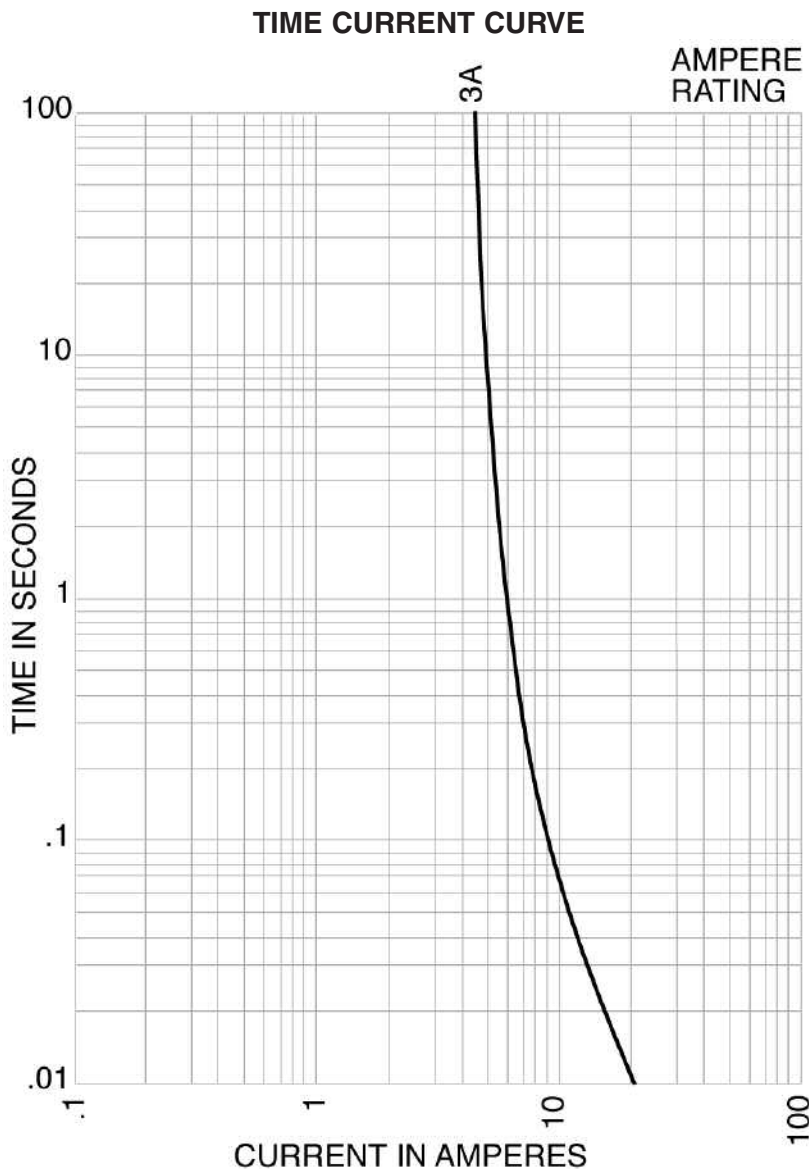

PACKAGING CODE	
Packaging Code	Description
BK	100 pieces of fuses packed into a cardboard carton
TR2	1,500 pieces of fuses packed into tape on a reel (20.3mm lead wire length)

OPTION CODE	
Option Code	Description
S	Insulation Sleeve
-R	RoHS compliant version

5mm x 15mm Fuses

C518 Series, Fast Acting, Glass Tube

Description

- Axial leaded fast acting
- 5mm x 15mm physical size
- Glass tube, nickel-plated brass endcap construction
- Leads are plated with 95% tin, 5% lead
- Optional sleeve is flexible flouropolymer (U.L. flammability rating VW-1).
- UL Listed product meets standard UL 248-14

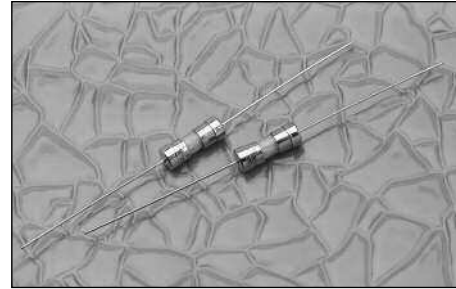

ELECTRICAL CHARACTERISTICS		
Rated Current	Amp Rating	Opening Time
100mA-5A	100%	None
	135%	60 minutes max.
	200%	2 seconds max.

Agency Information

- UL Listed Card: Guide JDYX, File E19180
- CSA Certification Card: Class 1422-01, LR65063

Ordering

- Specify packaging, product, and option code
- For -R option, drop mA or A from product code (i.e. C518-3-R)

Dimensions (mm)

Drawing Not to Scale

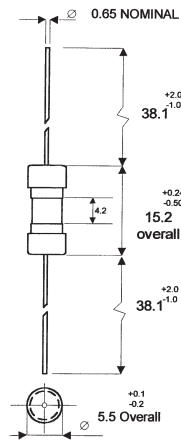

- With TR2 packaging code, lead wire length is 20.3mm

SPECIFICATIONS

Product Code	Voltage Rating AC	Interrupting Rating at Rated Voltage		Typical DC Cold Resistance* (ohms)	Typical Melting I ² t† AC	Typical Voltage Drop (mV)‡
		250VAC	125VAC			
C518-100mA	250V	35A	10,000A	22.30	0.0010	2230
C518-125mA	250V	35A	10,000A	15.20	0.0019	1930
C518-250mA	250V	35A	10,000A	5.66	0.012	1450
C518-375mA	250V	35A	10,000A	2.53	0.039	968
C518-500mA	250V	35A	10,000A	1.66	0.059	845
C518-750mA	250V	35A	10,000A	0.91	0.264	686
C518-1.5A	250V	100A	10,000A	0.900	0.800	135
C518-2A	250V	100A	10,000A	0.064	1.9	136
C518-2.5A	250V	100A	10,000A	0.046	2.9	121
C518-3A	250V	100A	10,000A	0.038	6.1	116
C518-3.5A	250V	100A	10,000A	0.032	9.7	115
C518-4A	250V	200A	10,000A	0.022	16.6	88
C518-5A	250V	200A	10,000A	0.018	22.4	91

* DC Cold Resistance (Measured at <10% of rated current)

† Typical Melting I²t (A²Sec) (Minimum at 10 times rated current)

‡ Typical Voltage Drop (Voltage drop was measured at 20°C ambient temperature at rated current)

TIME CURRENT CURVE
Time-Current Characteristic Curves—Average Melt

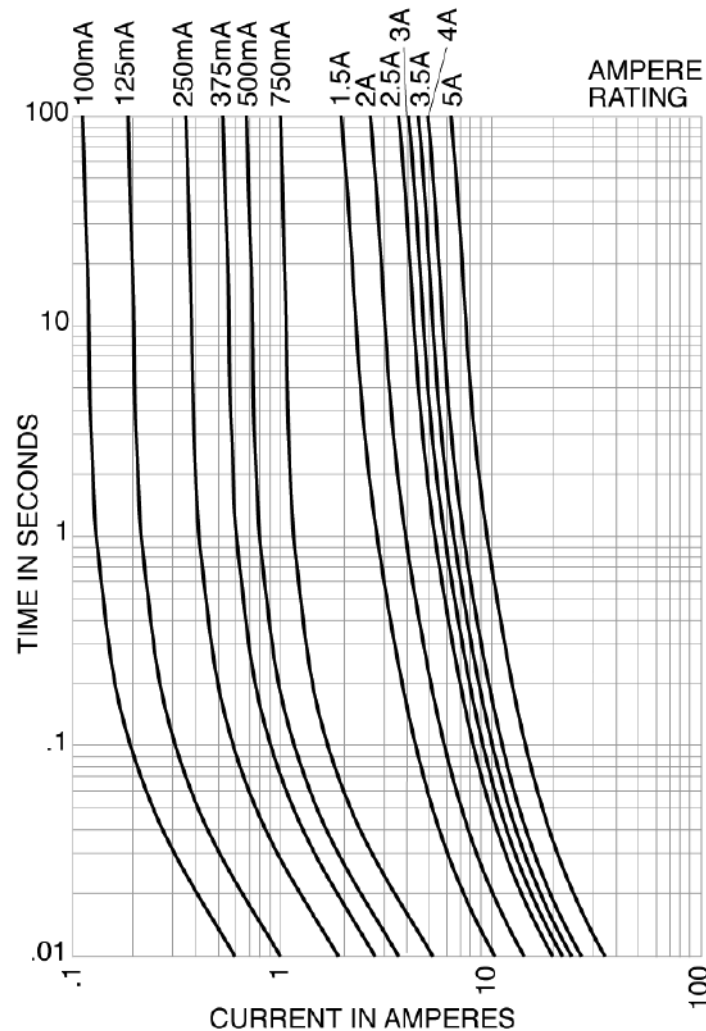

PACKAGING CODE	
Packaging Code	Description
BK	100 pieces of fuses packed into a cardboard carton
TR2	1,500 pieces of fuses packed into tape on a reel (20.3mm lead wire length)

OPTION CODE	
Option Code	Description
S	Insulation Sleeve
-R	RoHS compliant version

5mm x 15mm Fuses

C519 Series, Time Delay, Glass Tube

Description

- Time delay
- 5mm x 15mm physical size
- Glass tube, nickel-plated brass endcap construction
- Optional sleeve is flexible fluoropolymer (U.L. flammability rating VW-1).
- UL Listed product meets standard UL 248-14



ELECTRICAL CHARACTERISTICS		
Rated Current	Amp Rating	Opening Time
125mA - 250mA	135%	60 minutes max.
	200%	3 seconds min. 120 seconds max.
350mA	100%	4 hours min.
	470mA	30 minutes max.
	600mA	90 seconds max.
	2A	2 seconds max.
375mA - 5A	6A	500 milliseconds max.
	135%	60 minutes max.
	200%	3 seconds min. 120 seconds max.

Dimensions

Drawing Not to Scale

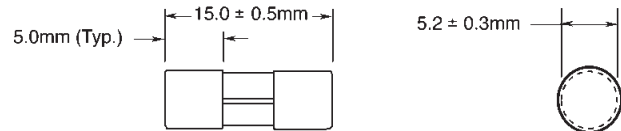

Agency Information

- UL Listed Card: C519 125mA-250mA and 375mA-3A (Guide JDYX, File E19180)
- UL Recognized Card: C519 350mA, and 3.5A-7A (Guide JDYX2, File E19180)
- CSA Certification Card: C519 125mA-250mA and 375mA-3A (Class 1422-01, LR65063)

Ordering

- Specify packaging, product, and option code
- For -R option, drop mA or A from product code (i.e. C519-3-R)

SPECIFICATIONS

Product Code	Voltage Rating AC	Interrupting Rating at Rated Voltage			Typical DC Cold Resistance* (ohms)	Typical Melting I ² t† AC	Typical Voltage Drop (mV)‡
		600V	250V	125V			
C519-125mA	250V	-	35A	10,000A	4.72	0.101	770
C519-250mA	250V	-	35A	10,000A	1.32	0.467	430
C519-350mA	250V	25A	35A	10,000A	1.04	1.169	530
C519-375mA	250V	-	35A	10,000A	0.81	1.531	470
C519-500mA	250V	-	35A	10,000A	0.54	2.280	440
C519-600mA	250V	-	35A	10,000A	0.38	6.982	350
C519-750mA	250V	-	35A	10,000A	0.26	9.162	310
C519-1A	250V	-	35A	10,000A	0.14	14.289	230
C519-1.25A	250V	-	100A	10,000A	0.13	22.961	220
C519-1.5A	250V	-	100A	10,000A	0.10	31.989	240
C519-1.6A	250V	-	100A	10,000A	0.09	31.156	200
C519-2A	250V	-	100A	10,000A	0.059	60.256	170
C519-2.25A	250V	-	100A	10,000A	0.057	97.724	180
C519-2.5A	250V	-	100A	10,000A	0.046	78.163	190
C519-3A	250V	-	100A	10,000A	0.035	80.426	150
C519-3.5A	125V	-	-	400A	0.028	149.279	130
C519-4A	125V	-	-	400A	0.023	233.346	130
C519-5A	125V	-	-	400A	0.019	354.813	150

* DC Cold Resistance (Measured at <10% of rated current)

† Typical Melting I²t (A²Sec) (Typical I²t at 10 times rated current)

‡ Typical Voltage Drop (Voltage drop was measured at 25°C±3°C ambient temperature at rated current)

TIME CURRENT CURVE

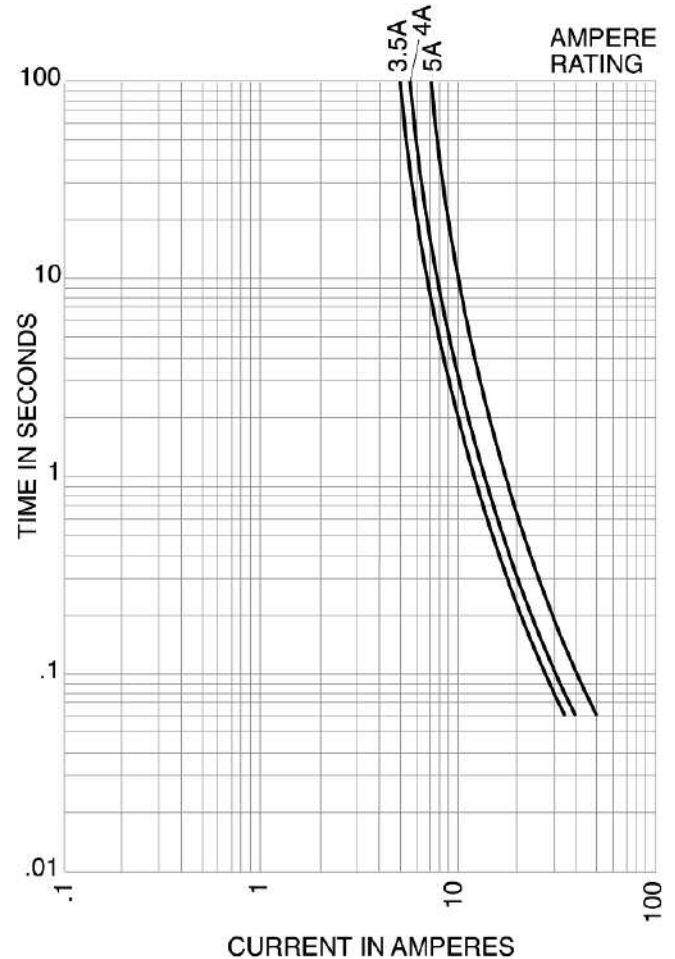
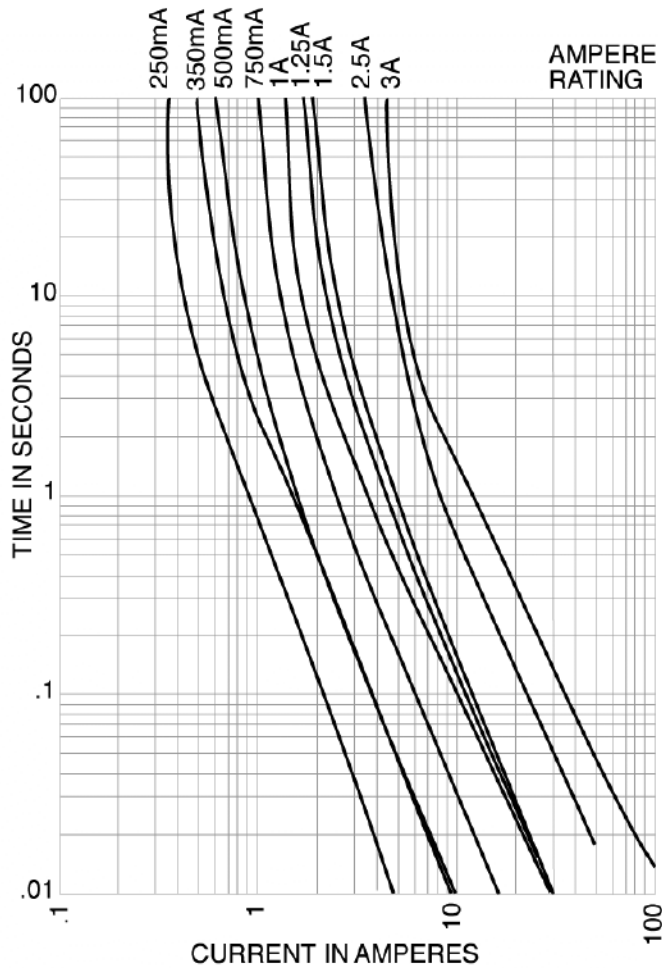

PACKAGING CODE

Packaging Code	Description
BK	100 pieces of fuses packed into a cardboard carton
BK1	1,000 pieces of fuses packed into a cardboard carton

OPTION CODE

Option Code	Description
S	Insulation Sleeve
-R	RoHS compliant version

Description

- Fast acting
- 5mm x 15mm physical size
- Glass tube, nickel-plated brass endcap construction
- Optional sleeve is flexible fluoropolymer (U.L. flammability rating VW-1).
- UL Listed product meets standard UL 248-14



ELECTRICAL CHARACTERISTICS		
Rated Current	Amp Rating	Opening Time
100mA - 5A	100%	None
	135%	1 hours max.
	200%	2 seconds max.

Agency Information

- UL Listed Card: Guide JDYX, File E19180
- CSA Certification Card: Class 1422-01, LR65063

Ordering

- Specify packaging, product, and option code
- For -R option, drop mA or A from product code (i.e. C520-3-R)

Dimensions

Drawing Not to Scale

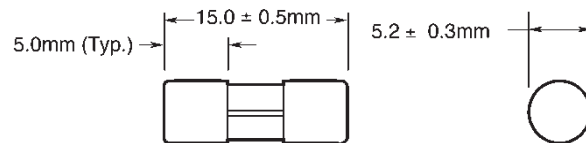

Product Code	Voltage Rating AC	Interrupting Rating at Rated Voltage		Typical DC Cold Resistance* (ohms)	Typical Melting I ² t† AC	Typical Voltage Drop (mV)‡
		250VAC	125VAC			
C520-100mA	250V	35A	10,000A	22.30	0.0010	2230
C520-125mA	250V	35A	10,000A	15.20	0.0019	1930
C520-250mA	250V	35A	10,000A	5.60	0.012	1450
C520-375mA	250V	35A	10,000A	2.53	0.039	968
C520-500mA	250V	35A	10,000A	1.66	0.059	845
C520-750mA	250V	35A	10,000A	0.91	0.264	686
C520-1.5A	250V	100A	10,000A	0.900	0.800	135
C520-2A	250V	100A	10,000A	0.064	1.9	136
C520-2.5A	250V	100A	10,000A	0.046	2.9	121
C520-3A	250V	100A	10,000A	0.038	6.1	116
C520-3.5A	250V	100A	10,000A	0.032	9.7	115
C520-4A	250V	200A	10,000A	0.022	16.6	88
C520-5A	250V	200A	10,000A	0.018	22.4	91

* DC Cold Resistance (Measured at <10% of rated current)

† Typical Melting I²t (A²Sec) (maximum I²t at 10 times rated current)

‡ Typical Voltage Drop (Voltage drop was measured at 25°C±3°C ambient temperature at rated current)

TIME CURRENT CURVE
Time-Current Characteristic Curves—Average Melt

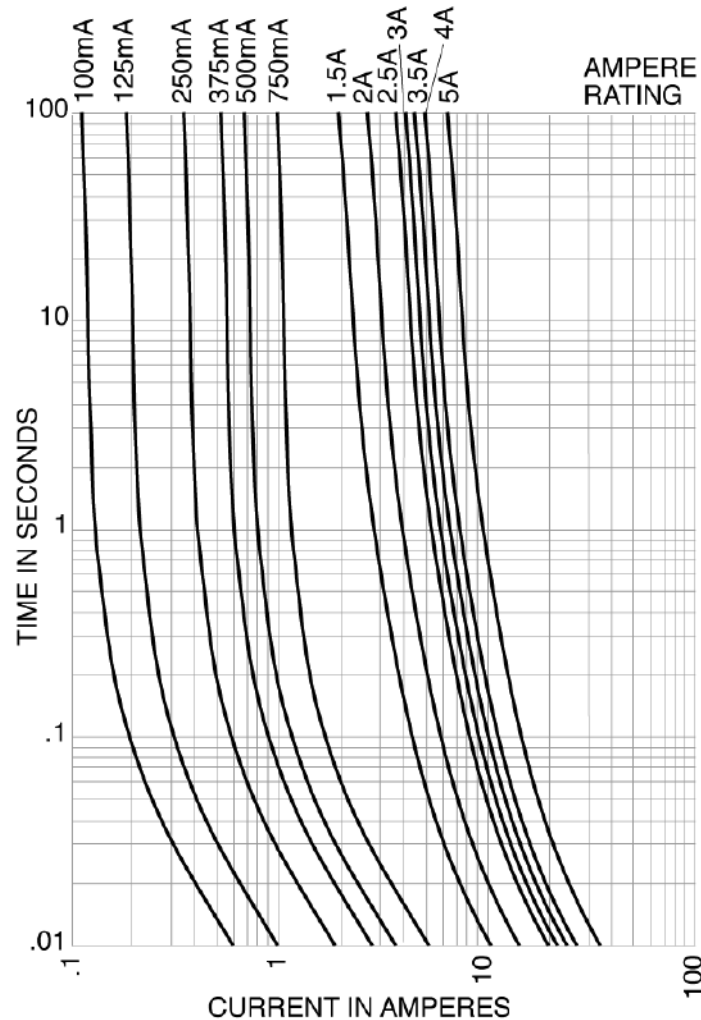

PACKAGING CODE

Packaging Code	Description
BK	100 pieces of fuses packed into a cardboard carton
BK1	1,000 pieces of fuses packed into a cardboard carton

OPTION CODE

Option Code	Description
S	Insulation Sleeve
-R	RoHS compliant version

5mm x 20mm Fuses

S500 Series, Fast Acting, Glass Tube

Description

- Fast acting, low breaking capacity
- Optional Axial leads available
- 5mm x 20mm physical size
- Glass tube, nickel-plated brass endcap construction
- Designed to IEC 60127-2 (32mA-6.3A)



ELECTRICAL CHARACTERISTICS							
In	1.5 In min	2.1 In max	2.75 In		4 In		10 In max
	min	max	min	max	min	max	max
32mA-100mA	60 min	30 min	10 ms	500 ms	3 ms	100 ms	20 ms
125mA-6.3A	60 min	30 min	50 ms	2 sec	10 ms	300 ms	20 ms

Agency Information

- UL Recognized Card: (32mA-10A) Guide JDYX2, File E19180
- CSA Component Acceptance: File 53787
- cURus Recognition: Guide JDYX8, File E19180
- SEMKO Approval 160mA-10A
- VDE Approval 160mA-10A
- BSI Approval 160mA-10A
- IMQ Approval 160mA-10A
- CCC Approval 160mA-6.3A

Ordering

- Specify packaging, product, and option code
- For -R option, drop mA or A from product code (i.e. S500-2-R)

Dimensions

Drawing Not to Scale

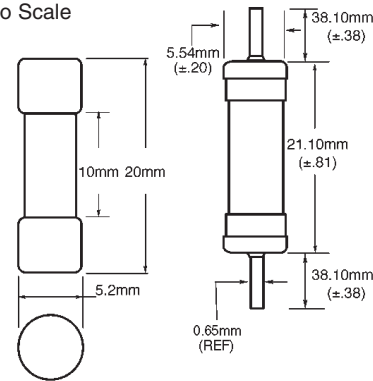

- Ratings above 6.3A have a 0.8mm diameter lead
- With TR2 packaging code, lead wire length is 19.05mm

SPECIFICATIONS

Product Code	Voltage Rating AC	Interrupting Rating at Rated Voltage (50Hz) AC	Typical DC Cold Resistance (ohms)*	Typical Melting I ² t (A ² Sec) AC†	Maximum Voltage Drop (mV)‡
S500-32mA	250V	35A	41.5	0.000047	3200
S500-40mA	250V	35A	25.5	0.00011	2500
S500-50mA	250V	35A	17.5	0.00020	2400
S500-63mA	250V	35A	12.9	0.00057	2000
S500-80mA	250V	35A	5.2	0.0012	1200
S500-100mA	250V	35A	3.9	0.003	1100
S500-125mA	250V	35A	2.9	0.005	1000
S500-160mA	250V	35A	9.2	0.008	2000
S500-200mA	250V	35A	7.0	0.016	1700
S500-250mA	250V	35A	4.5	0.28	1400
S500-315mA	250V	35A	3.2	0.58	1300
S500-400mA	250V	35A	1.9	0.18	1100
S500-500mA	250V	35A	0.27	0.18	220
S500-630mA	250V	35A	0.21	0.35	220
S500-800mA	250V	35A	0.15	0.67	190
S500-1A	250V	35A	0.13	0.60	200
S500-1.25A	250V	35A	0.098	0.84	200
S500-1.6A	250V	35A	0.068	1.6	190
S500-2A	250V	35A	0.044	4.2	150
S500-2.5A	250V	35A	0.035	6.1	150
S500-3.15A	250V	35A	0.026	13	130
S500-4A	250V	40A	0.022	22	130
S500-5A	250V	50A	0.015	42	120
S500-6.3A	250V	63A	0.010	69	120
S500-8A	250V	80A	N/A	N/A	N/A
S500-10A	250V	100A	N/A	N/A	N/A

* DC Cold Resistance (Measured at <10% of rated current)

† Typical Melting I²t (I²t was measured at listed interrupting rating and rated voltage)

‡ Maximum Voltage Drop (Voltage drop was measured at 20°C ambient temperature at rated current)

TIME CURRENT CURVE
Time-Current Characteristic Curves—Average Melt

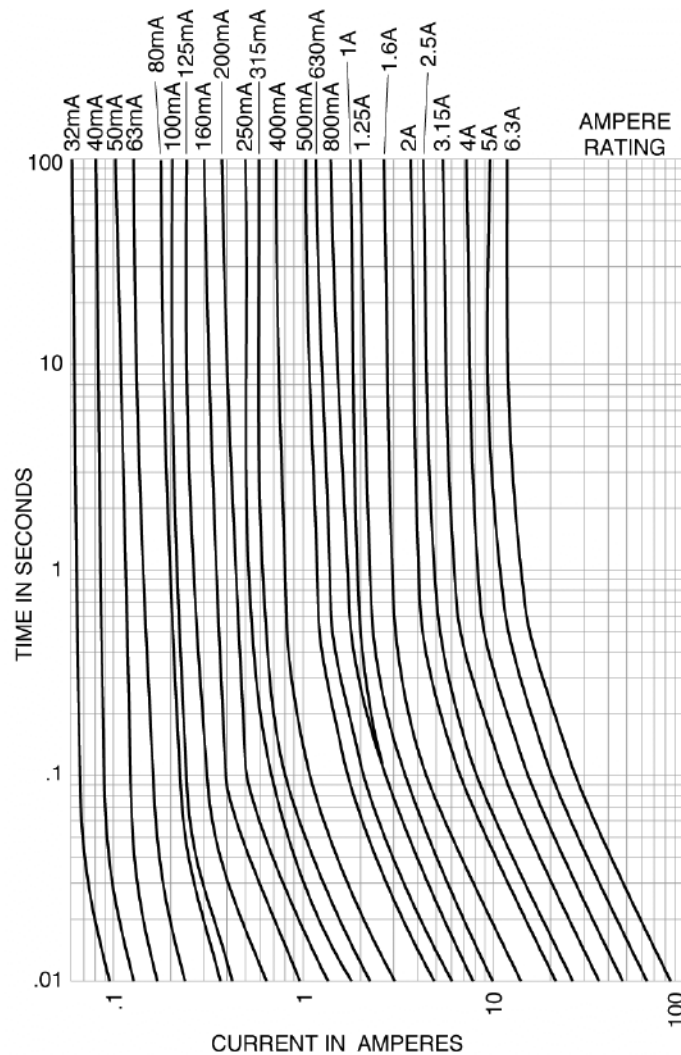

PACKAGING CODE	
Packaging Code	Description
BK	100 pieces of fuses packed into a cardboard carton
BK1	1,000 pieces of fuses packed into a poly bag
TR2	1,500 pieces of fuses packed into tape on a reel (19.05mm lead wire length)

OPTION CODE	
Option Code	Description
V	Axial leads - copper tinned wire with nickel plated brass overcaps
-R	RoHS compliant version

5mm x 20mm Fuses

S501 Series, Fast Acting, Ceramic Tube

Description

- Fast acting
- Optional axial leads available
- 5mm x 20mm physical size
- Ceramic tube, nickel brass endcap construction
- Designed to IEC 60127-2

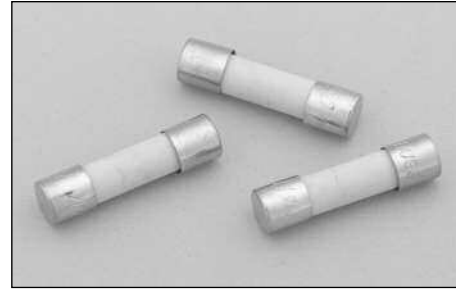

ELECTRICAL CHARACTERISTICS									
In	1.5 In		2.1 In		2.75 In		4 In		10 In
	min	max	min	max	min	max	min	max	max
50mA-3.15A	60 min	30 min	10 ms	2 sec	3 ms	300 ms	20 ms		
4A-10A	60 min	30 min	10 ms	3 sec	3 ms	300 ms	20 ms		

Agency Information

- UL Recognized Card: (50mA-10A) Guide JDYX2, File E19180
- CSA Component Acceptance: File 53787
- cURus Recognition: Guide JDYX8, File E19180
- SEMKO Approval 50mA, 160mA-10A
- VDE Approval 160mA-10A
- IMQ Approval 50mA-10A
- CCC Approval 160mA-10A

Ordering

- Specify packaging, product, and option code
- For -R option, drop mA or A from product code (i.e. S501-2-R)

Dimensions

Drawing Not to Scale

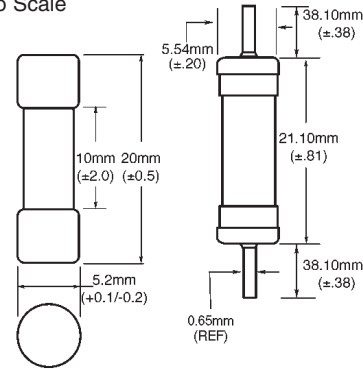

- Ratings above 6.3A have a 0.8mm diameter lead
- With TR2 packaging code, lead wire length is 19.05mm

SPECIFICATIONS

Product Code	Voltage Rating AC	Interrupting Rating at Rated Voltage AC	Typical Melting I ² t (A ² Sec) AC	Typical Voltage Drop (mV)‡
S501-50mA	250V	1500A	0.0017	9000
S501-63mA	250V	1500A	0.0005	3300
S501-80mA	250V	1500A	0.0011	2600
S501-100mA	250V	1500A	0.0018	2300
S501-125mA	250V	1500A	0.0037	1900
S501-160mA	250V	1500A	0.008	1600
S501-200mA	250V	1500A	0.020	1350
S501-250mA	250V	1500A	0.027	1300
S501-315mA	250V	1500A	0.010	1400
S501-400mA	250V	1500A	0.018	1200
S501-500mA	250V	1500A	0.038	1050
S501-630mA	250V	1500A	0.064	1200
S501-800mA	250V	1500A	0.097	490
S501-1A	250V	1500A	0.480	230
S501-1.25A	250V	1500A	0.9	200
S501-1.6A	250V	1500A	1.9	180
S501-2A	250V	1500A	2.0	205
S501-2.5A	250V	1500A	3.9	190
S501-3.15A	250V	1500A	8.1	160
S501-4A	250V	1500A	14	160
S501-5A	250V	1500A	25	155
S501-6.3A	250V	1500A	48	150
S501-8A	250V	1500A	N/A	N/A
S501-10A	250V	1500A	N/A	N/A

‡ Typical Voltage Drop (Voltage drop was measured at 20°C ambient temperature at rated current)

TIME CURRENT CURVE

Time-Current Characteristic Curves—Average Melt

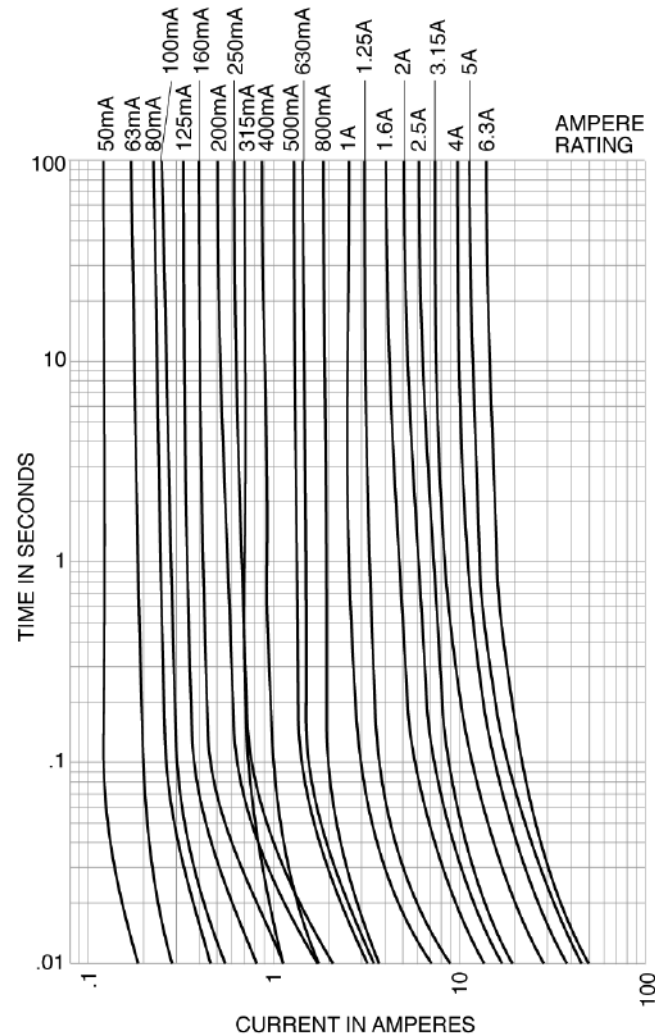

PACKAGING CODE	
Packaging Code	Description
BK	100 pieces of fuses packed into a cardboard carton
BK1	1,000 pieces of fuses packed into a poly bag
TR2	1,500 pieces of fuses packed into tape on a reel (19.05mm lead wire length)

OPTION CODE	
Option Code	Description
V	Axial leads - copper tinned wire with nickel plated brass overcaps
-R	RoHS compliant version

5mm x 20mm Fuses

S505 Series, Time Delay, Ceramic Tube

Description

- Time delay, high breaking capacity
- Optional axial leads available
- 5mm x 20mm physical size
- Ceramic tube, nickel plated brass endcap construction
- Designed to IEC 60127-2 (1A-12A)

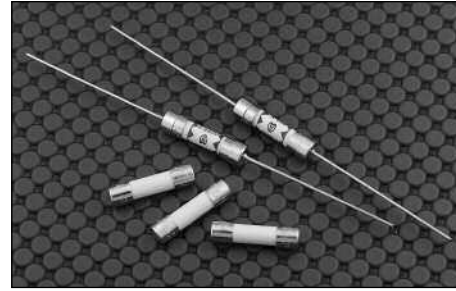

ELECTRICAL CHARACTERISTICS										
In	1.5 In		2.1 In		2.75 In		4 In		10 In	
	min	max	min	max	min	max	min	max	min	max
<1A	60 min	30 min	250 ms	80 sec	50 ms	5 sec	5 ms	55 ms		
1A-3.15A	60 min	30 min	1 sec	80 sec	95 ms	5 sec	10 ms	100 ms		
4A-10A	60 min	30 min	1 sec	80 sec	150 ms	5 sec	20 ms	100 ms		
12.5A	--	30 min	1 sec	80 sec	150 ms	5 sec	20 ms	100 ms		

Agency Information

- UL Recognized Card: (500mA-12A) Guide JDYX2, File E19180
- CSA Component Acceptance: File 53787, 500mA-10A
- SEMKO Approval, 500mA-10A
- VDE Approval, 500mA-10A
- BSI Approval, 500mA-10A
- IMQ Approval, 500mA-10A
- CCC Approval, 500mA-6.3A

Ordering

- Specify packaging, product, and option code
- For -R option, drop mA or A from product code (i.e. S505-3-R)

Dimensions

Drawing Not to Scale

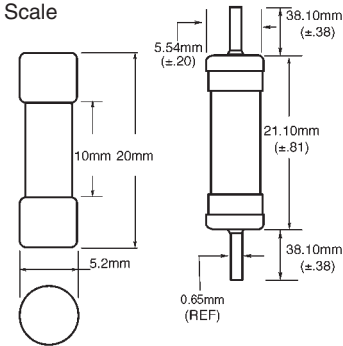

- Ratings above 6.3A have a 0.8mm diameter lead
- With TR2 packaging code, lead wire length is 19.05mm

SPECIFICATIONS

Product Code	Voltage Rating AC	Interrupting Rating at Rated Voltage (50Hz) AC	Typical DC Cold Resistance (ohms)*	Typical Melting I ² t (A ² Sec) AC†	Typical Voltage Drop (mV)‡
S505-500mA	250V	1500A	0.507	-	295
S505-800mA	250V	1500A	0.237	-	189
S505-1A	250V	1500A	0.138	0.74	170
S505-1.25A	250V	1500A	0.089	1.6	150
S505-1.6A	250V	1500A	0.060	3.5	130
S505-2A	250V	1500A	0.041	7.6	110
S505-2.5A	250V	1500A	0.030	14	100
S505-3.15A	250V	1500A	0.021	27	90
S505-4A	250V	1500A	0.015	52	85
S505-5A	250V	1500A	0.011	98	80
S505-6.3A	250V	1500A	0.008	197	75
S505-8A	250V	1500A	0.007	311	75
S505-10A	250V	1500A	0.006	397	72
S505-12A	250V	1000A	0.005	714*	77

* DC Cold Resistance (Measured at <10% of rated current)
 † Typical Melting I²t (I²t was measured at listed interrupting rating and rated voltage)
 ‡ Typical Voltage Drop (Voltage drop was measured at 20°C ambient temperature at rated current)
 x Typical Melting I²t was measured at 10 times the rated current under DC

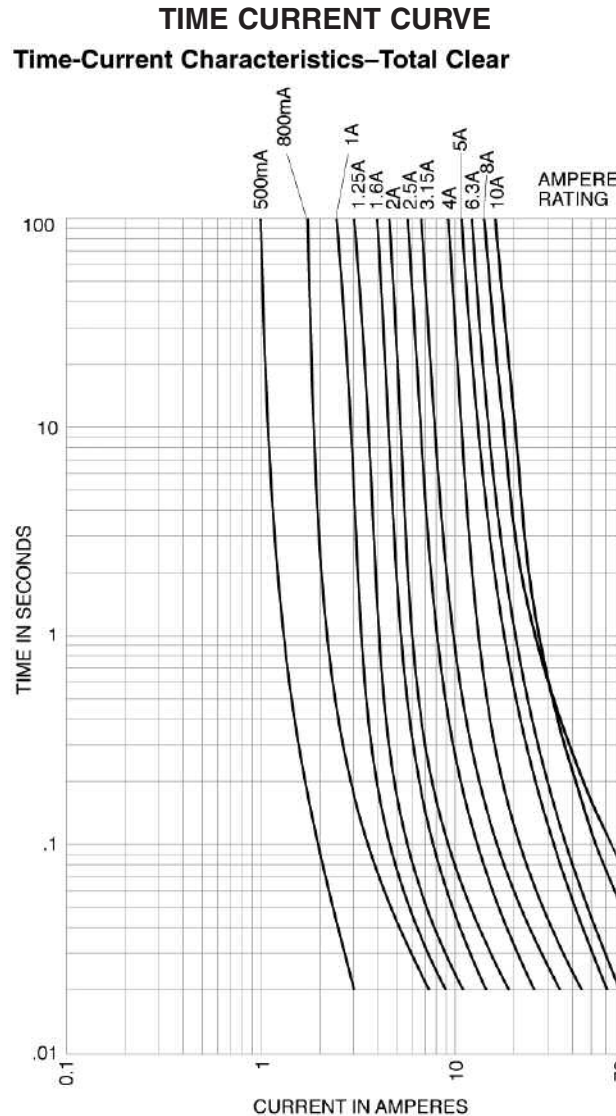

PACKAGING CODE	
Packaging Code	Description
BK	100 pieces of fuses packed into a cardboard carton
BK1	1,000 pieces of fuses packed into a poly bag
TR2	1,500 pieces of fuses packed into tape on a reel (19.05mm lead wire length)

OPTION CODE	
Option Code	Description
V	Axial leads - copper tinned wire with nickel plated brass overcaps
-R	RoHS compliant version

5mm x 20mm Fuses

S506 Series, Time Delay, Glass Tube

Description

- Time delay, low breaking capacity
- Optional axial leads available
- 5mm x 20mm physical size
- Glass tube, nickel-plated brass endcap construction
- Designed to IEC 60127-2 (32mA-10A)



S506 ELECTRICAL CHARACTERISTICS								
In	2.1 In		2.75 In		4 In		10 In	
	max	min	max	min	max	min	max	
32mA-100mA	2 min	200 ms	10 sec	40 ms	3 sec	10 ms	300 ms	
125mA-6.3A	2 min	600 ms	10 sec	150 ms	3 sec	20 ms	300 ms	
8A-15A	2 min	600 ms	10 sec	150 ms	3 sec	20 ms	300 ms	

Agency Information

- UL Recognized Card: (32mA-15A) Guide JDYX2, File E19180
- CSA Component Acceptance: File 53787
- cURus Recognition: Guide JDYX8, File E19180
- SEMKO Approval, 32mA-10A
- VDE Approval, 32mA-10A
- BSI Approval, 32mA-10A
- IMQ Approval, 32mA-10A
- MITI Approval, 32mA-6.3A
- CCC Approval, 32mA-6.3A

Ordering

- Specify packaging, product, and option code
- For -R option, drop mA or A from product code (i.e. S506-2-R)

Dimensions

Drawing Not to Scale

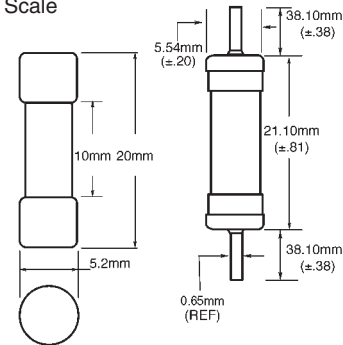

- Ratings above 6.3A have a 0.8mm diameter lead
- With TR2 packaging code, lead wire length is 19.05mm

SPECIFICATIONS

Product Code	Voltage Rating AC	Interrupting Rating at Rated Voltage (50Hz) AC	Typical DC Cold Resistance (ohms)*	Minimum Pre-Arching I ² t (A ² Sec) AC†	Typical Voltage Drop (mV)‡
S506-32mA	250V	35A	21.0	0.0014	1050
S506-40mA	250V	35A	13.90	0.0034	920
S506-50mA	250V	35A	9.24	0.006	800
S506-63mA	250V	35A	6.96	0.012	760
S506-80mA	250V	35A	4.42	0.015	580
S506-100mA	250V	35A	2.74	0.022	490
S506-125mA	250V	35A	1.97	0.034	390
S506-160mA	250V	35A	1.27	0.052	320
S506-200mA	250V	35A	1.00	0.078	340
S506-250mA	250V	35A	0.640	0.17	270
S506-315mA	250V	35A	0.450	0.41	250
S506-400mA	250V	35A	0.308	0.61	210
S506-500mA	250V	35A	0.183	0.67	140
S506-630mA	250V	35A	0.186	1.0	150
S506-800mA	250V	35A	0.128	2.2	75
S506-1A	250V	35A	0.062	2.7	80
S506-1.25A	250V	35A	0.045	6.7	70
S506-1.6A	250V	35A	0.038	9.7	70
S506-2A	250V	35A	0.028	15	68
S506-2.5A	250V	35A	0.023	25	68
S506-3.15A	250V	35A	0.017	51	66
S506-4A	250V	40A	0.012	88	66
S506-5A	250V	50A	0.008	150	66
S506-6.3A	250V	63A	0.008	214	60
S506-8A	250V	80A	0.006	192	55
S506-10A	250V	100A	0.004	420	54
S506-12.5A	250V	125A	0.004	812	45
S506-15A	250V	125A	0.004	1029	73

* DC Cold Resistance (Measured at <10% of rated current)
 † Minimum Pre-Arching I²t (Measured at 10 In and rated voltage)
 ‡ Typical Voltage Drop (Voltage drop was measured at 20°C ambient temperature at rated current)

TIME CURRENT CURVE

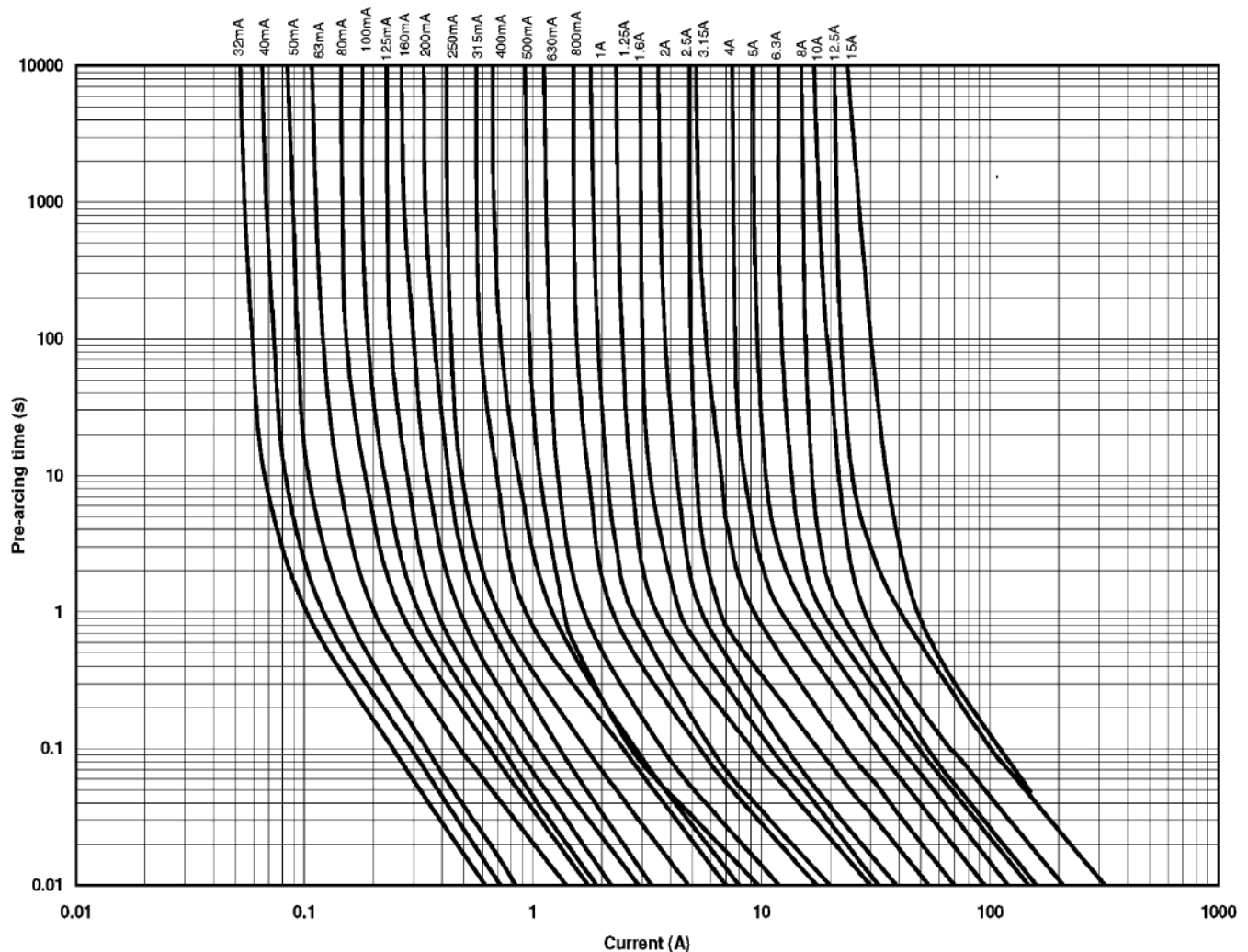

PACKAGING CODE

Packaging Code	Description
BK	100 pieces of fuses packed into a cardboard carton
BK1	1,000 pieces of fuses packed into a poly bag
TR2	1,500 pieces of fuses packed into tape on a reel (19.05mm lead wire length)

OPTION CODE

Option Code	Description
V	Axial leads - copper tinned wire with nickel plated brass overcaps
-R	RoHS compliant version

5mm x 20mm Fuses

GMA Series, Fast Acting, Glass Tube

Description

- Fast acting, low breaking capacity
- Optional axial leads available
- 5mm x 20mm physical size
- Glass tube, nickel-plated brass endcap construction
- Designed to UL/CSA 248-14

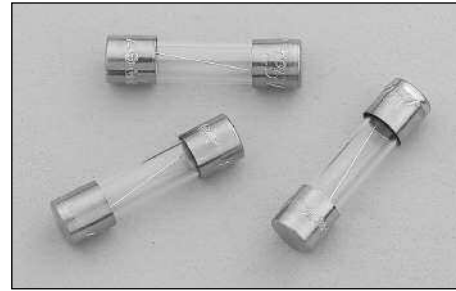

ELECTRICAL CHARACTERISTICS		
Rated Current	% of Amp Rating	Opening Time
63mA - 10A	100%	None
	135%	60 minutes maximum
	200%	2 minutes maximum

Agency Information

- UL Listed, Guide JDYX, File E19180, 63mA-6A
- UL Recognized Card: (7A-15A) Guide JDYX2, File E19180
- CSA Certified, Class 1422-01, File E65063, 63mA-6A
- MITI Approval, 1A-15A
- CCC Approval, 63mA-6A

Ordering

- Specify packaging, product, and option code
- For -R option, drop mA or A from product code (i.e. GMA-2-R)

Dimensions mm/(inches)

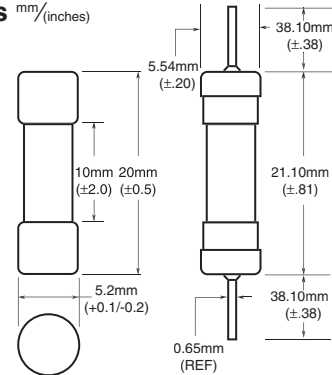

- Ratings above 6.3A have a 0.8mm diameter lead
- With TR2 packaging code, lead wire length is 19.05mm

SPECIFICATIONS

Product Code	Voltage Rating AC	AC Interrupting Rating*		Typical DC Cold Resistance (ohms)**	Typical Pre-Arc I [†] AC†	Maximum Voltage Drop (mV)‡
		250V	125V			
GMA-63mA	250V	35A	10,000A	-	0.00024	4700
GMA-100mA	250V	35A	10,000A	-	0.0001	4300
GMA-125mA	250V	35A	10,000A	-	0.0024	2600
GMA-200mA	250V	35A	10,000A	-	0.001	3400
GMA-250mA	250V	35A	10,000A	-	0.018	2200
GMA-300mA	250V	35A	10,000A	-	0.019	470
GMA-315mA	250V	35A	10,000A	-	0.019	450
GMA-500mA	250V	35A	10,000A	0.454	0.15	230
GMA-600mA	250V	35A	10,000A	0.256	0.32	200
GMA-750mA	250V	35A	10,000A	0.186	0.47	200
GMA-800mA	250V	35A	10,000A	0.170	0.70	180
GMA-1A	250V	35A	10,000A	0.163	0.48	300
GMA-1.25A	250V	100A	10,000A	0.122	0.84	290
GMA-1.5A	250V	100A	10,000A	0.090	1.6	270
GMA-1.6A	250V	100A	10,000A	0.080	2.0	260
GMA-2A	250V	100A	10,000A	0.066	3.1	250
GMA-2.5A	250V	100A	10,000A	0.046	4.9	240
GMA-3A	250V	100A	10,000A	0.039	8.8	215
GMA-3.15A	125V	-	10,000A	0.036	9.7	210
GMA-3.5A	125V	-	10,000A	0.030	13	210
GMA-4A	125V	-	10,000A	0.026	19	205
GMA-5A	125V	-	10,000A	0.021	29	200
GMA-6A	125V	-	10,000A	0.017	45	180
GMA-7A	125V	-	200A	0.012	150	110
GMA-8A	125V	-	200A	0.009	280	110
GMA-10A	125V	-	200A	0.006	280	110
GMA-15A	125V	-	150A	0.004	950	100

* Interrupting ratings: Interrupting ratings for 63mA - 6A were measured at 70% - 80% power factor on AC. The interrupting ratings for 7A - 15A were measured at 100% power factor on AC.

** DC Cold Resistance (Measured at <10% of rated current)

† Typical Pre-Arching I[†] (I[†] was measured at listed interrupting rating and rated voltage)

‡ Maximum Voltage drop (Voltage drop was measured at 20°C ambient temperature at rated current)

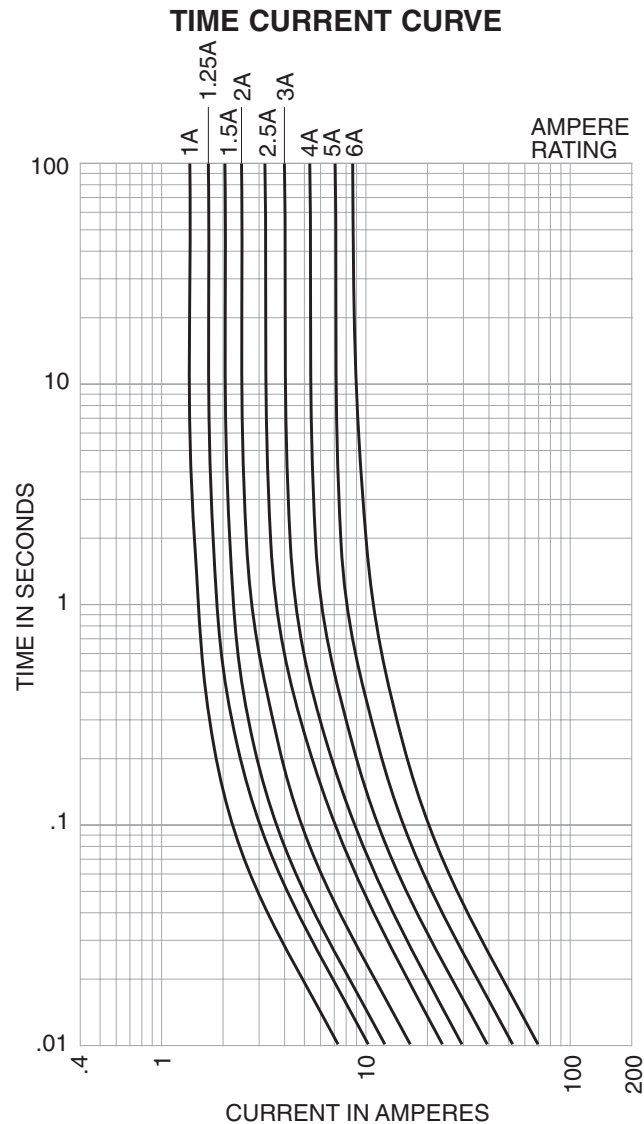

PACKAGING CODE	
Packaging Code	Description
BK	100 pieces of fuses packed into a cardboard carton
BK1	1,000 pieces of fuses packed into a poly bag
TR2	1,500 pieces of fuses packed into tape on a reel (19.05mm lead wire length)

OPTION CODE	
Option Code	Description
V	Axial leads - copper tinned wire with nickel plated brass overcaps
-R	RoHS compliant version

5mm x 20mm Fuses

GMC Series Medium Time Delay, Glass Tube

Description

- Medium time delay, low breaking capacity
- Optional axial leads available
- 5mm x 20mm physical size
- Glass tube, nickel-plated brass endcap construction
- Designed to UL/CSA 248-14

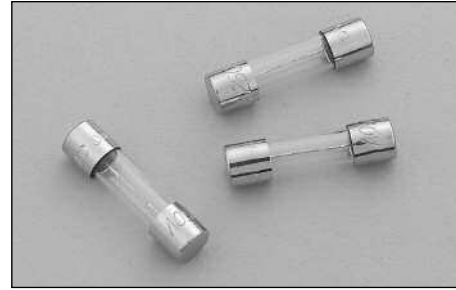

ELECTRICAL CHARACTERISTICS		
Rated Current	% of Amp Rating	Opening Time
63mA - 10A	100%	None
	135%	60 minutes maximum
	200%	2 minutes maximum

Agency Information

- UL Listed, Guide JDYX, File E19180, 63mA-6.3A
- UL Recognized Card: (7A-10A) Guide JDYX2, File E19180
- CSA Certified, Class 1422-01, File E65063, 63mA-6.3A
- MITI Approval, 1A-10A
- CCC Approval, 500mA-6.3A

Ordering

- Specify packaging, product, and option code
- For -R option, drop mA or A from product code (i.e. GMC-2-R)

Dimensions mm/(inches)

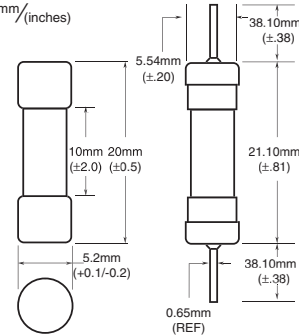

- Ratings above 6.3A have a 0.8mm diameter lead
- With TR2 packaging code, lead wire length is 19.05mm

SPECIFICATIONS

Product Code	Voltage Rating AC	AC Interrupting Rating*		Typical DC Cold Resistance (ohms)**	Typical Pre-Arc I [†] t AC†	Maximum Voltage Drop (mV)‡
		250V	125V			
GMC-63mA	250V	35A	10,000A	10.350	0.0027	1400
GMC-80mA	250V	35A	10,000A	-	0.0050	1400
GMC-100mA	250V	35A	10,000A	4.775	0.0094	1200
GMC-125mA	250V	35A	10,000A	3.400	0.014	1000
GMC-150mA	250V	35A	10,000A	2.555	0.022	800
GMC-160mA	250V	35A	10,000A	2.295	0.022	730
GMC-200mA	250V	35A	10,000A	1.395	0.032	650
GMC-250mA	250V	35A	10,000A	0.965	0.046	490
GMC-300mA	250V	35A	10,000A	0.838	0.081	580
GMC-315mA	250V	35A	10,000A	0.685	0.081	480
GMC-400mA	250V	35A	10,000A	0.615	0.18	510
GMC-500mA	250V	35A	10,000A	0.335	0.41	370
GMC-600mA	250V	35A	10,000A	0.282	0.60	360
GMC-630mA	250V	35A	10,000A	0.246	0.66	360
GMC-700mA	250V	35A	10,000A	0.213	0.85	340
GMC-750mA	250V	35A	10,000A	0.213	0.85	320
GMC-800mA	250V	35A	10,000A	0.180	0.85	290
GMC-1A	250V	35A	10,000A	0.156	1.8	250
GMC-1.25A	250V	100A	10,000A	0.098	3.4	200
GMC-1.5A	250V	100A	10,000A	0.076	5.4	190
GMC-1.6A	250V	100A	10,000A	0.067	5.8	160
GMC-2A	250V	100A	10,000A	0.043	8.9	130
GMC-2.5A	250V	100A	10,000A	0.035	13	130
GMC-3A	250V	100A	10,000A	0.026	19	130
GMC-3.15A	250V	100A	10,000A	0.025	23	130
GMC-3.5A	125V	-	10,000A	0.022	25	130
GMC-4A	125V	-	10,000A	0.019	36	120
GMC-5A	125V	-	10,000A	0.014	58	120
GMC-6A	125V	-	10,000A	0.013	88	120
GMC-6.3A	125V	-	10,000A	0.012	110	120
GMC-7A	125V	-	200A	0.012	150	120
GMC-8A	125V	-	200A	0.009	200	110
GMC-10A	125V	-	200A	0.007	300	110

* Interrupting ratings: Interrupting ratings for 63mA - 6.3A were measured at 70% - 80% power factor on AC. The interrupting ratings for 7A - 10A were measured at 100% power factor on AC.

** DC Cold Resistance (Measured at <10% of rated current)

† Typical Pre-Arching I[†]t (I[†]t was measured at listed interrupting rating and rated voltage)

‡ Maximum Voltage drop (Voltage drop was measured at 20°C ambient temperature at rated current)

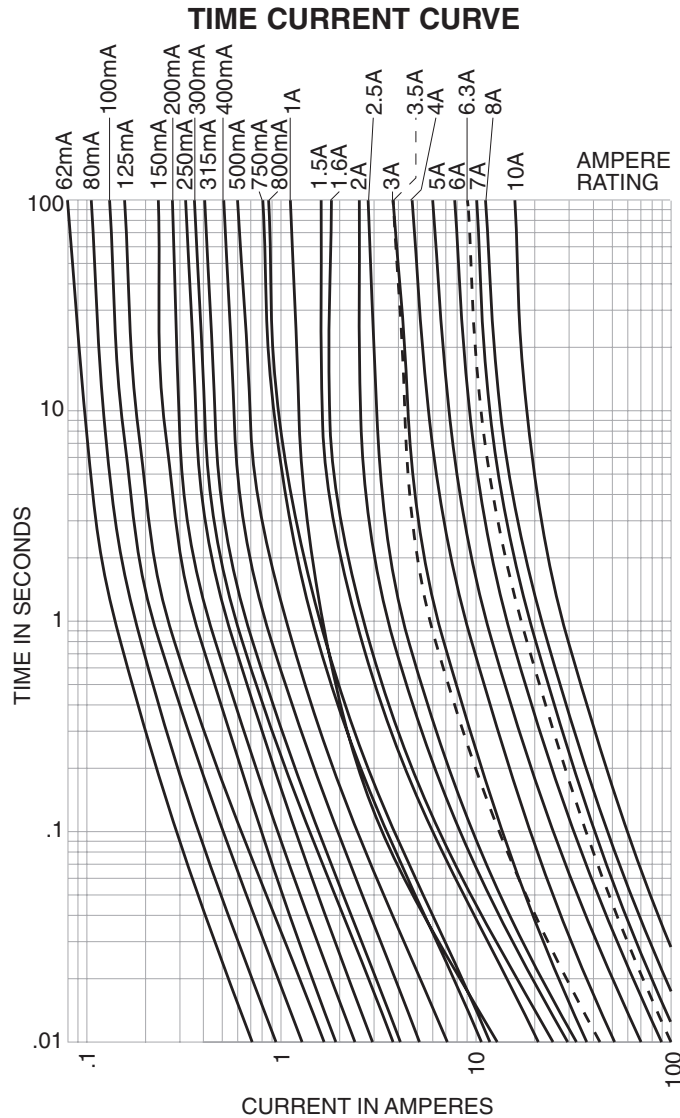

PACKAGING CODE	
Packaging Code	Description
BK	100 pieces of fuses packed into a cardboard carton
BK1	1,000 pieces of fuses packed into a poly bag
TR2	1,500 pieces of fuses packed into tape on a reel (19.05mm lead wire length)

OPTION CODE	
Option Code	Description
V	Axial leads - copper tinned wire with nickel plated brass overcaps
-R	RoHS compliant version

5mm x 20mm Fuses

GMD Series, Time Delay, Glass Tube

Description

- Time delay, low breaking capacity
- Optional axial leads available
- 5mm x 20mm physical size
- Glass tube, nickel-plated brass endcap construction
- Designed to UL/CSA 248-14

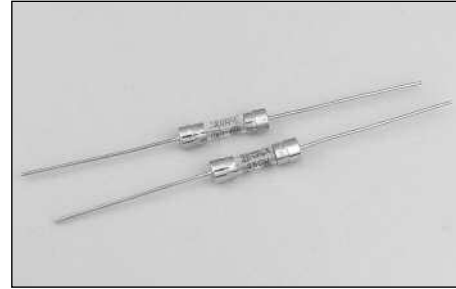

ELECTRICAL CHARACTERISTICS		
Rated Current	% of Amp Rating	Opening Time
100mA - 4A	100%	None
	135%	60 minutes maximum
	200%	5 seconds minimum
		2 minutes maximum

Agency Information

- UL Listed, Guide JDYX, File E19180, 125mA-3A
- UL Recognition Card: (4A) Guide JDYX2, File E19180
- CSA Certified, Class 1422-01, File E65063

Ordering

- Specify packaging, product, and option code
- For -R option, drop mA or A from product code (i.e. GMD-3-R)

Dimensions mm/(inches)

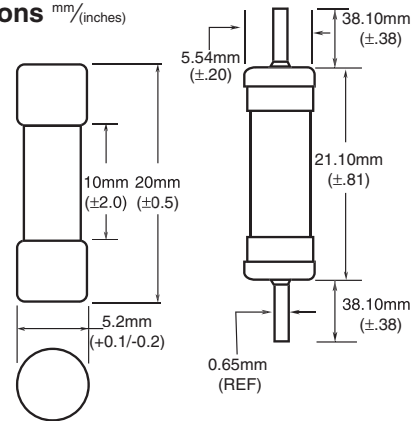

- With TR2 packaging code, lead wire length is 19.05mm

SPECIFICATIONS

Product Code	Voltage Rating AC	AC Interrupting Rating*		Typical DC Cold Resistance (ohms)**	Typical Pre-Arc I [†] AC†	Maximum Voltage Drop (mV)‡
		250V	125V			
GMD-125mA	250V	35A	10,000A	-	0.043	1600
GMD-150mA	250V	35A	10,000A	-	0.046	1200
GMD-200mA	250V	35A	10,000A	-	0.20	1100
GMD-250mA	250V	35A	10,000A	-	0.40	950
GMD-300mA	250V	35A	10,000A	-	0.65	800
GMD-315mA	250V	35A	10,000A	-	0.89	750
GMD-375mA	250V	35A	10,000A	-	0.89	650
GMD-400mA	250V	35A	10,000A	-	1.2	600
GMD-500mA	250V	35A	10,000A	-	1.4	550
GMD-600mA	250V	35A	10,000A	-	3.1	450
GMD-630mA	250V	35A	10,000A	-	3.1	450
GMD-750mA	250V	35A	10,000A	-	4.7	410
GMD-800mA	250V	35A	10,000A	-	6.6	380
GMD-1A	250V	35A	10,000A	-	12	310
GMD-1.2A	250V	100A	10,000A	-	16	280
GMD-1.25A	250V	100A	10,000A	-	16	245
GMD-1.5A	250V	100A	10,000A	-	25	240
GMD-1.6A	250V	100A	10,000A	-	27	220
GMD-2A	250V	100A	10,000A	-	42	200
GMD-2.5A	250V	100A	10,000A	-	94	195
GMD-3A	250V	100A	10,000A	-	145	190
GMD-4A	250V	200A	10,000A	-	300	190

* Interrupting ratings: Interrupting ratings for 125mA - 3A were measured at 70% - 80% power factor on AC. The interrupting ratings for 4A were measured at 100% power factor on AC.

** DC Cold Resistance (Measured at <10% of rated current)

† Typical Pre-Arching I[†] (I[†] was measured at listed interrupting rating and rated voltage)

‡ Maximum Voltage drop (Voltage drop was measured at 20°C ambient temperature at rated current)

TIME CURRENT CURVE

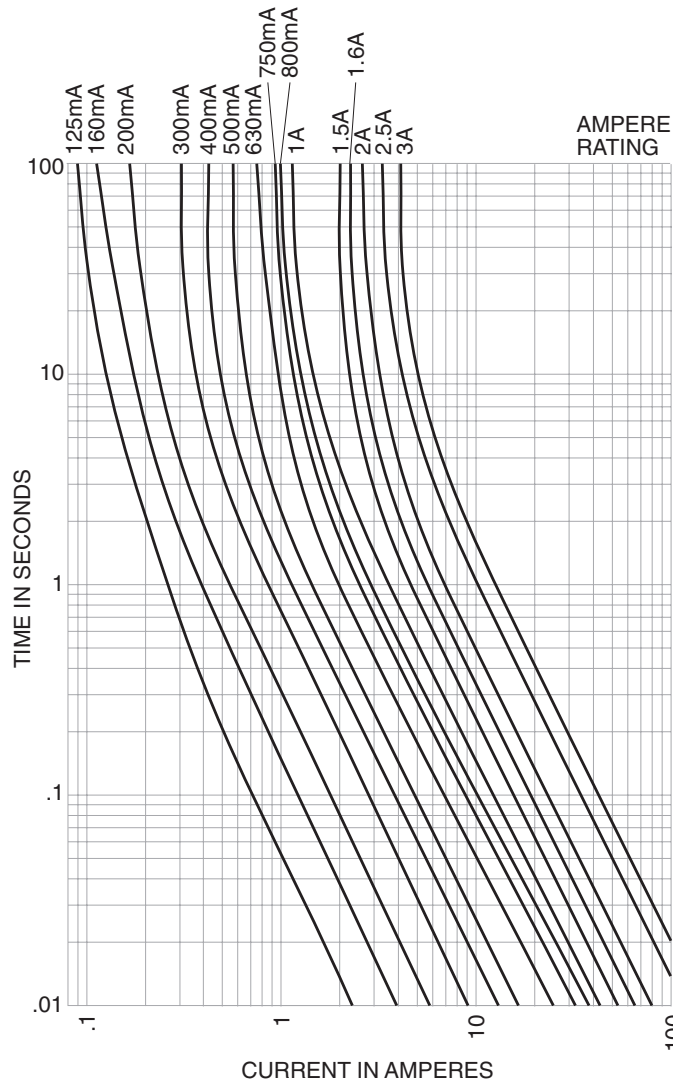

PACKAGING CODE

Packaging Code	Description
BK	100 pieces of fuses packed into a cardboard carton
BK1	1,000 pieces of fuses packed into a poly bag
TR2	1,500 pieces of fuses packed into tape on a reel (19.05mm lead wire length)

OPTION CODE

Option Code	Description
V	Axial leads - copper tinned wire with nickel plated brass overcaps
-R	RoHS compliant version

1/4" x 5/8" Fuses

AGA Series, Fast Acting, Glass Tube

Description

- Fast acting
- 1/4" x 5/8" (6.3mm x 15.9mm) physical size
- Glass tube, nickel-plated brass endcap construction
- Optional leaded version available
- UL Listed product meets standard 248-14

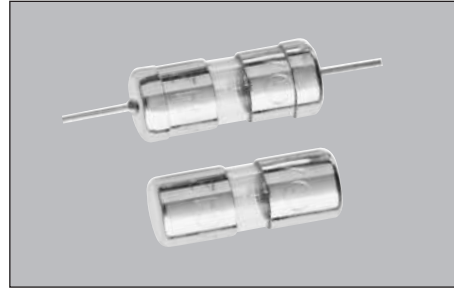

ELECTRICAL CHARACTERISTICS		
Rated Current	% of Amp Rating	Opening Time
1/16 - 10A	100%	4 hours minimum
	135%	60 minutes maximum
	200%	120 seconds maximum

Dimensions mm/(inches)

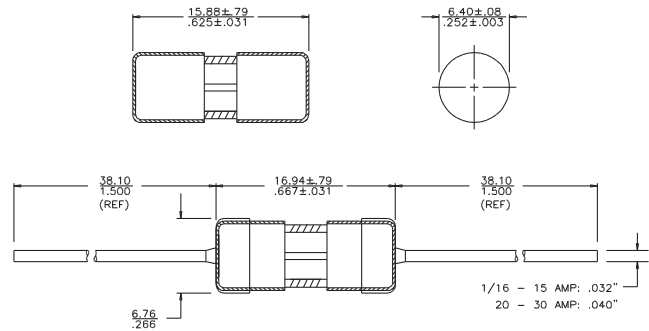

Agency Information

- UL Listed, Guide JDYX, File E19180 (AGA 0-1 1/2A)
- UL Listed, Guide JDYX, File E19180 (AGA-V 0-5A)
- UL Recognized, Guide JDYX2, File E19180 (AGA 2A-12A)
- UL Recognized, Guide JDYX2, File E19180 (AGA-V 6A-12A)

Ordering

- Specify packaging, product, and option code

SPECIFICATIONS

Product Code	Voltage Rating AC	AC Interrupting Rating*		Typical DC Cold Resistance (ohms)**	Typical Melt		Typical Voltage Drop (V)‡
		125V	32V		AC	DC	
AGA-1/16	125 V	10,000A	-	13.250	TBD	-	TBD
AGA-1/10	125 V	10,000A	-	6.250	TBD	-	TBD
AGA-1/8	125 V	10,000A	-	4.000	TBD	-	TBD
AGA-1/4	125 V	10,000A	-	1.740	TBD	-	TBD
AGA-3/8	125 V	10,000A	-	0.925	TBD	-	TBD
AGA-1/2	125 V	10,000A	-	0.300	TBD	-	TBD
AGA-6/10	125 V	10,000A	-	0.250	TBD	-	TBD
AGA-3/4	125 V	10,000A	-	0.179	TBD	-	TBD
AGA-1	125 V	10,000A	-	0.118	TBD	-	TBD
AGA-1-1/2	125 V	10,000A	-	0.077	TBD	-	TBD
AGA-2	125 V	200A	-	0.054	TBD	-	TBD
AGA-2-1/2	125 V	200A	-	0.040	TBD	-	TBD
AGA-3	125 V	200A	-	0.031	TBD	-	TBD
AGA-5	125 V	200A	-	0.017	TBD	-	TBD
AGA-6	32 V	-	1,000A	0.014	TBD	-	TBD
AGA-7	32 V	-	1,000A	0.012	TBD	-	TBD
AGA-7-1/2	32 V	-	1,000A	0.010	TBD	-	TBD
AGA-10	32 V	-	1,000A	0.007	TBD	-	TBD
AGA-15	32 V	-	1,000A	0.005	TBD	-	TBD
AGA-20	32 V	-	1,000A	0.003	TBD	-	TBD
AGA-25	32 V	-	1,000A	0.003	TBD	-	TBD
AGA-30	32 V	-	1,000A	0.002	TBD	-	TBD

* Interrupting Rating: Interrupting ratings for 2A-5A has been measured at 70%-80% power factor. ratings for 5.1A-12A were measured at 80% power factor.

** DC Cold Resistance (Measured at <10% of rated current)

‡ Typical Voltage Drop (Measured at 25°C±3°C ambient temperature at rated current)

TIME CURRENT CURVE

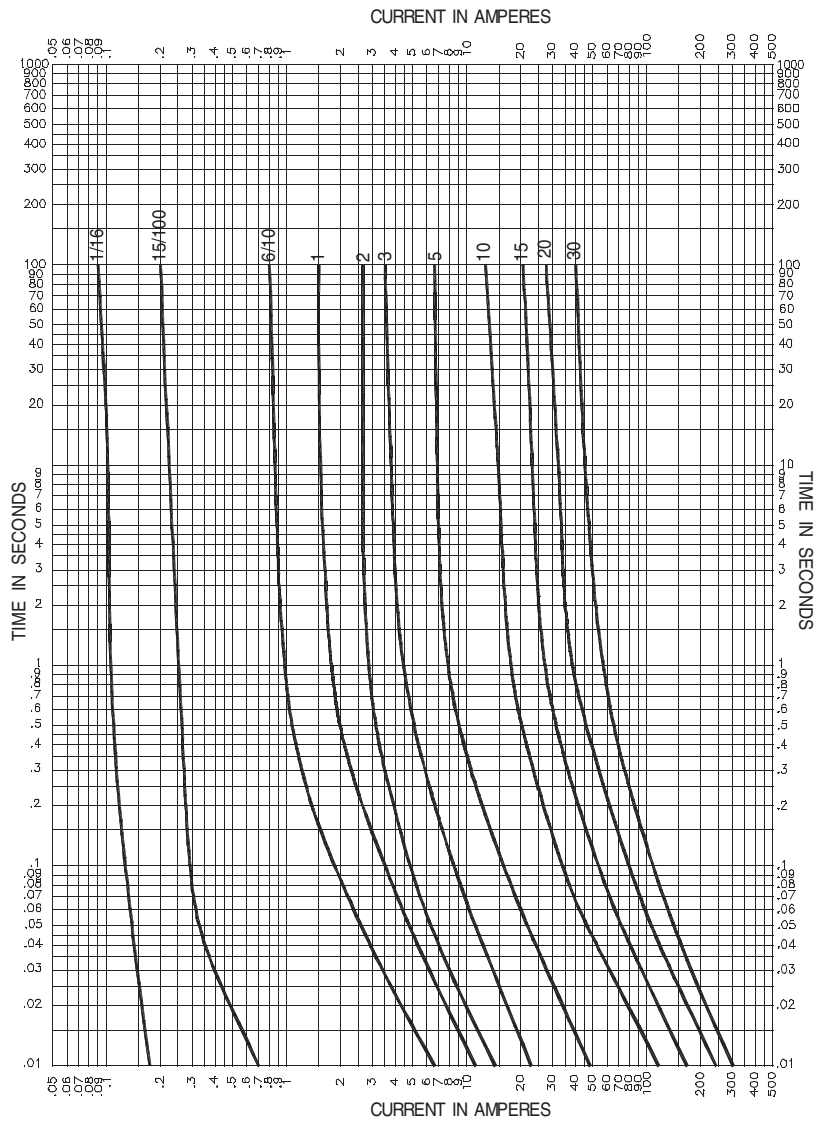

PACKAGING CODE

Packaging Code	Description
BK	100 pieces of fuses packed into a cardboard carton
BK8	8,000 pieces of fuses packed into a cardboard carton

OPTION CODE

Option Code	Description
B	Board Washable - Hermetically sealed to withstand aqueous cleaning
V	Axial leads - copper tinned wire with nickel plated brass overcaps

1/4" x 1" Fuses
AGX Series, Fast Acting, Glass Tube

Description

- Fast acting
- 1/4" x 1 (6.3mm x 25.4mm) physical size
- Glass tube, nickel-plated brass endcap construction
- For instruments, electronic and small appliance circuits
- UL Listed product meets standard 248-14



ELECTRICAL CHARACTERISTICS		
Rated Current	% of Amp Rating	Opening Time
1/500 - 30A	110%	4 hours minimum
	135%	60 minutes maximum
1/500 - 2A	200%	5 seconds maximum
2.5A - 30A	200%	2 minutes maximum

Agency Information

- UL Listed Card: AGX 0-5A (Guide JDYX, File E19180)
- UL Recognized Card: AGX 6-20A (Guide JDYX2, File E19180)
- CSA Component Acceptance Card (Class No. 1422-01, File 53787)

Ordering

- Specify packaging, product, and option code

Dimensions mm/(inches)

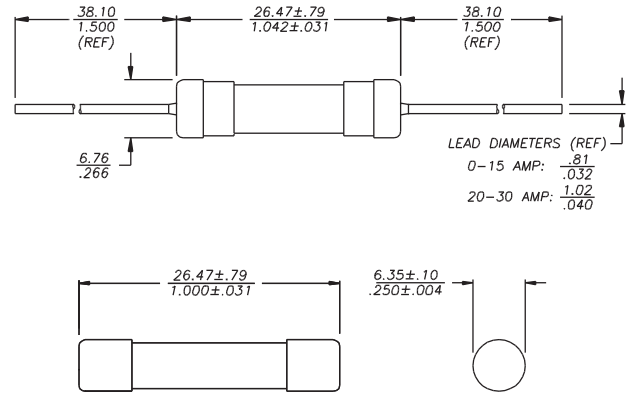

SPECIFICATIONS

Product Code	Voltage Rating AC	Interrupting Rating			Typical DC Cold Resistance (ohms)**
		250VAC	125VAC	32VAC	
AGX-1/500	250V	35A	10,000A	-	1750.00000
AGX-1/200	250V	35A	10,000A	-	285.00000
AGX-1/100	250V	35A	10,000A	-	155.00000
AGX-1/32	250V	35A	10,000A	-	35.00000
AGX-1/16	250V	35A	10,000A	-	22.50000
AGX-1/10	250V	35A	10,000A	-	10.25000
AGX-1/8	250V	35A	10,000A	-	5.41000
AGX-3/16	250V	35A	10,000A	-	3.11500
AGX-2/10	250V	35A	10,000A	-	2.66000
AGX-1/4	250V	35A	10,000A	-	2.79000
AGX-3/10	250V	35A	10,000A	-	1.42500
AGX-3/8	250V	35A	10,000A	-	0.93050
AGX-4/10	250V	35A	10,000A	-	0.89900
AGX-1/2	250V	35A	10,000A	-	0.47850
AGX-3/4	250V	100A	10,000A	-	0.26000
AGX-1	250V	100A	10,000A	-	0.16250
AGX-1-1/4	250V	100A	10,000A	-	0.12750
AGX-1-1/2	250V	100A	10,000A	-	0.09400
AGX-2	250V	100A	10,000A	-	0.06825
AGX-2-1/2	125V	-	10,000A	-	0.04930
AGX-3	125V	-	10,000A	-	0.03825
AGX-4	125V	-	10,000A	-	0.02700
AGX-5	125V	-	10,000A	-	0.02050
AGX-6	125V	-	1,000A	-	0.01475
AGX-7	125V	-	1,000A	-	0.01275
AGX-8	32V	-	-	1,000A	0.01100
AGX-10	32V	-	-	1,000A	0.00867
AGX-15	32V	-	-	1,000A	0.00510
AGX-20	32V	-	-	1,000A	0.00358
AGX-25	32V	-	-	1,000A	0.00275
AGX-30	32V	-	-	1,000A	0.00215

** DC Cold Resistance (Measured at <10% of rated current)

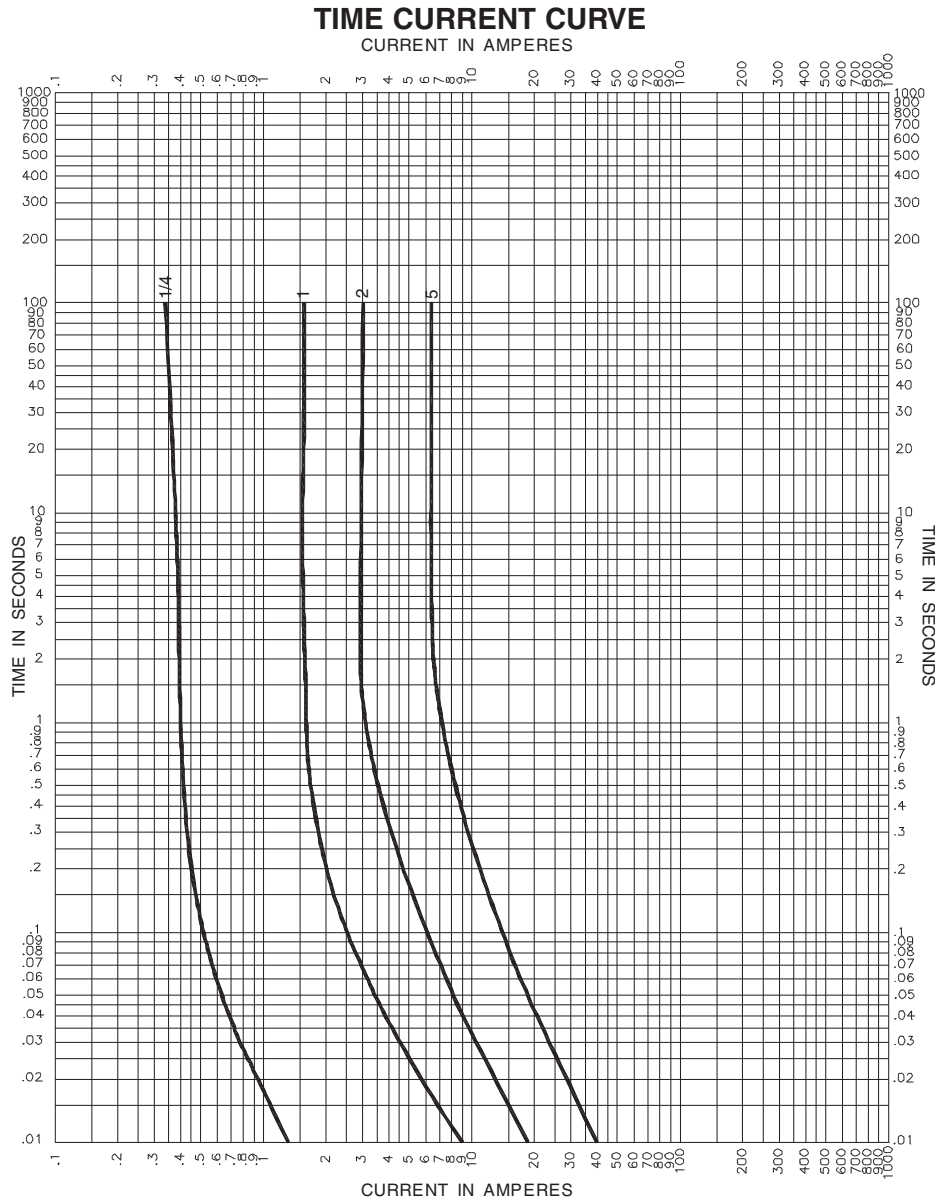

PACKAGING CODE

Packaging Code	Description
BK	100 pieces of fuses packed into a cardboard carton

OPTION CODE

Option Code	Description
B	Board Washable - Hermetically sealed to withstand aqueous cleaning
V	Axial leads - copper tinned wire with nickel plated brass overcaps

Description

TDC10

- Fast Acting
- 1/4" x 1-1/4" physical size
- Glass tube, electroplated brass endcap construction
- Interrupting rating equals 10 times rated current
- Designed to British Standard BS2950A

TDC11

- Time Delay
- 1/4" x 1-1/4" physical size
- Glass tube, electroplated brass endcap construction
- Interrupting rating equals 10 times rated current

Ordering

- Specify packaging and product code

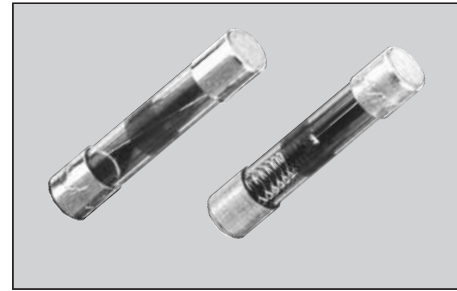

Dimensions mm/(inches)

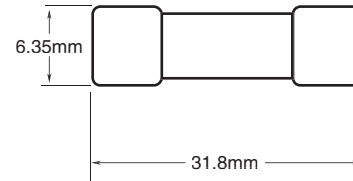

SPECIFICATIONS - TDC10

Product Code	Voltage Rating AC	Interrupting Rating*							
		1000V	750V	500V	350V	250V	150V	100V	32V
TDC10-50MA	1000V	500MA	-	-	-	-	-	-	-
TDC10-60MA	1000V	600MA	-	-	-	-	-	-	-
TDC10-100MA	1000V	1A	-	-	-	-	-	-	-
TDC10-150MA	1000V	1.5A	-	-	-	-	-	-	-
TDC10-250MA	1000V	2.5A	-	-	-	-	-	-	-
TDC10-500MA	750V	-	5A	-	-	-	-	-	-
TDC10-750MA	500V	-	-	7.5A	-	-	-	-	-
TDC10-1A	350V	-	-	-	10A	-	-	-	-
TDC10-1.5A	250V	-	-	-	-	15A	-	-	-
TDC10-2A	250V	-	-	-	-	20A	-	-	-
TDC10-3A	250V	-	-	-	-	30A	-	-	-
TDC10-5A	250V	-	-	-	-	50A	-	-	-
TDC10-7A	150V	-	-	-	-	-	70A	-	-
TDC10-10A	100V	-	-	-	-	-	-	100A	-
TDC10-12A	32V	-	-	-	-	-	-	-	120A
TDC10-15A	32V	-	-	-	-	-	-	-	150A
TDC10-20A	32V	-	-	-	-	-	-	-	200A
TDC10-25A	32V	-	-	-	-	-	-	-	250A

SPECIFICATIONS - TDC11

Product Code	Voltage Rating AC	Interrupting Rating*						
		1000V	750V	500V	350V	250V	150V	100V
TDC11-50MA	1000V	500MA	-	-	-	-	-	-
TDC11-60MA	1000V	600MA	-	-	-	-	-	-
TDC11-100MA	1000V	1A	-	-	-	-	-	-
TDC11-150MA	1000V	1.5A	-	-	-	-	-	-
TDC11-250MA	1000V	2.5A	-	-	-	-	-	-
TDC11-500MA	750V	-	5A	-	-	-	-	-
TDC11-750MA	500V	-	-	7.5A	-	-	-	-
TDC11-1A	350V	-	-	-	10A	-	-	-
TDC11-1.5A	250V	-	-	-	-	15A	-	-
TDC11-2A	250V	-	-	-	-	20A	-	-
TDC11-3A	250V	-	-	-	-	30A	-	-
TDC11-5A	250V	-	-	-	-	50A	-	-
TDC11-7A	150V	-	-	-	-	-	70A	-
TDC11-10A	100V	-	-	-	-	-	-	100A

* Interrupting Rating: Interrupting rating is 10 times the rated current.
** DC Cold Resistance (Measured at <10% of rated current)

TIME CURRENT CURVE

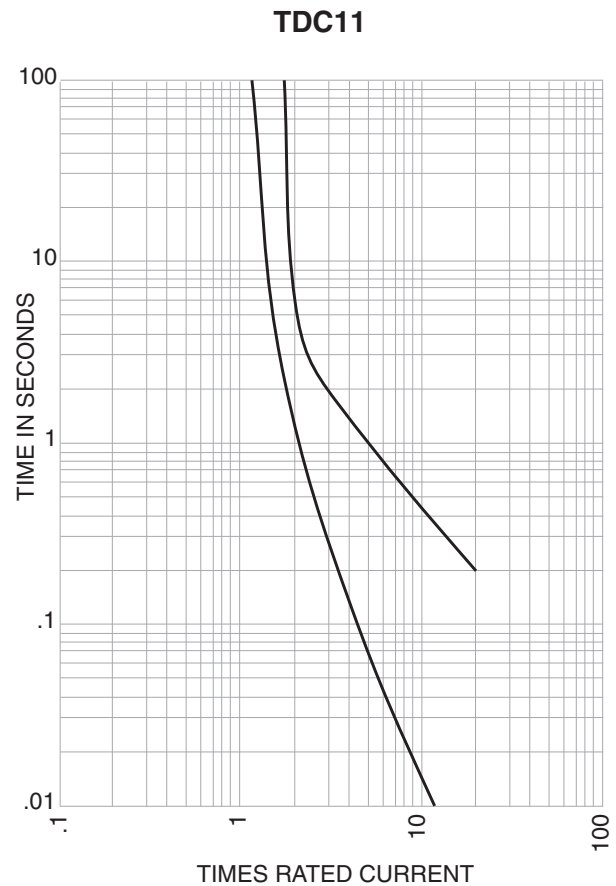
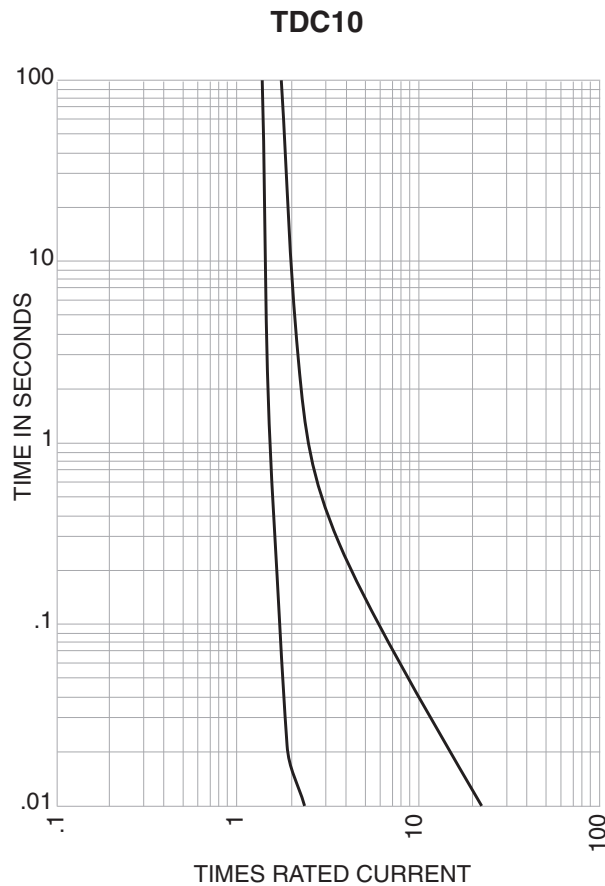

PACKAGING CODE	
Packaging Code	Description
BK	100 pieces of fuses packed into a cardboard carton
BK1	1,000 pieces of fuses packed into a cardboard carton

1/4" x 1-1/4" Fuses

ABC Series, Fast Acting, Ceramic Tube

Description

- Fast-acting, ceramic tube
- Optional axial leads available
- 1/4 x 1-1/4 (6.3mm x 32mm) physical size
- Ceramic tube, nickel-plated brass endcap construction
- UL Listed product meets standard 248-14

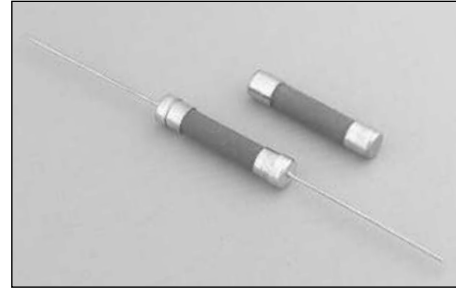

ELECTRICAL CHARACTERISTICS	
% of Amp Rating	Opening Time
100%	4 Hours Minimum
135%	60 Minutes maximum
200%	120 Seconds Maximum

Agency Information

- UL Listed Guide & File numbers (ABC 1/4 - 15A): JDYX & E19180.
- UL Recognition Guide & File numbers (ABC 18 - 30A): JDYX2 & E19180.
- CSA Certification Record No: 053787 C 000 & Class No: 1422 01 & 1422 30.

Environmental Data

- Shock: 1/4A and 1/2A – MIL-STD-202, Method 213, Test Condition I; 1A thru 30A – MIL-STD-202, Method 207, (HI Shock)
- Vibration: 1/4A thru 30A – MIL-STD-202, Method 204, Test Condition C (Except 5g, 500HZ)

Ordering

- Specify packaging, product, and option code

Dimensions (mm/in)

Drawing Not to Scale

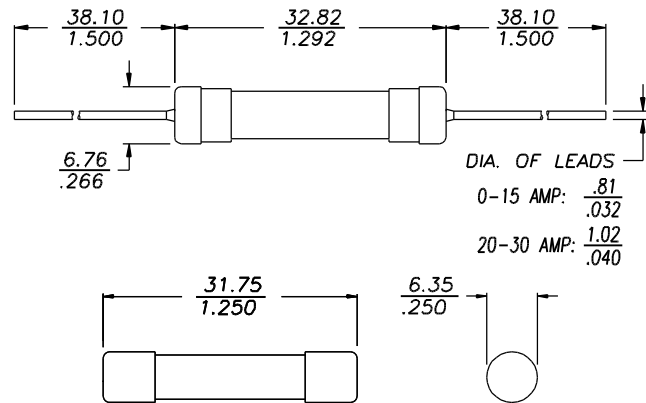

SPECIFICATIONS

Product Code	Voltage Rating		AC Interrupting Rating		DC Interrupting Rating		Typical DC Cold Resistance** (ohms)	Typical Melting I ² t† AC	Typical Voltage Drop‡
	AC	DC	250V	125V	125V	75V			
ABC-1/4	250V	125V	35A	10000A	10000A	-	3.000	0.02	3.25
ABC-1/2	250V	125V	35A	10000A	10000A	-	0.788	0.19	0.51
ABC-3/4	250V	125V	35A	10000A	10000A	-	0.303	0.8	0.42
ABC-1	250V	125V	35A	10000A	10000A	-	0.197	1.4	0.35
ABC-1-1/2	250V	125V	100A	10000A	10000A	-	0.1175	2.9	0.35
ABC-2	250V	125V	100A	10000A	10000A	-	0.0755	4.2	0.25
ABC-2-1/2	250V	125V	100A	10000A	10000A	-	0.05875	8.53	0.26
ABC-3	250V	125V	100A	10000A	10000A	-	0.0435	19.5	0.25
ABC-4	250V	125V	200A	10000A	10000A	-	0.02975	29.1	0.25
ABC-5	250V	125V	200A	10000A	10000A	-	0.0286	16.4	0.23
ABC-6	250V	125V	200A	10000A	10000A	-	0.02315	31.6	0.24
ABC-7	250V	125V	200A	10000A	10000A	-	0.0183	73.2	0.20
ABC-8	250V	125V	200A	10000A	10000A	-	0.0146	111.9	0.17
ABC-10	250V	125V	200A	10000A	10000A	-	0.01205	215.6	0.15
ABC-12	250V	125V	750A	10000A	10000A	-	0.0068	129.6	0.11
ABC-15	250V	125V	750A	10000A	10000A	-	0.005425	200.2	0.12
ABC-20	250V	125V	400A	1000A	10000A	-	0.00366	550.8	0.13
ABC-25	125V	125V	-	1000A	400A	1000A	0.00263	839.3	0.12
ABC-30	125V	125V	-	1000A	400A	1000A	0.002225	1,429	0.14

** DC Cold Resistance (Measured at ≤10% of rated current)

† Typical Melting I²t (A²Sec) (I²t was measured at listed interrupting rating and rated voltage. Measured at 70% to 80% power factor on AC)

‡ Typical Voltage Drop (Voltage drop was measured at 25°C±3°C ambient temperature at rated current)

TIME CURRENT CURVE

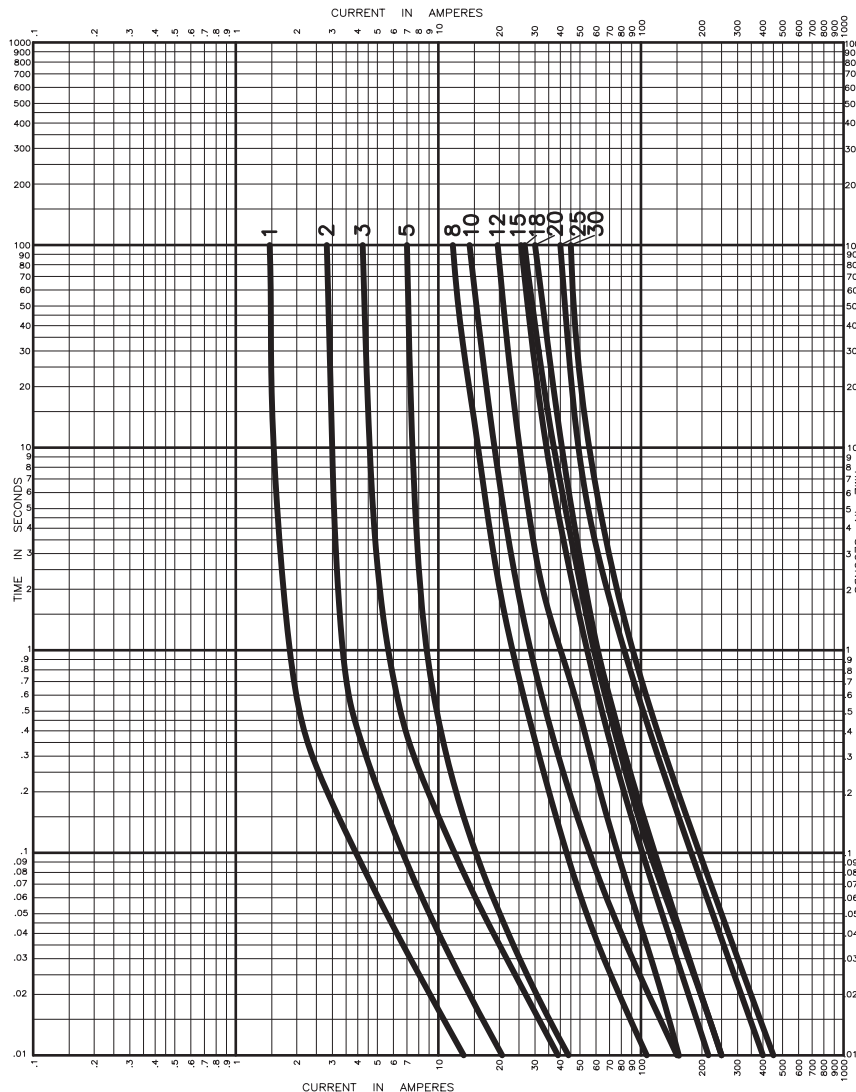

PACKAGING CODE	
Packaging Code	Description
BK	100 pieces of fuses packed into a cardboard carton
BK1	1,000 pieces of fuses packed into a cardboard carton
BK8	8,000 pieces of fuses packed into a cardboard carton

OPTION CODE	
Option Code	Description
B	Board Washable - Hermetically sealed to withstand aqueous cleaning
V	Axial leads - copper tinned wire with nickel plated brass overcaps
-R	RoHS compliant version

1/4" x 1-1/4" Fuses

AGC Series, Fast Acting, Glass Tube

Description

- Fast-acting, glass tube
- Optional axial leads available
- 1/4 x 1-1/4 (6.3mm x 32mm) physical size
- Glass tube, nickel-plated brass endcap construction
- UL Listed product meets standard 248-14

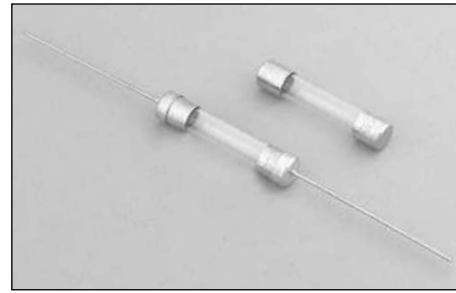

ELECTRICAL CHARACTERISTICS	
% of Amp Rating	Opening Time
100%	None
135%	60 Minutes Maximum
200%	120 Seconds Maximum

Agency Information

- UL Listed Card: AGC 1/500-10
- UL Recognition Card: AGC 11-45
- CSA Component Acceptance Card (Class No. 1422 30)
- CSA Certification Card (Class No. 1422 01)

Environmental Data

- Shock: 1/100A thru 3/4A – MIL-STD-202, Method 213, Test Condition I; 1A thru 30A – MIL-STD-202, Method 207, (HI Shock)
- Vibration: 1/100A thru 30A – MIL-STD-202, Method 204, Test Condition A (Except 5g, 500HZ)

Ordering

- Specify packaging, product, and option code

Dimensions (mm/in)

Drawing Not to Scale

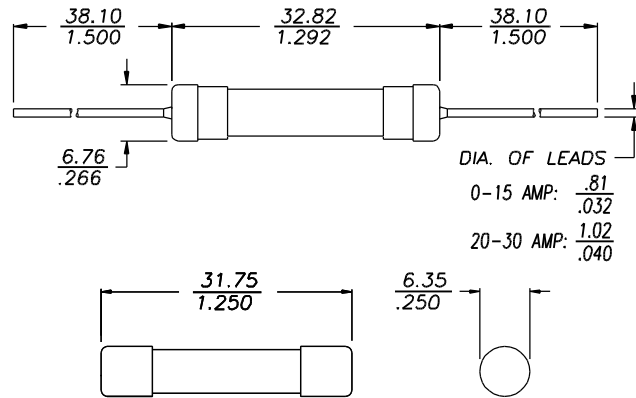

SPECIFICATIONS

Product Code	Voltage Rating AC	AC Interrupting Rating			Typical DC Cold Resistance** (ohms)	Typical Melting I ^{††} AC	Typical Voltage Drop‡
		250V	125V	32V			
AGC-1/20	250V	35A	10000A	-	4.500	0.00773	0.67
AGC-1/16	250V	35A	10000A	-	29.000	0.000181	10.41
AGC-1/10	250V	35A	10000A	-	12.565	0.000787	6.00
AGC-1/8	250V	35A	10000A	-	6.800	0.00131	4.67
AGC-3/16	250V	35A	10000A	-	4.900	0.00637	4.12
AGC-2/10	250V	35A	10000A	-	3.360	0.00435	4.51
AGC-1/4	250V	35A	10000A	-	2.300	0.0148	0.89
AGC-3/10	250V	35A	10000A	-	1.670	0.0208	2.88
AGC-3/8	250V	35A	10000A	-	1.203	0.0321	4.59
AGC-1/2	250V	35A	10000A	-	0.615	0.269	0.59
AGC-3/4	250V	35A	10000A	-	0.312	0.815	0.37
AGC-1	250V	35A	10000A	-	0.190	1.615	0.31
AGC-1-1/4	250V	100A	10000A	-	0.145	0.018	0.35
AGC-1-1/2	250V	100A	10000A	-	0.115	0.0149	0.27
AGC-2	250V	100A	10000A	-	0.078	0.00509	0.28
AGC-2-1/4	250V	100A	10000A	-	0.067	0.00588	0.26
AGC-2-1/2	250V	100A	10000A	-	0.057	0.00879	0.31
AGC-3	250V	100A	10000A	-	0.045	0.0167	0.25
AGC-4	250V	200A	10000A	-	0.030	0.0305	0.22
AGC-5	250V	200A	10000A	-	0.024	0.045	0.23
AGC-6	250V	200A	10000A	-	0.020	0.071	0.23
AGC-7	250V	200A	10000A	-	0.017	0.105	0.23
AGC-7-1/2	250V	200A	10000A	-	0.0146	-	-
AGC-8	250V	200A	10000A	-	0.014	0.152	0.19
AGC-9	250V	200A	10000A	-	0.012	0.21	0.18
AGC-10	250V	200A	10000A	-	0.008	0.492	0.20
AGC-12	32V	-	-	1000A	0.0070	-	-
AGC-14	32V	-	-	1000A	0.0062	-	-
AGC-15	32V	-	-	1000A	0.006	0.566	0.14
AGC-20	32V	-	-	1000A	0.004	1.438	0.12
AGC-25	32V	-	-	1000A	0.003	2.109	0.11
AGC-30	32V	-	-	1000A	0.002	3.807	0.12
AGC-35	32V	-	-	70A	0.0014	-	-
AGC-40	32V	-	-	80A	0.0019	-	-

** DC Cold Resistance (Measured at ≤10% of rated current)

† Typical Melting I^{††} (A²Sec) (I^{††} was measured at listed interrupting rating and rated voltage.)

‡ Typical Voltage Drop (Voltage drop was measured at 25°C ambient temperature at rated current)

TIME CURRENT CURVE

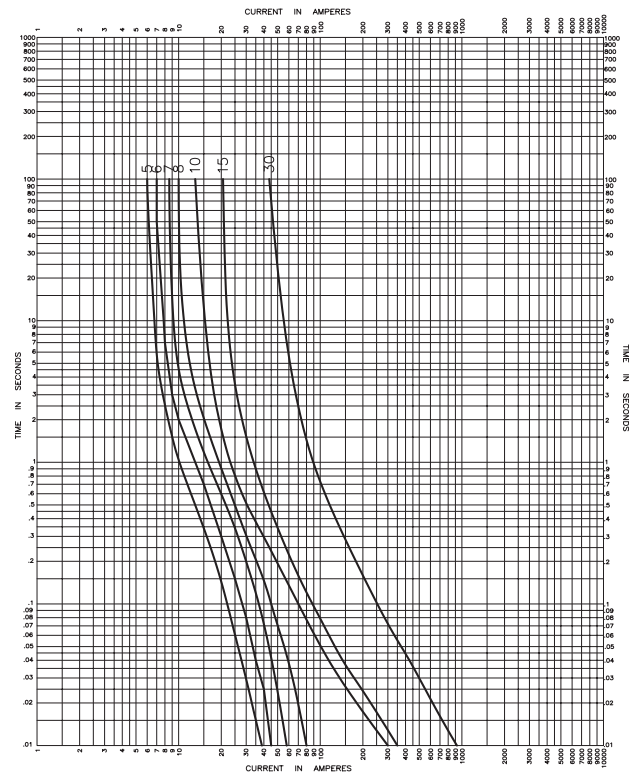
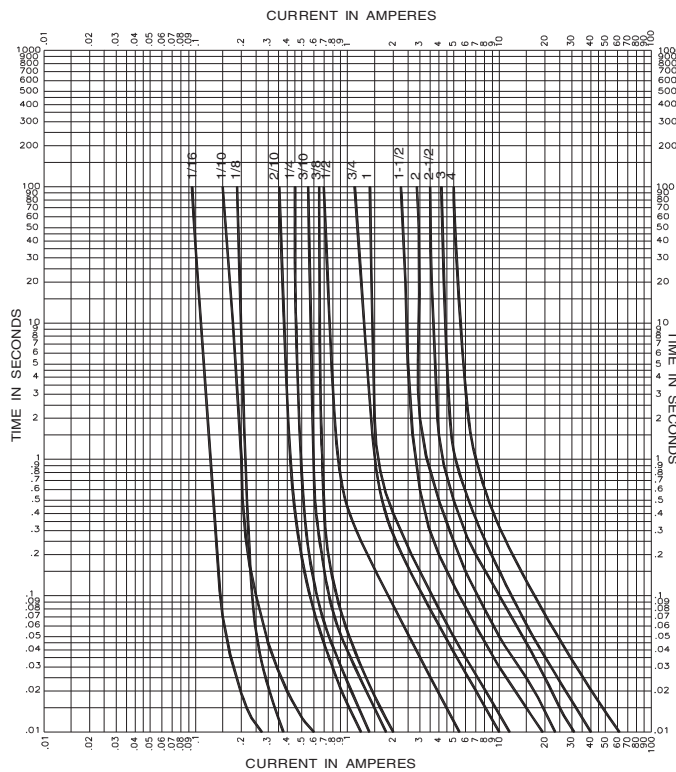

PACKAGING CODE	
Packaging Code	Description
BK	100 pieces of fuses packed into a cardboard carton with flaps folded
BK1	1,000 pieces of fuses packed into a cardboard carton with flaps folded
BK8	8,000 pieces of fuses packed into a cardboard carton with flaps folded

OPTION CODE	
Option Code	Description
B	Board Washable - Hermetically sealed to withstand aqueous cleaning
V	Axial leads - copper tinned wire with nickel plated brass overcaps
-R	RoHS compliant version

1/4" x 1-1/4" Fuses

GBB Series Very Fast Acting, Ceramic Tube

Description

- Very fast-acting
- Optional axial leads available
- 1/4" x 1-1/4" (6.3mm x 32mm) physical size
- Ceramic tube, nickel-plated brass endcap construction
- 100pc-carton quantity weighs 1.0 lb (0.45 kg)
- UL recognized product meets standard 248-14



ELECTRICAL CHARACTERISTICS		
Rated Current	% of Amp Rating	Opening Time
1 - 20A	100%	None
	150%	2 minutes maximum
	250%	1 seconds maximum
	400%	-
25, 30A	100%	None
	150%	2 minutes maximum
	250%	6 seconds maximum
	400%	-

Agency Information

- UL Recognized Card: GBB 1-30A (JFHR2, E56412)
- CSA Component Certified Card (Class 1422-01 File 53787)

Ordering

- Specify packaging, product, and option code

Dimensions mm/(inches)

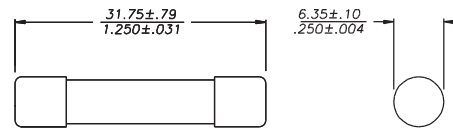
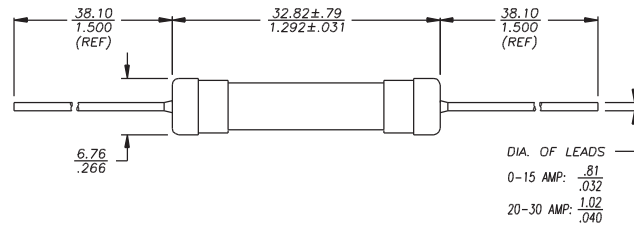

Product Code	Voltage Rating		AC Interrupting Rating*		DC Interrupting Rating*	Typical DC Cold Resistance (ohms)**	Typical Melt I ² t †		Typical Voltage Drop (V)‡
	AC	DC	250V	125V	125V		AC	DC	
	GBB-1	250V	125V	200A	10,000A	10,000A	0.17750	-	-
GBB-1-1/4	250V	125V	200A	10,000A	10,000A	0.17900	-	-	0.17900
GBB-2	250V	125V	200A	10,000A	10,000A	0.06620	-	-	0.07000
GBB-3	250V	125V	200A	10,000A	10,000A	0.04475	-	-	0.04475
GBB-4	250V	125V	200A	10,000A	10,000A	0.03175	-	-	0.03175
GBB-5	250V	125V	200A	10,000A	10,000A	0.02125	-	-	0.02125
GBB-6	250V	125V	200A	10,000A	10,000A	0.01800	-	-	0.01800
GBB-7	250V	125V	200A	10,000A	10,000A	0.01550	-	-	0.01550
GBB-8	250V	125V	200A	10,000A	10,000A	0.01360	-	-	0.01360
GBB-9	250V	125V	200A	10,000A	10,000A	0.01070	-	-	0.01070
GBB-10	250V	125V	200A	10,000A	10,000A	0.00934	-	-	0.00934
GBB-12	250V	125V	200A	10,000A	10,000A	0.00620	-	-	0.08620
GBB-15	250V	125V	200A	10,000A	10,000A	0.00472	-	-	0.00472
GBB-20	250V	125V	200A	200A	200A	0.00330	-	-	0.00365
GBB-25	250V	125V	200A	200A	200A	0.00252	-	-	0.00252
GBB-30	250V	125V	200A	200A	200A	0.00206	-	-	0.00206

* Interrupting ratings: Interrupting ratings for 1-15A at 125Vdc was measured at 10,000A, 3.5 ms maximum, with time constant. Ratings 20-30A at 125Vdc were measured at 200A, 0.5 ms maximum, with time constant. Ratings 1-15A at 125Vac were measured at 10,000A, and 70% - 80% power factor. The interrupting ratings for 1-30A at 250Vac were measured at 90% - 100% power factor.

** DC Cold Resistance (Measured at <10% of rated current)

† Typical Melting I²t (I²t was measured at listed interrupting rating and rated voltage) Interrupting ratings were measured at 70% to 80% power factor on AC.

‡ Typical Voltage drop (Voltage drop was measured at 25°C±3°C ambient temperature at rated current)

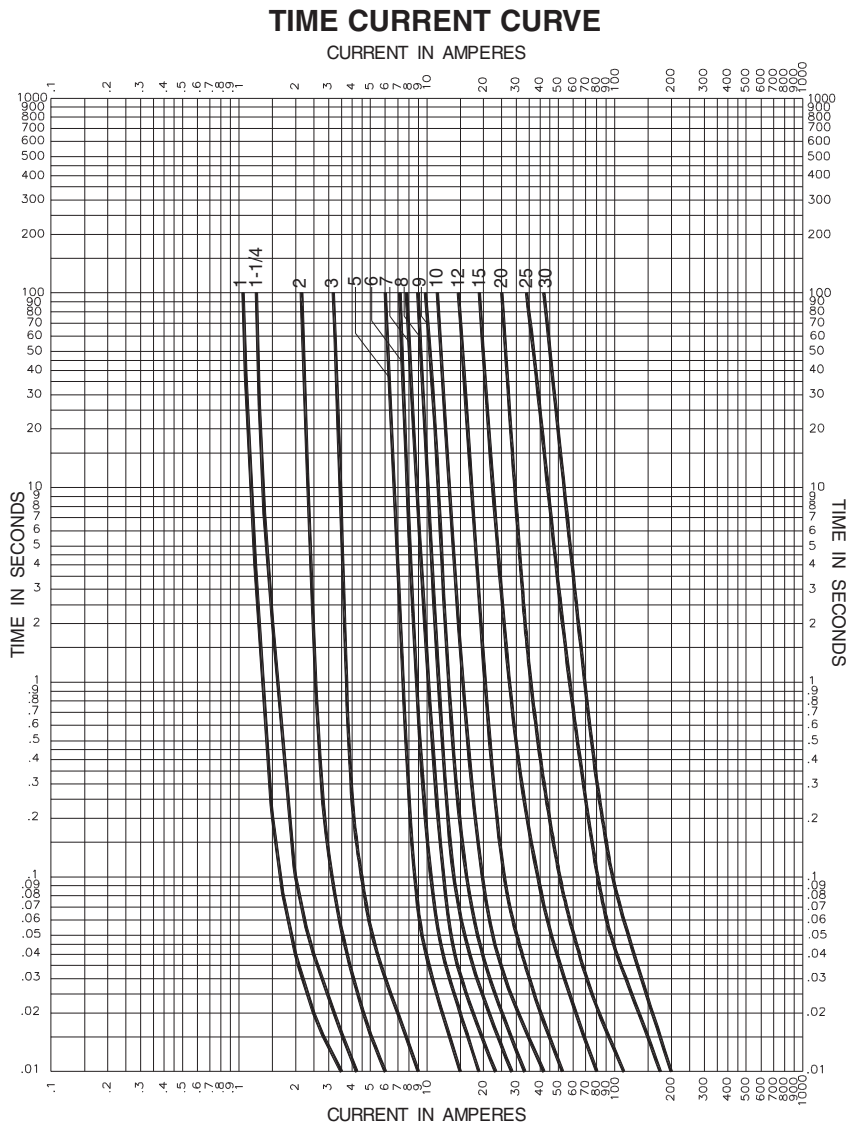

PACKAGING CODE

Packaging Code	Description
BK	100 pieces of fuses packed into a cardboard carton
BK1	1,000 pieces of fuses packed into a cardboard carton

OPTION CODE

Option Code	Description
B	Board Washable - Hermetically sealed to withstand aqueous cleaning
V	Axial leads - copper tinned wire with nickel plated brass overcaps
-R	RoHS compliant version

1/4" x 1-1/4" Fuses

MDA Series, Time Delay, Ceramic Tube

Description

- Time Delay, ceramic tube
- Optional axial leads available
- 1/4 x 1-1/4 (6.3mm x 32mm) physical size
- Ceramic tube, nickel-plated brass endcap construction
- UL Listed product meets standard 248-14

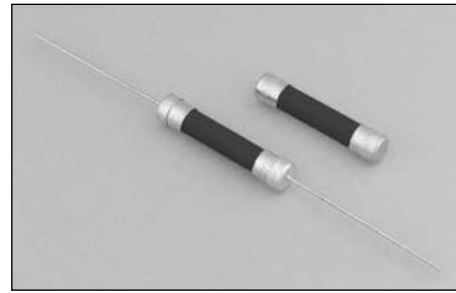

ELECTRICAL CHARACTERISTICS		
Rated Current	Amp Rating	Opening Time
1/4 - 30A	100%	None
	135%	60 Minutes Max.
	200%	120 Seconds Max.

Agency Information

- UL Listed Card: MDA 2/10 - 20A (Guide JDYX, File E19180)
- UL Recognized Card: MDA 25 - 30A (Guide JDYX2, File E19180)
- CSA Certification Card: MDA 2/10 - 20 (Class No. 1422-01)
- CSA Component Acceptance: MDA 25-30A (Class No. 1422-30)

Environmental Data

- Shock: 1/100A and 8/10A – MIL-STD-202, Method 213, Test Condition I; 1A thru 30A – MIL-STD-202, Method 207, (HI Shock)
- Vibration: 1/100A and 8/10A – MIL-STD-202, Method 201; 1/4A thru 30A – MIL-STD-202, Method 204, Test Condition C (Except 5g, 500HZ)

Ordering

- Specify packaging, product, and option code

Dimensions (mm/in)

Drawing Not to Scale

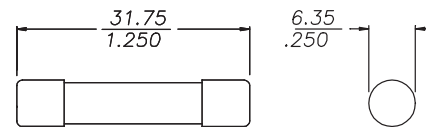
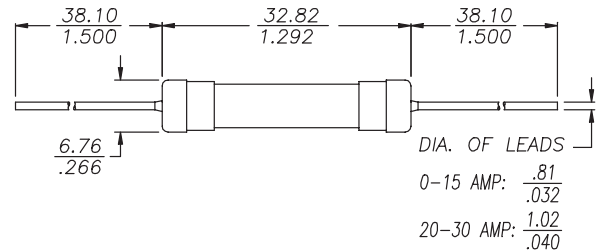

SPECIFICATIONS

Product Code	Voltage Rating		AC Interrupting Rating*		DC Interrupting Rating 125V	Typical DC Cold Resistance** (ohms)	Typical Melting I ^{††} AC	Typical Voltage Drop‡
	AC	DC	250V	125V				
MDA-1/4	250V	-	35A	10000A	-	9.325	0.68	4.00
MDA-1/2	250V	-	35A	10000A	-	1.925	2.3	1.42
MDA-3/4	250V	-	35A	10000A	-	0.8555	7.8	1.31
MDA-1	250V	-	35A	10000A	-	0.560	11.1	1.03
MDA-1-1/2	250V	-	100A	10000A	-	0.2585	25.0	0.691
MDA-2	250V	-	100A	10000A	-	0.1645	64.0	0.623
MDA-2-1/2	250V	-	200A	10000A	-	0.06685	28.9	0.213
MDA-3	250V	-	200A	10000A	-	0.0507	40.9	0.182
MDA-4	250V	-	200A	10000A	-	0.0346	134.0	0.162
MDA-5	250V	-	200A	10000A	-	0.02355	345.9	0.145
MDA-6	250V	-	200A	10000A	-	0.01850	534.3	0.141
MDA-7	250V	-	200A	10000A	-	0.01475	580.3	0.137
MDA-8	250V	-	200A	10000A	-	0.01230	944.0	0.134
MDA-10	250V	-	200A	10000A	-	0.00858	1491.3	N/A
MDA-12	250V	-	750A	10000A	-	0.00725	113.8	0.114
MDA-15	250V	-	750A	10000A	-	0.00543	206.2	0.107
MDA-20	250V	125V	1500A	10000A	10000A	0.00358	439.5	0.095
MDA-25A	250V	125V	1500A	10000A	10000A	0.00309	667.9	0.105
MDA-30A	250V	125V	1500A	10000A	10000A	0.00243	997.0	0.110

* Interrupting Ratings (Measured at 70% - 80% power factor on AC. The interrupting ratings for 25Amp, 30Amp were measured at 90% - 100% power factor on AC)

** DC Cold Resistance (Measured at ≤10% of rated current)

† Typical Melting I^{††} (A²Sec) (I^{††} was measured at listed interrupting rating and rated voltage)

‡ Typical Voltage Drop (Voltage drop was measured at 25°C ambient temperature at rated current)

TIME CURRENT CURVE

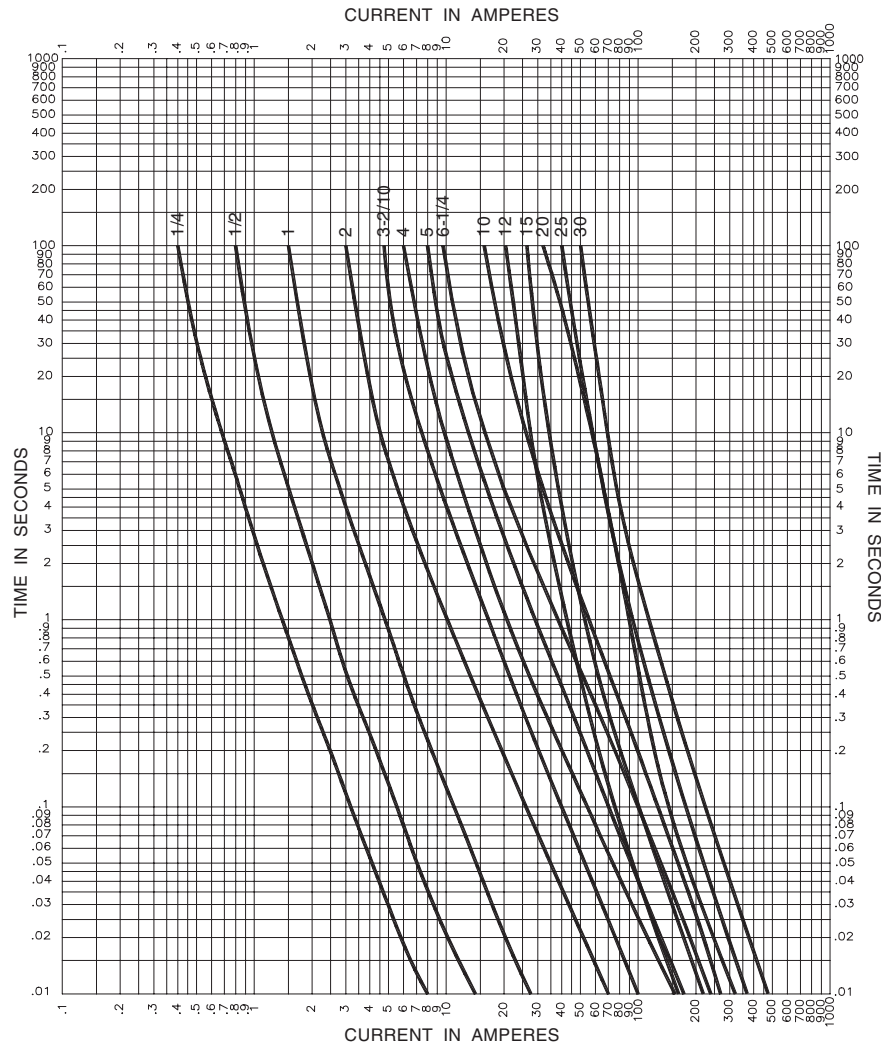

PACKAGING CODE

Packaging Code	Description
BK	100 pieces of fuses packed into a cardboard carton
BK1	1,000 pieces of fuses packed into a cardboard carton
BK8	8,000 pieces of fuses packed into a cardboard carton

OPTION CODE

Option Code	Description
B	Board Washable - Hermetically sealed to withstand aqueous cleaning
V	Axial leads - copper tinned wire with nickel plated brass overcaps
-R	RoHS compliant version

1/4" x 1-1/4" Fuses

MDL Series, Time Delay, Glass Tube

Description

- Time delay, glass tube
- Optional axial leads available
- 1/4 x 1-1/4 (6.3mm x 32mm) physical size
- Glass tube, nickel-plated brass endcap construction
- UL Listed product meets standard 248-14



ELECTRICAL CHARACTERISTICS		
Rated Current	Amp Rating	Opening Time
1/16 - 30A	100%	None
	135%	60 minutes max.
	200%	120 seconds max.
1/16 - 3A	200%	5 seconds min.
3-2/10 - 8A	200%	12 seconds min.

Agency Information

- UL Listed Card: MDL 1/16 - 8A (Guide JDYX, File E19180)
- UL Recognized Card: MDL 9 - 30A (Guide JDYX2, File E19180)
- CSA Certification Card: MDL 1/16 - 8A (Class No. 1422-01)
- CSA Component Acceptance: MDL 9-30A (Class No. 1422-30)

Environmental Data

- Shock: 1/100A and 8/10A – MIL-STD-202, Method 213, Test Condition I; 1A thru 30A – MIL-STD-202, Method 207, (HI Shock)
- Vibration: 1/100A and 8/10A – MIL-STD-202, Method 201; 1/4A thru 30A – MIL-STD-202, Method 204, Test Condition C (Except 5g, 500HZ)

Ordering

- Specify packaging, product, and option code

Dimensions (mm/in)
Drawing Not to Scale

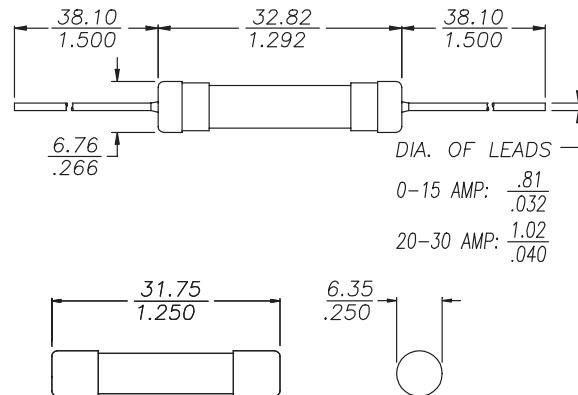

SPECIFICATIONS

Product Code	Voltage Rating AC	AC Interrupting Rating*			Typical DC Cold Resistance** (ohms)	Typical Melting I ² t†† AC	Typical Voltage Drop‡
		250V	125V	32V			
MDL-1/16	250V	35A	10000A	-	38.000	0.0046	2.79
MDL-1/10	250V	35A	10000A	-	15.900	0.0420	1.95
MDL-1/8	250V	35A	10000A	-	9.850	0.0422	1.52
MDL-3/16	250V	35A	10000A	-	4.680	0.116	1.05
MDL-2/10	250V	35A	10000A	-	4.115	0.314	0.972
MDL-1/4	250V	35A	10000A	-	3.200	0.447	0.965
MDL-3/10	250V	35A	10000A	-	2.300	0.412	0.808
MDL-3/8	250V	35A	10000A	-	2.800	0.982	1.46
MDL-1/2	250V	35A	10000A	-	1.725	1.656	1.27
MDL-3/4	250V	35A	10000A	-	0.822	4.343	1.01
MDL-1	250V	35A	10000A	-	0.525	11.498	0.995
MDL-1-1/4	250V	100A	10000A	-	0.320	86.2	0.722
MDL-1-1/2	250V	100A	10000A	-	0.250	22.7	0.721
MDL-2	250V	100A	10000A	-	0.173	62.3	0.644
MDL-2-1/4	250V	100A	10000A	-	0.068	49.6	0.535
MDL-2-1/2	250V	100A	10000A	-	0.096	63.1	0.410
MDL-3	250V	100A	10000A	-	0.067	67.5	0.345
MDL-4	250V	200A	10000A	-	0.035	19.3	0.187
MDL-5	250V	200A	10000A	-	0.023	32.0	0.160
MDL-6	250V	200A	10000A	-	0.018	37.4	0.155
MDL-6-1/4	250V	200A	10000A	-	0.018	38.7	0.152
MDL-7	250V	200A	10000A	-	0.018	42.7	0.140
MDL-8	250V	200A	10000A	-	0.011	47.8	0.119
MDL-9	32V	-	-	1000A	0.009	51.5	0.124
MDL-10	32V	-	-	1000A	0.008	64.4	0.114
MDL-15	32V	-	-	1000A	0.006	354.0	0.130
MDL-20	32V	-	-	1000A	0.002	2914.0	0.530
MDL-25	32V	-	-	1000A	0.001	15221.0	0.30
MDL-30	32V	-	-	1000A	0.001	15581.0	0.40

* Interrupting Ratings (Interrupting ratings were measured at 70% - 80% power factor on AC)

** DC Cold Resistance (Measured at ≤10% of rated current)

† Typical Melting I²t (A²Sec) (I²t was measured at listed interrupting rating and rated voltage.)

‡ Typical Voltage Drop (Voltage drop was measured at 25°C±3°C ambient temperature at rated current)

TIME CURRENT CURVE

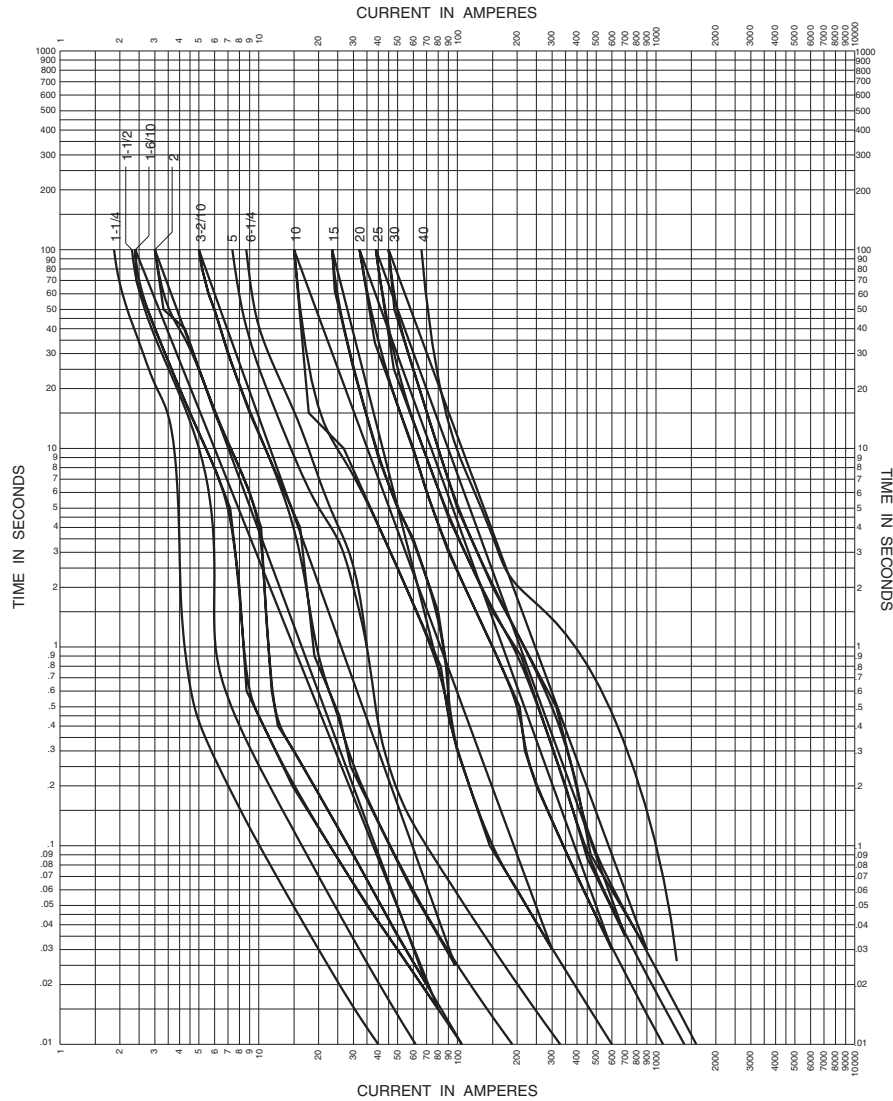

PACKAGING CODE

Packaging Code	Description
BK	100 pieces of fuses packed into a cardboard carton
BK1	1,000 pieces of fuses packed into a cardboard carton
BK8	8,000 pieces of fuses packed into a cardboard carton

OPTION CODE

Option Code	Description
B	Board Washable - Hermetically sealed to withstand aqueous cleaning
V	Axial leads - copper tinned wire with nickel plated brass overcaps
-R	RoHS compliant version

1/4" x 1-1/4" Fuses

MDQ Series Dual Element, Time Delay, Glass Fuse

Description

- Dual element, time delay
- 1/4" x 1-1/4" (6.3mm x 32mm) physical size
- Glass tube, nickel-plated brass endcap construction
- UL Listed product meets standard 248-14



ELECTRICAL CHARACTERISTICS		
Rated Current	% of Amp Rating	Opening Time
1/16A - 30A	100%	None
	135%	60 minutes maximum
	200%	120 seconds maximum

Agency Information

- UL Listed Card: MDQ-1/16 - 7A (Guide JDYX, File E19180)
- UL Recognition Card: MDQ-7.5 - 30A (Guide JDYX2, File E19180)
- CSA Component Acceptance Card: MDQ-1/100 - 30 (Class 1422-01)

Ordering

- Specify packaging, product, and option code

Dimensions mm/(inches)

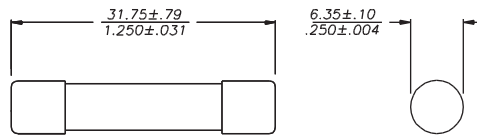
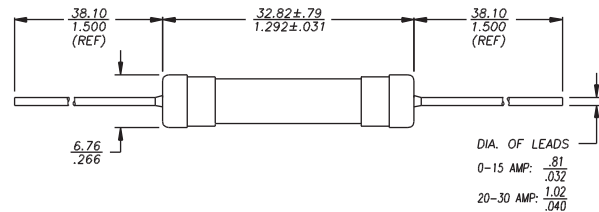

SPECIFICATIONS

Product Code	Voltage Rating AC	Interrupting Rating AC	Typical DC Cold Resistance (ohms)**
MDQ-1/16	250V	35A	83.30000
MDQ-1/10	250V	35A	35.00000
MDQ-1/8	250V	35A	21.50000
MDQ-3/16	250V	35A	10.00000
MDQ-2/10	250V	35A	8.65000
MDQ-1/4	250V	35A	5.77500
MDQ-3/10	250V	35A	4.20000
MDQ-3/8	250V	35A	2.35000
MDQ-1/2	250V	35A	1.40000
MDQ-3/4	250V	35A	0.39685
MDQ-1	250V	35A	0.37400
MDQ-1-1/4	250V	100A	0.36000
MDQ-1-1/2	250V	100A	0.27000
MDQ-2	250V	100A	0.13250
MDQ-2-1/4	250V	100A	0.11450
MDQ-2-1/2	250V	100A	0.10050
MDQ-3	250V	100A	0.05715
MDQ-4	250V	200A	0.03510
MDQ-5	250V	200A	0.02650
MDQ-6	250V	200A	0.01715
MDQ-6-1/4	250V	200A	0.01690
MDQ-7	250V	200A	0.01375
MDQ-8	32V	1,000A	0.01200
MDQ-9	32V	1,000A	0.00888
MDQ-10	32V	1,000A	0.00720
MDQ-15	32V	1,000A	0.00410
MDQ-20	32V	1,000A	0.00150
MDQ-25	32V	1,000A	0.00123
MDQ-30	32V	1,000A	0.00105

** DC Cold Resistance (Measured at <10% of rated current)

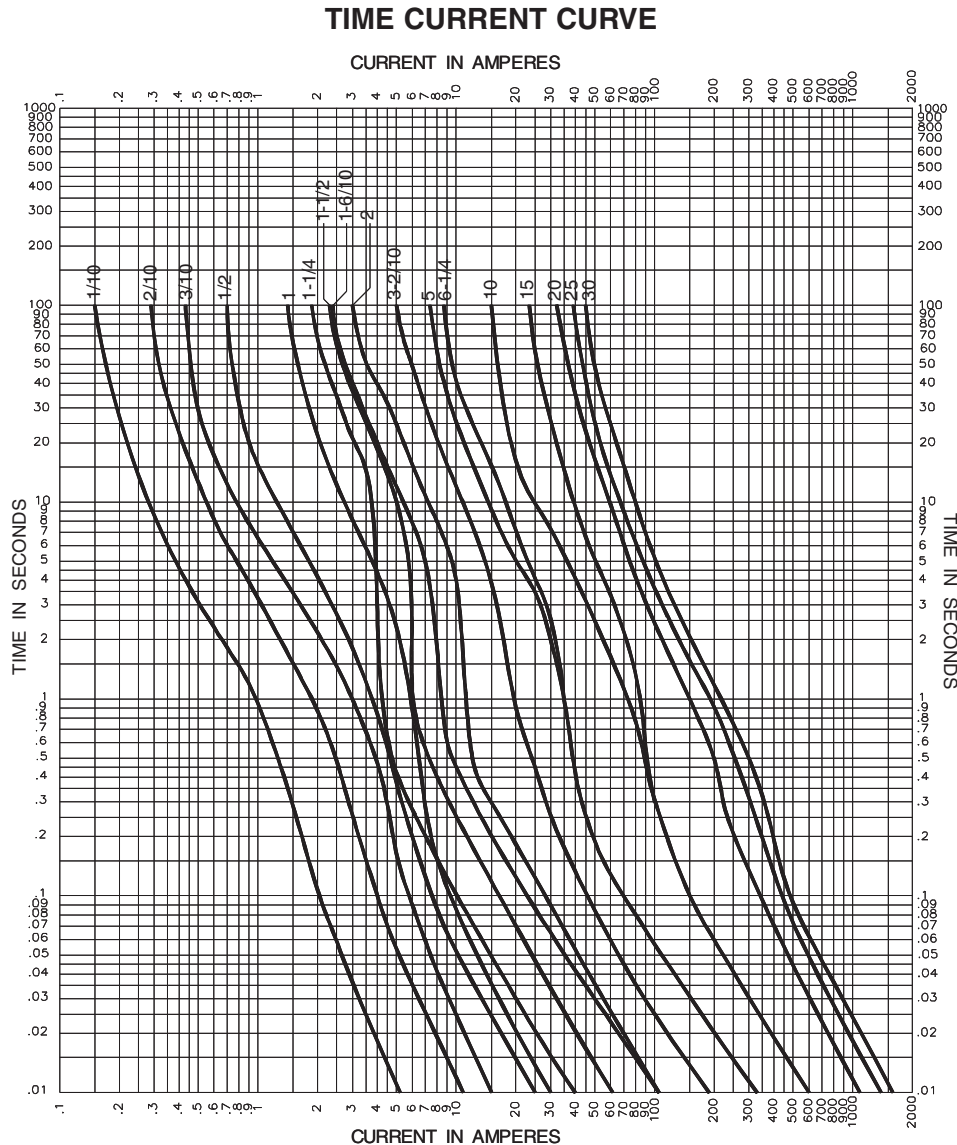

PACKAGING CODE	
Packaging Code	Description
BK	100 pieces of fuses packed into a cardboard carton
BK1	1,000 pieces of fuses packed into a cardboard carton

OPTION CODE	
Option Code	Description
B	Board Washable - Hermetically sealed to withstand aqueous cleaning
V	Axial leads - copper tinned wire with nickel plated brass overcaps

Blade-Type Fuses

ATM Series, Fast Acting

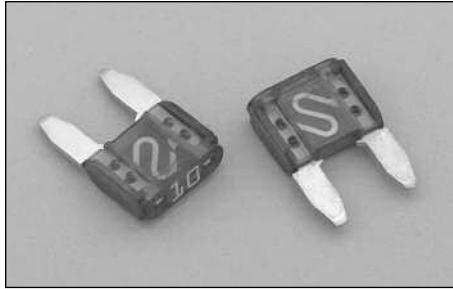

Dimensional Data

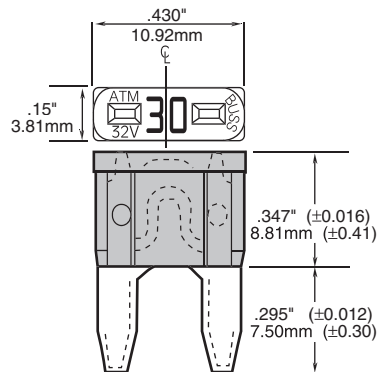

Catalog Symbol: ATM

Fast-Acting

Ampere Ratings: 2 to 30 Amperes

Interrupting Rating: 1,000 Amperes

Ordering: Specify packaging and product code

SPECIFICATIONS

Product Code	Body Color	Voltage Rating DC
ATM-2	Gray	32V
ATM-3	Violet	32V
ATM-4	Pink	32V
ATM-5	Tan	32V
ATM-7 1/2	Brown	32V
ATM-10	Red	32V
ATM-15	Lt. Blue	32V
ATM-20	Yellow	32V
ATM-25	Natural White	32V
ATM-30	Green	32V

Time-Current Characteristic Curves—Average Melt

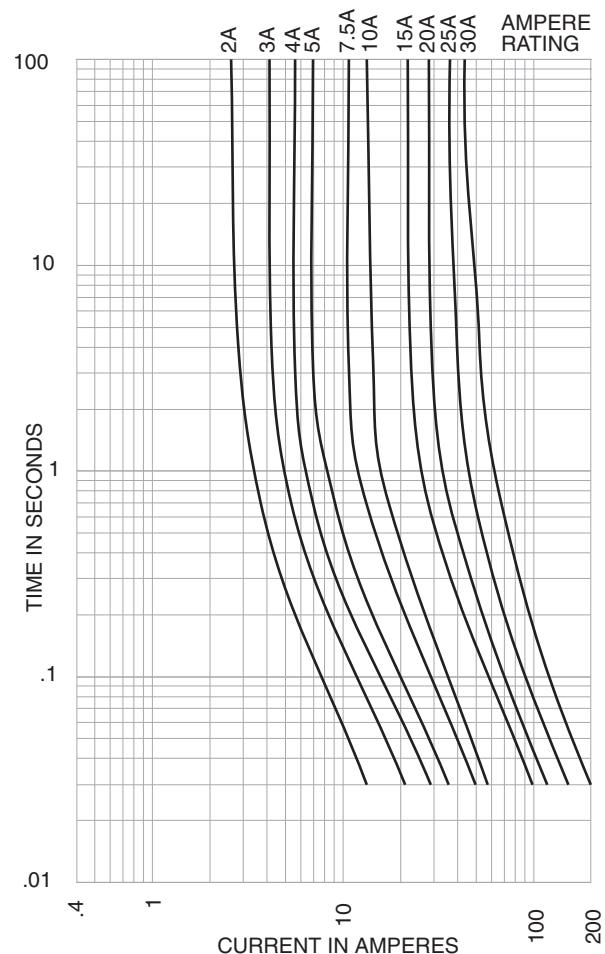

Recommended Bussmann Fuseholders

Blade-Type	Part	Description	Fuse Size	Wire Size
ATM	HHM	Fuseholder w/Cover	3-30 Amps	#12 Lead Wire;
	HHM-B	Body Only		4" Length
	HHM-C	Cover Only	—	—
	HHL	Fuseholder w/Cover	2-20 Amps	#16 Lead Wire;
HHL-B	Body Only	4" Length		

PACKAGING CODE

Packaging Code	Description
Blank	5 pieces of fuses packed in a tin
BK	500 pieces of fuses packed in a carton

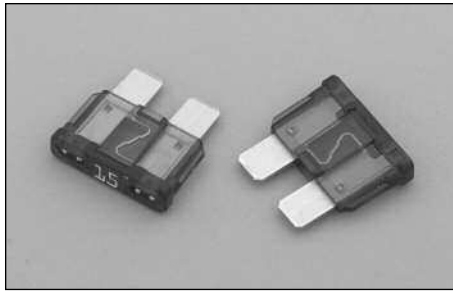

Dimensional Data

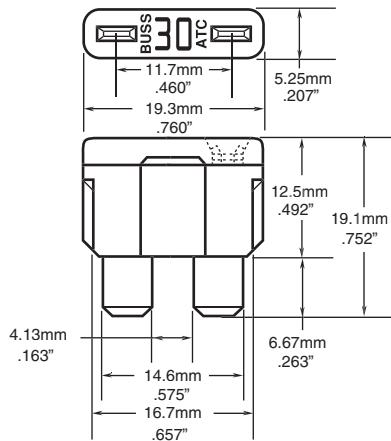

Time-Current Characteristic Curves—Average Melt

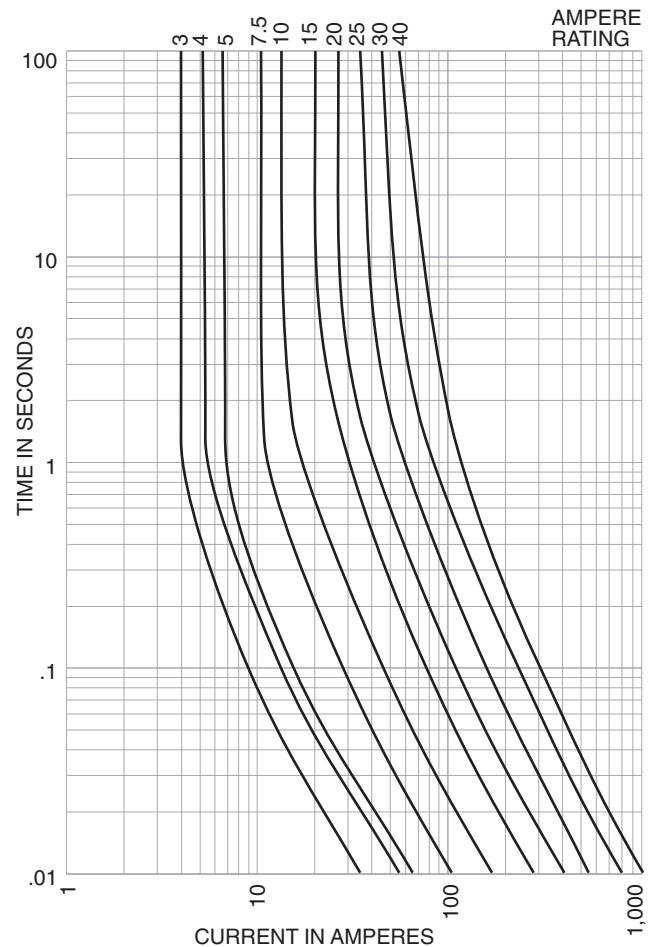

- Catalog Symbol:** ATC
- Fast-Acting**
- Ampere Rating:** 1 to 40 Amperes
- Interrupting Rating:** 1,000 Amperes
- Agency Approvals:** U.L. Recognized, (3-40A)
Guide JFHR2, File E56412
- Ordering:** Specify packaging and product code

SPECIFICATIONS

Product Code	Body Color	Voltage Rating DC
ATC-1	Black	32V
ATC-2	Gray	32V
ATC-3	Violet	32V
ATC-4	Pink	32V
ATC-5	Tan	32V
ATC-7 1/2	Brown	32V
ATC-10	Red	32V
ATC-15	Blue	32V
ATC-20	Yellow	32V
ATC-25	Clear	32V
ATC-30	Green	32V
ATC-40	Amber	32V

Recommended Bussmann Fuseholders*

Blade-Type	Part	Description	Fuse Size	Wire Size
ATC	HHC	Yellow Fuseholder	3-20 Amps	#16 Lead Wire
	HHF	Black Fuseholder w/cover	3-20 Amps	#14 Lead Wire
	HHD	Black Fuseholder	3-30 Amps	#12 Lead Wire
	HHG	Black Fuseholder w/cover	3-30 Amps	#12 Lead Wire
	HHD-C	Cover Only	—	—

*Also used in Bussmann 1A5600 Fuse Clips (0-20A)

PACKAGING CODE

Packaging Code	Description
Blank	5 pieces of fuses packed in a tin
BK	2,000 pieces of fuses packed in a carton

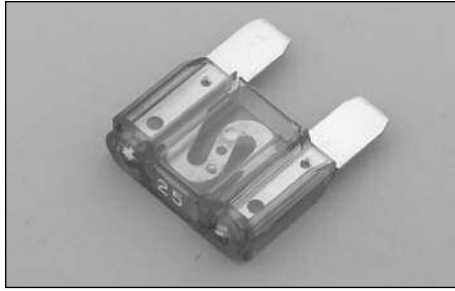

Time-Current Characteristic Curves—Average Melt

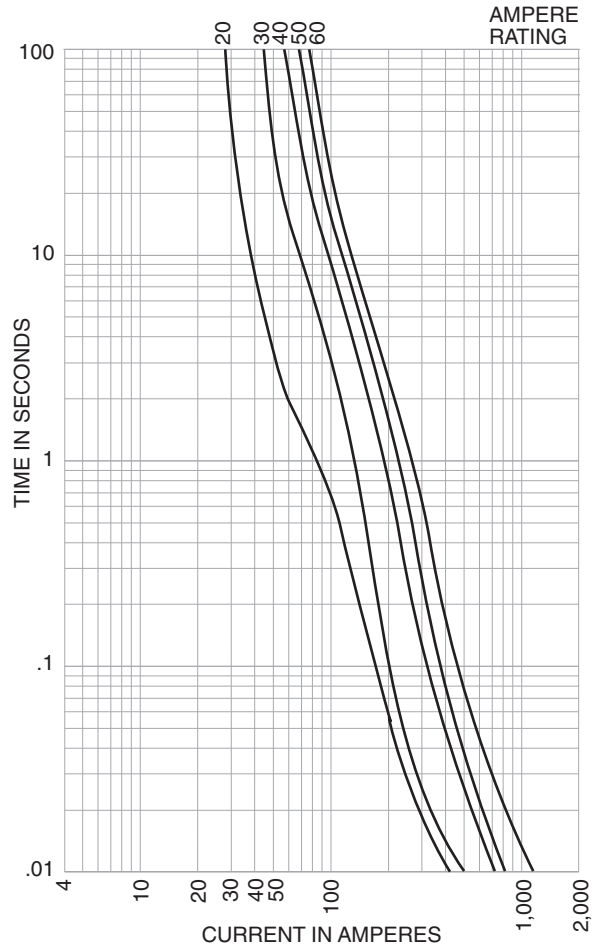

Dimensional Data

All tolerances: ± 0.008 " / -0.005 "
 ± 0.20 mm / -0.13 mm

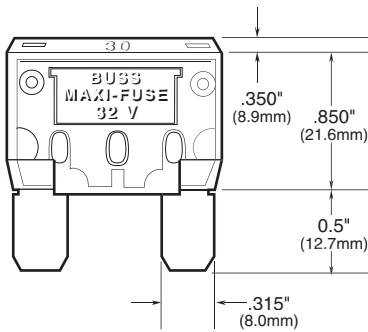

Catalog Symbol: MAX

Fast-Acting

Ampere Rating: 20 to 80 Amperes

Interrupting Rating: 1,000 Amperes

Ordering: Specify packaging and product code

SPECIFICATIONS		
Product Code	Body Color	Voltage Rating DC
MAX-20	Yellow	32V
MAX-30	Green	32V
MAX-40	Orange	32V
MAX-50	Red	32V
MAX-60	Blue	32V
MAX-70	Tan	32V
MAX-80	Natural	32V

Recommended Bussmann Fuseholders

Blade-Type	Part	Description	Fuse Size	Wire Size
MAX	HHX	Fuseholder w/Cover	20-60 Amps	#6 Lead Wire; 5" Length
	HHX-B	Body Only		
	HHX-C	Cover Only	—	—

PACKAGING CODE	
Packaging Code	Description
Blank	1 pieces of fuses packed in a tin
BK	250 pieces of fuses packed in a carton

HTC-15M, HTC-140M

PCB Mounted Fuse Holder & Snap-On Cover

Voltage Rating: 250V, 6.3A, 1.6W

HTC-15M (fuse holder), HTC-140M (natural cover),
HTC-150M* (transparent cover)

*Available in bulk only. Use this format: BK/HTC-150M

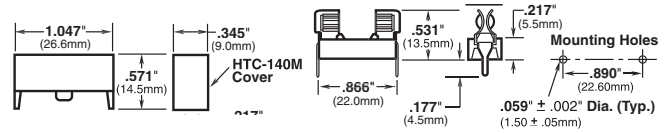

HTC-200M

PCB Mounted Fuseclip

Construction: Tin-plated bronze

Tape and Fan Fold packed

Ammo Pack (AP/HTC-200M) 1000 pieces per box

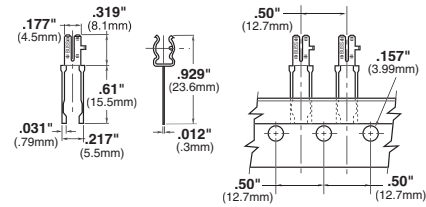

HTC-211M

PCB Mounted Fuseclip with End Stops

Construction: Tin-plated brass

*Equivalent replacement to HTC-210M

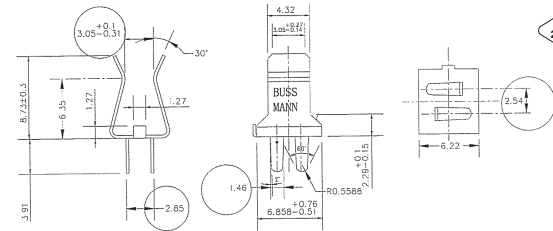

1A3399 Series**

PCB Fuseclips with End Stops & Straight Leads

Catalog Numbers	Clip Material*	Finish
1A3399-01	Beryllium copper*	Silver
1A3399-04	Beryllium copper*	Bright tin
1A3399-10	Spring bronze	Bright tin

*Beryllium copper recommended for amps higher than 15 amps (1/4" clips).

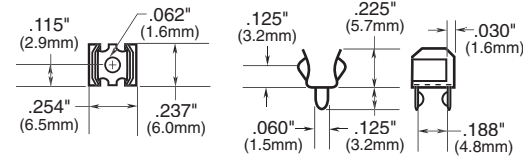

1A5018 Series**

PCB High Profile Fuseclips with End Stops & Straight Leads

Catalog Numbers	Clip Material*	Finish
1A5018-07	Spring bronze	Silver
1A5018-10	Spring bronze	Bright tin

*Beryllium copper recommended for amps higher than 15 amps (1/4" clips).

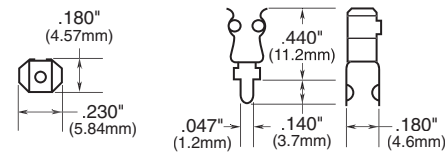

1A5601 Series

PCB Fuseclips (0-7A)

Catalog Number	Clip Material	Finish
1A5601	Cartridge brass	Bright tin

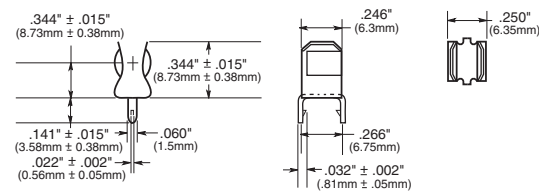

1A5602 Series

PCB Fuseclips (0-7A)

Catalog Number	Clip Material	Finish
1A5602	Cartridge brass	Bright tin

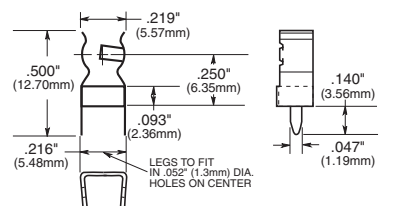

**For RoHS compliant version, add "-R" option code suffix to part number.

Accessories - Fuseclips

PC Board Fuseclips for 1/4" Diameter Fuses

1A3398 Series**

PCB Fuseclips without End Stops or Straight Leads

Catalog Numbers	Clip Material	Finish
1A3398-07	Cartridge brass	Bright tin

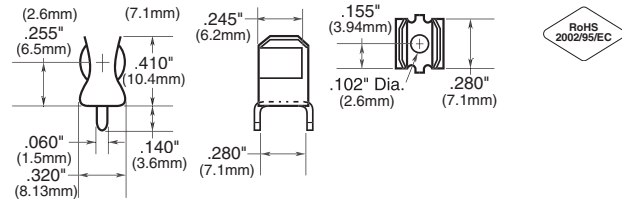

1A1907 Series**

PCB Fuseclips with End Stops & Straight Leads

Catalog Numbers	Clip Material*	Finish
1A1907-02	Cartridge brass	None/bright dipped
1A1907-03	Beryllium copper*	Bright tin
1A1907-05	Beryllium copper*	Silver
1A1907-06	Cartridge brass	Bright tin

*Beryllium copper recommended for amps higher than 15A (1/4" clips).

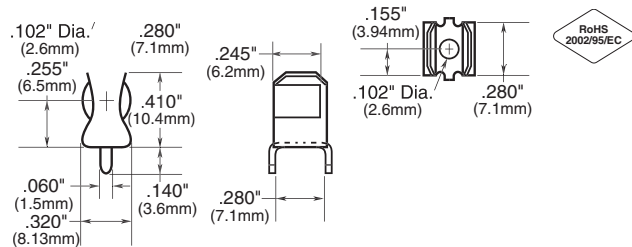

1A4533 Series**

PCB Fuseclips without End Stops or Angled Out Leads

Catalog Numbers	Clip Material*	Finish
1A4533-01	Beryllium copper*	Bright tin
1A4533-06	Cartridge brass	Bright tin

*Beryllium copper recommended for amps higher than 15A (1/4" clips).

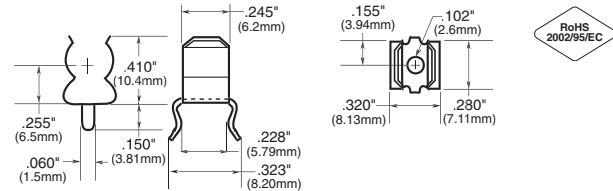

1A4534 Series**

PCB Fuseclips with End Stops & Angled Out Leads

Catalog Numbers	Clip Material*	Finish
1A4534-01	Beryllium copper*	Bright tin
1A4534-06	Cartridge brass	Bright tin

*Beryllium copper recommended for amps higher than 15A (1/4" clips).

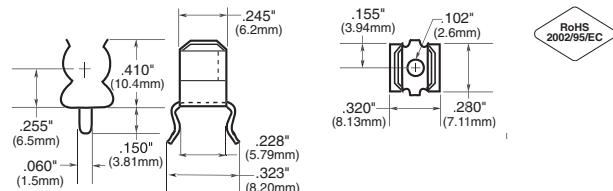

1A1119 Series**

Fuseclips with End Stops & Angled In Leads

Catalog Numbers	Clip Material*	Finish
1A1119-04	Beryllium copper*	Bright tin
1A1119-05	Beryllium copper*	Silver
1A1119-10	Cartridge brass	Bright tin

*Beryllium copper recommended for amps higher than 15A (1/4" clips).

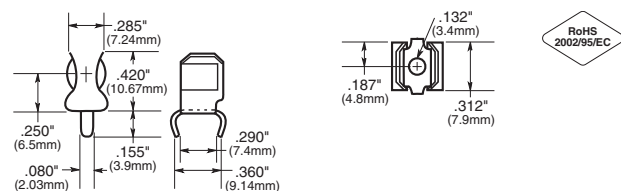

1A1120 Series**

PCB Fuseclips without End Stops or Angled In Leads

Catalog Numbers	Clip Material*	Finish
1A1120-02	Cartridge brass	None/bright dipped
1A1120-05	Beryllium copper*	Silver
1A1120-06	Beryllium copper*	Bright tin
1A1120-09	Cartridge brass	Bright tin

*Beryllium copper recommended for amps higher than 15A (1/4" clips).

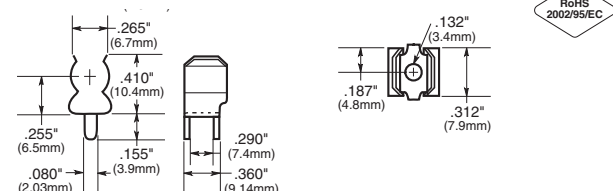

**For RoHS compliant version, add "-R" option code suffix to part number.

Description

- For 5mm x 20mm fuses
- Fuse carriers are interchangeable
- Both vertical and horizontal mounting features
- Fuse carrier and knob are spring loaded bayonet type with screwdriver slot
- Solderability in accordance with IEC 68-2-20
- Shock safety of PC2
- High temperature thermoplastic meets:
 - UL 94-VO
 - Glow wire test: 960°C per IEC 695-2-1

HTC series printed circuit board fuseholders accept 5 x 20mm fuses.

Agency Information

- UL Recognized: IZLT2, E14853A
- CSA Component Certified: Class 6225-01, File 47235

Ordering

- Specify packaging and product code



Dimensions

Drawing Not to Scale

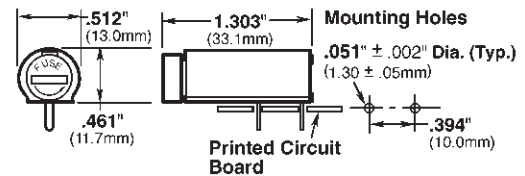
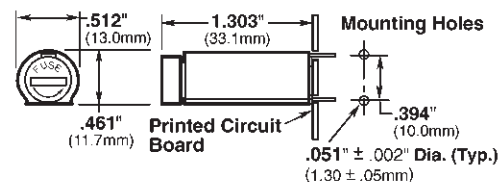

Component	Material
Clip	Tin Plating
Terminals	Copper, Tin Plated
Body	Thermoplastic

SPECIFICATIONS

Product Code	Voltage Rating AC	Current Rating			Ambient Temperature	Temperature Rise	Mounting
		UL	Agency Approval CSA	SEMKO			
HTC-45M	250V	6.3A	6.3A	6.3A	24C	41C	Vertical
HTC-50M	250V	6.3A	6.3A	6.3A	24C	41C	Horizontal

PACKAGING CODE

Packaging Code	Description
Blank	10 pieces of fuseholder packed into a carton
BK	100 pieces of fuseholders packed into a cardboard shelf package

5mm x 20mm Fuseholders

HTC Panel Mount Series

Description

- For 5mm x 20mm fuses
- Tin-plated brass terminals
- Shock safety of PC2
- High temperature Thermoplastic meets:
 - UL 94 VO
 - Glow wire test: 960°C IEC 695-2-1
- Designed to IEC 68-2-20



Agency Information

- UL Recognized: IZLT2, E14853A
- CSA Component Certified: Class 6225-01, File 47235

Ordering

- Specify packaging and product code

SPECIFICATIONS

Product Code	Cap Type	Voltage Rating AC	Current Rating AC	Ambient Temperature	Temperature Rise	Maximum Temperature (C)
HTC-35M	Threaded Cap/Carrier	250V	6.3A	24C	43C	75
HTC-40M	Screwdriver Slot	250V	6.3A	24C	43C	75
HTC-55M	Bayonet Cap/Carrier	250V	6.3A	24C	43C	65
HTC-70M	Bayonet Cap/Carrier	250V	10A	24C	43C	65

Dimensions

Drawing Not to Scale

HTC-35M

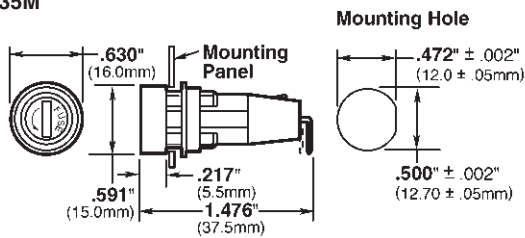

HTC-55M

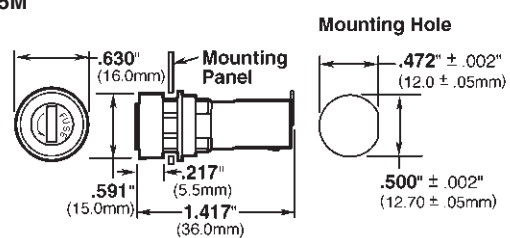

HTC-40M

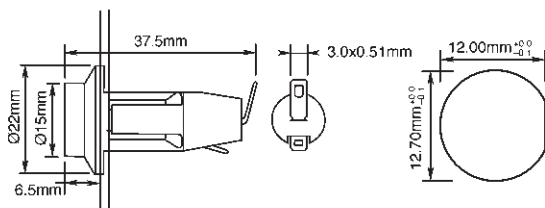

HTC-70M

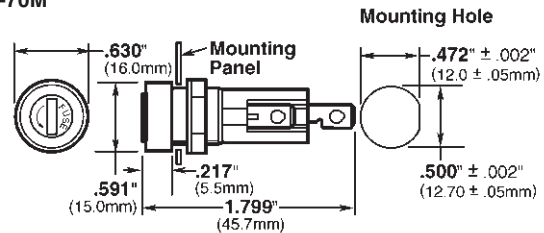

Component	Material
Terminal	Tin-Plated Brass
Body	Thermoplastic
Cap	Thermoplastic
Nut	Polycarbonate

PACKAGING CODE

Packaging Code	Description
Blank	10 pieces of fuseholders packed into a carton
BK	100 pieces of fuseholders packed into a cardboard shelf package

Description

- For 1/4" x 1-1/4" and 5mm x 20mm fuses
- Fuse carriers are interchangeable
- Carriers are color coded for easy identification:
 - Gray for 1/4" fuses
 - Black for 5mm fuses
- Both vertical and horizontal mounting features
- Fuse carrier and knob are spring loaded bayonet type with screwdriver slot
- "Kicked" terminals (all models) for optimum wave-soldering
- Stabilizer pins on HBV model
- High dielectric molded thermoplastic meets UL 94 VO

Resistance Ratings

- Insulation Resistance: 10,000 megaohm at 500Vdc
- Contact Resistance: Less than 0.005 ohms at 200mV

Dielectric Strength

- Dielectric Strength: Over 200mV

Agency Information

- UL Recognized: IZLT2, E14853
- CSA Component Acceptance: Class 6225-01, File 47235

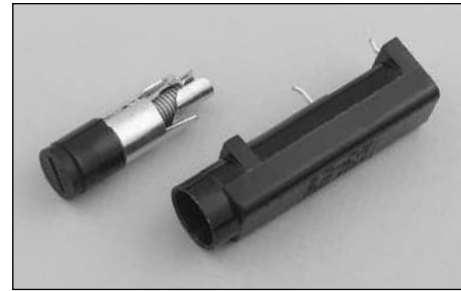

Environmental Data

- Temperature Rating (RTI): The mounting body for all devices has a temperature rating of 150°C. The knob for all devices has a temperature rating of 130°C.

Ordering

- Specify packaging, product, and option code

SPECIFICATIONS

Product Code	Fuseholder			Voltage Rating	Current Rating Agency Approval			
	Body Mount	Carrier Size			UL	CSA	VDE	SEMKO
HBH-I	Horizontal	1/4" x 1-1/4"		250V	16A	12A	6.3A	10A
HBH-M	Horizontal	5mm x 20mm		250V	16A	12A	6.3A	10A
HBV-I	Vertical w/ Stability Pins	1/4" x 1-1/4"		250V	16A	12A	6.3A	10A
HBV-M	Vertical w/ Stability Pins	5mm x 20mm		250V	16A	12A	6.3A	10A
HBW-I	Vertical w/o Stability Pins	1/4" x 1-1/4"		250V	16A	12A	6.3A	10A
HBW-M	Vertical w/o Stability Pins	5mm x 20mm		250V	16A	12A	6.3A	10A
HBH	Horizontal	na		250V	16A	12A	6.3A	10A
HBV	Vertical w/ Stability Pins	na		250V	16A	12A	6.3A	10A
HBW	Vertical w/o Stability Pins	na		250V	16A	12A	6.3A	10A
FBI	na	1/4" x 1-1/4"		250V	16A	12A	6.3A	10A
FBM	na	5mm x 20mm		250V	16A	12A	6.3A	10A

PACKAGING CODE

Packaging Code	Description
Blank	10 pieces of fuseholders packed into a carton
BK	100 pieces of fuseholders packed into a cardboard shelf package

OPTION CODE

Option Code	Description
-R	RoHS compliant version

1/4" x 1-1/4" Fuseholders HKP Panel Mount Series

Description

- For 1/4" x 1-1/4" (6.3mm x 32mm) fuses
- Maximum panel thickness 5/16" (7.9mm) thick
- Bayonet-type Knob
- Vibration Resistant
- Military version is designated FHN26G1
- Plastic nut – BK/1A4287
- Metal nut – BK/1A4806-2
- Cap – 9435-1/2
- Neoprene washer – 9732

Agency Information

- UL Recognized: IZLT2, E14853
- CSA Component Acceptance:
Class 6225-01, File 47235

Ordering

- Specify packaging, product, and option code



Environmental Data

- Temperature rating (RTI): The mounting body for all devices has a temperature rating of 150°C. The knob for these devices are molded plastic with a temperature rating of 150°C.
- Thermoplastic meets UL 94 HB
- Terminal Strength: 5 pounds
- Torque: Mounting – 20 inch-pound
- Salt Spray (corrosion): Test condition B

Dimensions

Drawing Not to Scale

HKP-BBHH, HKP-HH, HKP-LW-HH

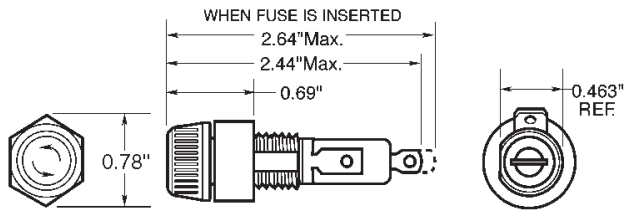

Punched Mounting Hole

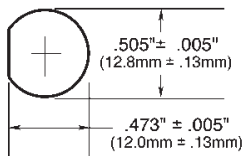

Drilled Mounting Hole

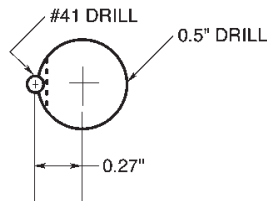

HKP, HKP-L, and HKP-W

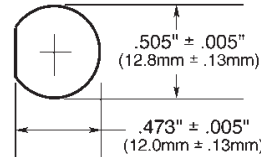
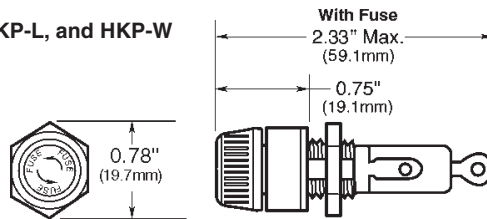

HKP-OO

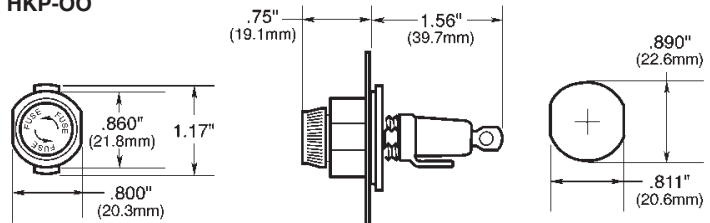

Component	Material
Terminal	Tin-Plated Brass
Body	Thermoset
Cap	Thermoset
Nut	Thermoplastic

SPECIFICATIONS			
Product Code	Feature	Voltage Rating	Current Rating
HKP	Standard	250V	30A
HKP-BBHH	1/4" Quick Connects, nut and washer assembled	250V	20A
HKP-HH	1/4" Quick Connects	250V	20A
HKP-L	2250 stand-off barrier	250V	30A
HKP-LW-HH	Drip-proof knob, 2250V stand-off barrier and 1/4" quick connects	250V	20A
HKP-OO	Snap-lock	250V	30A
HKP-W	Drip-proof knob	250V	30A

PACKAGING CODE	
Packaging Code	Description
Blank	10 pieces of fuseholders packed into a carton
BK	100 pieces of fuseholder components packed separately into a carton

OPTION CODE	
Option Code	Description
-R	RoHS compliant version

Description

- For 1/4" x 1-1/4" and 5mm x 20mm fuses
- All holder bodies have the option of using 1/4" x 1-1/4" or 5mm x 20mm carriers
- Withstands 15 to 20 lbs-in torque to mounting nut when mounting fuseholder to panel
- High temperature, flame retardant, Thermoplastic meets UL 94 VO



SPECIFICATIONS				
Product Code	Current Rating	Voltage Rating	Fuse Size	Quick Connect
HTB-X2I	15A	250V	1/4" x 1-1/4"	3/16"
HTB-X4I	15A	250V	1/4" x 1-1/4"	3/16"
HTB-X6I	20A	250V	1/4" x 1-1/4"	1/4"
HTB-X8I	20A	250V	1/4" x 1-1/4"	1/4"
HTB-X2M	15A	250V	5mm x 20mm	3/16"
HTB-X4M	15A	250V	5mm x 20mm	3/16"
HTB-X6M	16A	250V	5mm x 20mm	1/4"
HTB-X8M	16A	250V	5mm x 20mm	1/4"

Agency Information

- UL Recognized: IZLT2, E14853
- CSA Component Acceptance: Class 6225-01, File 47235
- VDE Certified: 136128, HTB-XXM
- SEMKO Certification: Ref. #0146149/01, HTB-XXM

Maximum Panel Thickness		
Body Type	Inch	Millimeters
HTB-2	0.30	7.62
HTB-3	0.30	7.62
HTB-4	0.125	3.18
HTB-5	0.125	3.18
HTB-6	0.30	7.62
HTB-8	0.125	3.18
HTB-9	0.125	3.18

Replacement Parts

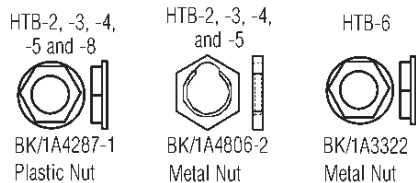

Mounting Dimensions

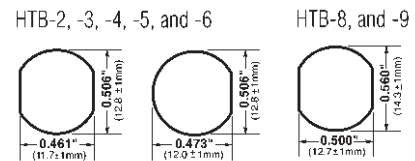

Dimensional Data

Knob Type Carrier	Maximum Panel Thickness	Terminal Options				Carrier Options	
		Solder/ 3/16" Quick-Connect		1/4" Quick-Connect		1/4" x 1 1/4" ("I" Equals Inches)	5mm x 20mm ("M" Equals Metric)
		In-Line	Rt. Angle	In-Line	Rt. Angle	Knob	Knob
Common Dimensional Data: Length (Knob Type) - 1.69" (42.9mm) Plus In-Line Terminal (Screwdriver Slotted) 1.75" (44.5mm) NOTE: Plus In-Line Terminal	0.30" 7.62mm	HTB-22I	HTB-24I	HTB-26I	HTB-28I	✓	—
		HTB-22M	HTB-24M	HTB-26M	HTB-28M	—	✓
Low Profile Rear Hex Nut HTB-2 Dimensions: 0.47" (11.9mm) x 1.125" (28.6mm) x 0.09" NOM. (2.4mm)	0.125" 3.18mm	HTB-42I	HTB-44I	HTB-46I	HTB-48I	✓	—
		HTB-42M	HTB-44M	HTB-46M	HTB-48M	—	✓
High Profile Rear Hex Nut HTB-4 Dimensions: 0.69" (17.5mm) x 0.91" (23.0mm)	0.30" 7.62mm	HTB-62I	HTB-64I	HTB-66I	HTB-68I	✓	—
		HTB-62M	HTB-64M	HTB-66M	HTB-68M	—	✓
Front Hex Nut HTB-6 Dimensions: 0.67" (17.1mm) x 0.92" (23.4mm)	0.125" 3.18mm	HTB-82I	HTB-84I	HTB-86I	HTB-88I	✓	—
		HTB-82M	HTB-84M	HTB-86M	HTB-88M	—	✓
Low Profile Snap-In HTB-8 Dimensions: 0.47" (11.9mm) x 1.125" (28.6mm)							

Fuseholders and fuse carriers may be ordered separately.

Dimensional Data

Knob Type Carrier	Maximum Panel Thickness	Terminal Options				Carrier Options	
		Solder / 3/16" Quick-Connect		1/4" Quick-Connect		1/4" x 1/4" ("I" Equals Inches)	5mm x 20mm ("M" Equals Metric)
		In-Line	Rt. Angle	In-Line	Rt. Angle	Screwdriver	Screwdriver
Common Dimensional Data: Length (Knob Type) - 1.69" (42.9mm) Plus In-Line Terminal (Screwdriver Slotted) 1.75" (44.5mm) NOTE: Plus In-Line Terminal		HTB-32I	HTB-34I	HTB-36I	HTB-38I	✓	—
		HTB-32M	HTB-34M	HTB-36M	HTB-38M	—	✓
		HTB-52I	HTB-54I	HTB-56I	HTB-58I	✓	—
<p>High Profile Rear Hex Nut HTB-5</p>	0.125" 3.18mm	HTB-52M	HTB-54M	HTB-56M	HTB-58M	—	✓
		HTB-92I	HTB-94I	HTB-96I	HTB-98I	✓	—
<p>Low-Profile Snap-In HTB-9</p>	0.125" 3.18mm	HTB-92M	HTB-94M	HTB-96M	HTB-98M	—	✓

Fuseholders and fuse carriers may be ordered separately.

Ordering Information

	HTB-						
Packing (Blank) - Std. BK/ - Bulk	Product Symbol		Fuse Carrier I - 1/4" x 1-1/4" M - 5mm x 20mm	Blash Proof (Optional on -2, -4, -6, and -8)	S	P	FUS CARRIER ONLY
Body Configuration and Mounting Finger Grip Holders 2 - Low Profile (Rear Panel Hex-Nut) 4 - High Profile *6 - (Front Panel Hex-Nut) 8 - Low Profile (Snap-In)			Rear Terminal Configuration 2 - Solder / 3/16" Quick-Connect (In-Line) 4 - Solder / 3/16" Quick-Connect (Right Angle) 6 - 1/4" Quick-Connect (In-Line) 8 - 1/4" Quick-Connect (Right Angle)	-R			Packaging (Blank) - Std. BK/ - Bulk
Screwdriver Slotted Holders 3 - Low Profile 5 - High Profile 9 - Low Profile (Snap-In)				RoHS Compliant Version			Product Symbol FT - Knob Type (For 20, 40, 60, and 80 Series Only) S - Screwdriver Slotted (For 30, 50, and 90 Series Only)
							Fuse Carrier I - 1/4" x 1 1/4" M - 5mm x 20mm

*Profile varies with panel thickness. Holder installs thru rear of panel.

PACKAGING CODE	
Packaging Code	Description
Blank	10 pieces of fuseholders packed into a carton
BK	100 pieces of fuseholders packed into a cardboard shelf package

1/4" x 7/8" to 1-1/4" Fuseholders

HHB In-Line Series

Description

- For 1/4" x 7/8" to 1/4" x 1-1/4" fuses
- Accepts #16 to #12 AWG copper wire
- Simple crimp assembly
- "Snap-Lock" feature provides strong positive union
- High visibility yellow color
- Recommended crimp tools:
 - Thomas & Betts – ERG-2002
 - Channelock No. 909
 - General Electric – U.S. & Metric Electrical Terminal Tool
- UL flammability rating 94 V2

Environmental Data

- Pull Force: 5 pounds minimum to separate fuseholder housing with fuse inside

Ordering

- Specify packaging, product, and option code

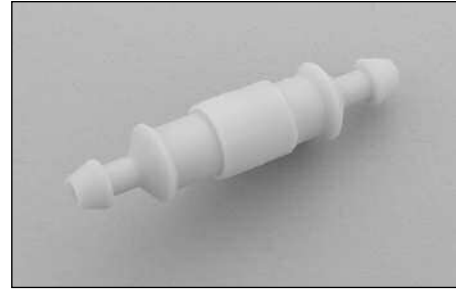

Dimensions

Drawing Not to Scale

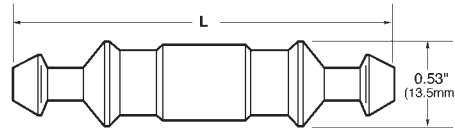

Fuse Length	"L" with fuse installed
7/8"	2.100 Max.
1"	2.250 Max.
1-1/4"	2.420 Max.

SPECIFICATIONS		
Product Code	Voltage Rating AC	Current Rating AC
HHB	32V	30A

Component	Material
Body	Nylon
Crimp	Copper Tin-Plated

PACKAGING CODE	
Packaging Code	Description
Blank	10 pieces of fuseholders packed into a carton
BK	1,000 pieces of fuseholders packed into a cardboard shelf package

OPTION CODE	
Option Code	Description
Y408	#14 AWG insulated wire with 8 inch yellow leads
R408	#14 AWG insulated wire with 8 inch red leads
B408	#14 AWG insulated wire with 8 inch black leads
Y419	#14 AWG insulated wire with 19 inch yellow leads
R419	#14 AWG insulated wire with 19 inch red leads
B419	#14 AWG insulated wire with 19 inch black leads
-R	RoHS Compliant version

Description

- For 1/4" x 1-1/4" (6.35mm x 31.8mm) fuses
- Ideal for harsh environments
 - Water
 - Salt Spray
 - Ultraviolet Light
 - Ozone
 - -40° to 150°C temperature range
 - Withstands many organic solvents and rigorous shock and vibration
- Accepts #18 to #12 AWG copper wire
- High visibility yellow color
- Recommended crimp tools:
 - Thomas & Betts – WT-112M
 - California Terminal Products No. 1250
 - Channelock No. 909
- Replacement contact clip: BK/1A2294
- UL flammability rating 94 HB

Ordering

- Specify packaging, product, and option code



Environmental Data

- Temperature Rating (RTI): 100°C
- Waterproof typically to a depth of 1 foot for 2 hours
- Vibration Resistance: Per MIL STD 810C
- Humidity: 85°C/85% relative humidity for 96 hours
- Brittle Point: Less than -60°C
- Abrasion: 54% NBS index
- Fluid resistance: Type and Class AA, BA, BC, BE, CA, CE per ASTM D-2000 Standard Classification System for rubbers
- Flame Resistance: Pass FMVSS302 and related slow burning when tested in accordance with UL 94HB
- Ozone Resistance: Passed 70 Hours in 50 ppm ozone per ASTM D-5
- Salt Spray: 15% for 166 hours = 0% volume swell
- Xenon Arc Weatherometer

Component	Material
Body	Thermoplastic Rubber
Crimp	Copper Tin-Plated

SPECIFICATIONS		
Product Code	Voltage Rating AC	Current Rating AC
HFB	32V	30A

Time (Hrs)	Tensile Strength (psi)	Elong. (%)	100% Mod. (psi)
0	1100	375	470
500	1130	350	520
1000	1190	350	520

- Heat Aging (% Retention of Mechanical Properties at 125°C)

Parameters	Days				
	1	7	15	30	41.7
Tensile Strength	100	105	115	120	120
% Elongation	90	90	90	90	90
100% Mod.	105	110	120	120	120

PACKAGING CODE	
Packaging Code	Description
Blank	10 pieces of fuseholders packed into a carton
BK	100 pieces of fuseholders packed into a poly bag

OPTION CODE	
Option Code	Description
-R	RoHS compliant version

1/4" x 1-1/4" Fuseholders

HFA In-Line Waterproof Series

Description

- For 1/4" x 1-1/4" (6.35mm x 31.8mm) fuses
- Waterproof for exposed locations
- Accepts #16 to #12 copper wire
- Copper crimp lead material
- Recommended crimp tools:
 - Thomas & Betts – WT-112M
 - Thomas & Betts – ERG-2002
 - Channelock No. 909
- High temperature, flame retardant, phenolic meets UL 94 HB
- Crimp or 1/4" quick connect terminals
- In-line connection



Agency Information

- UL Recognized: (IZLT2, E14853) HFA recognized with use of No. 12 AWG copper conductors secured with Thomas & Betts crimping tool WT-180 or WT-112M
- HFA-HH not UL Recognized

Environmental Data

- Temperature Rating (RTI): 150°C

Ordering

- Specify packaging, product, and option code

Dimensions

Drawing Not to Scale

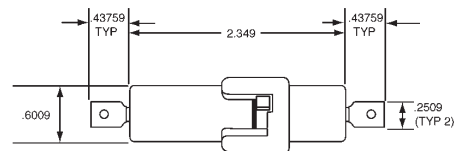
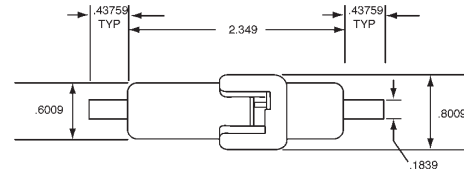

Component	Material
Body	Phenolic
Crimp	Copper, Tin-Plated

SPECIFICATIONS			
Product Code	Voltage Rating	Current Rating	Terminal
HFA	250V	20A	Crimp
HFA-HH	250V	20A	1/4 Quick Connect

PACKAGING CODE	
Packaging Code	Description
Blank	10 pieces of fuseholders packed into a carton
BK	20 pieces of fuseholders packed into a carton

OPTION CODE	
Option Code	Description
-R	RoHS compliant version

Description

- For 1/4" x 7/8" to 1/4" x 1-1/4" fuses
- #14 AWG copper wire leads
- 8" (203mm) leads
- Three springs furnished to accept different fuse lengths
- Wire leads are staked and soldered to the contacts of the fuseholder

Ordering

- Specify packaging, product, and option code



Dimensions

Drawing Not to Scale

SPECIFICATIONS		
Product Code	Voltage Rating	Current Rating
HRK	32V	15A

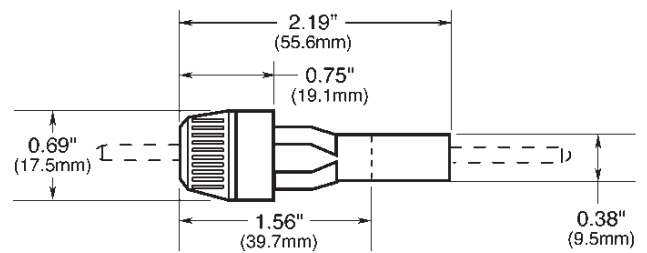

PACKAGING CODE	
Packaging Code	Description
Blank	10 pieces of fuseholder packed into a carton
BK	100 pieces of fuseholder packed into a carton

OPTION CODE	
Option Code	Description
-R	RoHS compliant version

Description

- In-Line Fuseholders for MINI® Fuses.
- Voltage Rating: 32Vdc maximum
- Current Rating: See Table
- Body material withstands high temps. Protective cover has removable straps.



Ordering

- Specify packaging and product code

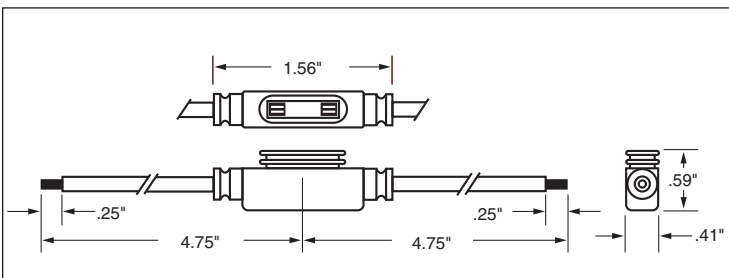

MINI® Fuse Blade Type Holder

Catalog No.	Description	Fuse Size	Electrical Connection	Maximum Continuous Current Rating
HHL	Black fuseholder w/cover	2-20A	#16 black lead wire; 4" length stripped to 1/4"	16A*
HHL-B	Black fuseholder - Body only			
HHM	Black fuseholder w/cover	2-30A	#12 red lead wire; 4" length stripped to 1/4"	24A*
HHM-B	Black fuseholder - Body only			
HHM-C	Black cover only			

Bulk Products (Bulk Quantity - 1000 Pieces)

Catalog No.	Description	Fuse Size	Electrical Connection	Maximum Continuous Current Rating
BK/HHL-R	Black fuseholder - Body only	2-20A	#16 red lead wire; 4" length stripped to 1/4"	16A*

* or 80% of fuse rating, whichever is less

A fuse must be properly and fully inserted into the holder to provide a solid connection. Poor or improper insertion of the fuse can result in failure of the fuse and holder, thus not protecting the device for which it was intended.

PACKAGING CODE	
Packaging Code	Description
BK	1,000 pieces in a box

Description

- In-Line Fuseholders
- Voltage Rating: 32Vdc maximum
- Current Rating: See Table

Ordering

- Specify packaging and product code



Dimensional Data

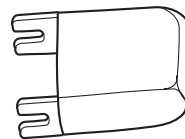
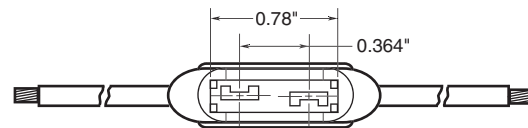
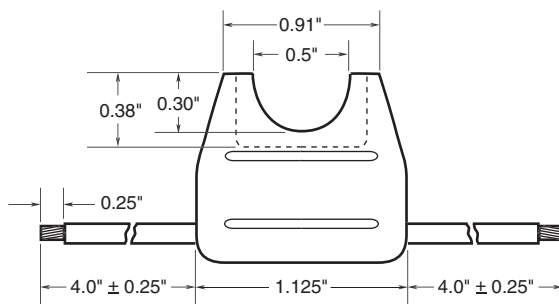

Cover for HHD Fuseholder
Catalog Symbol: HHD-C

Electrical Ratings				
Catalog Code	Description	Fuse Size	Electrical Connection	Maximum Continuous Current Rating
HHC	Yellow fuseholder	3-20A	#16 black leadwire	16A*
HHD	Black fuseholder	3-30A	#12 yellow leadwire	24A*
HHD-C	Cover only	Fits HHD only	Clear polycarbonate	
HHF	Black fuseholder	3-20A	#16 yellow leadwire	16A*
HHG	Black fuseholder w/ cover	3-30A	#12 yellow leadwire	24A*

- * or 80% of fuse rating, whichever is less.
- For ATC® blade-type fuses.
- "Write-in" space for circuit identification on HHC holders (bright yellow)

Bulk Products (Bulk Quantity - 1000 Pieces)				
Catalog Code	Description	Fuse Size	Electrical Connection	Maximum Continuous Current Rating
BK/HHC-R	Yellow fuseholder	3-20A	#16 red leadwire	16A*
BK/HHF-B	Black fuseholder w/ cover	3-20A	#16 black leadwire	16A*

* or 80% of fuse rating, whichever is less.

A fuse must be properly and fully inserted into the holder to provide a solid connection. Poor or improper insertion of the fuse can result in failure of the fuse and holder, thus not protecting the device for which it was intended.

PACKAGING CODE	
Packaging Code	Description
BK	1,000 pieces in a box

Description

- In-Line Fuseholders for MAXI® Fuses.
- Voltage Rating: 32Vdc maximum
- Current Rating: See Table
- Firewall mounting hole permits two or more holders to be mounted together. Cover comes with a removable strap.



Ordering

- Specify packaging and product code

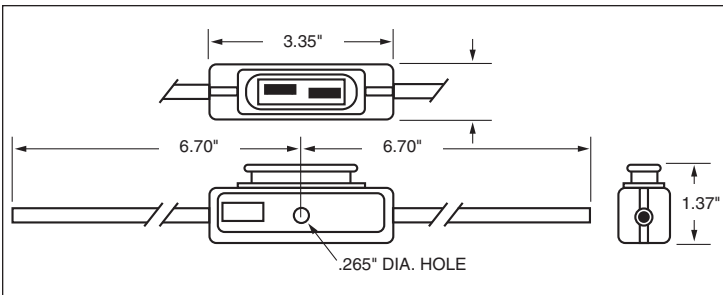

MAXI® Fuse Blade Type Holder				
Catalog Code	Description	Fuse Size	Electrical Connection	Maximum Continuous Current Rating
HHX	Black fuseholder w/cover	20-60A	#6 red lead wire;	48A*
HHX-B	Black fuseholder - Body only		5" length with blunt ends	
HHX-C	Black cover only			

* or 80% of fuse rating, whichever is less

A fuse must be properly and fully inserted into the holder to provide a solid connection. Poor or improper insertion of the fuse can result in failure of the fuse and holder, thus not protecting the device for which it was intended.

Accessories - Fuseholders

PACKAGING CODE	
Packaging Code	Description
BK	100 pieces in a box

Description

- For 5 x 20mm fuses
- With snap-on cover
 - BK/HTC-150M (Transparent Cover)
- Tight cluster mounting
- Clips made of nickel-tin plated spring-bronze
- Available only in bulk of 100 and 1,000 pieces
- High temperature thermoplastic meets:
 - UL 94-VO
 - Glow wire test: 960°C per IEC 695-2-1

Environmental Data

- Maximum suitable temperature: 110°C
- MSL Level 1 (conditions ≤ 30°C / 85% RH)

Ordering

- Specify packaging and product code

SPECIFICATIONS			
Catalog Number	Voltage Rating AC	Current Rating AC	Watts
HTC-15M	250V	6.3A	1.6W

Agency Information

- UL Recognized: IZLT2, E14853
- SEMKO Certificate: 204805
- VDE Certificate: 40004439

Dimensions - in (mm)

HTC-150M Fuse Block with Cover

Drawing Not to Scale

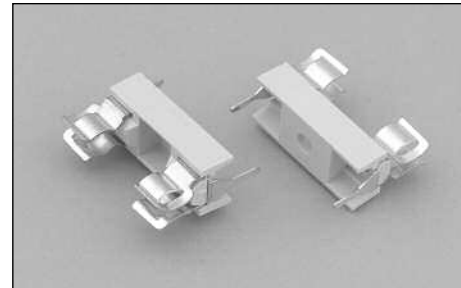
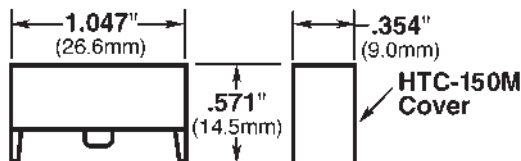

Mounting Holes

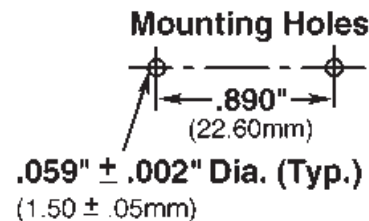

Dimensions - in (mm)

HTC-15M Fuse Block Only

Drawing Not to Scale

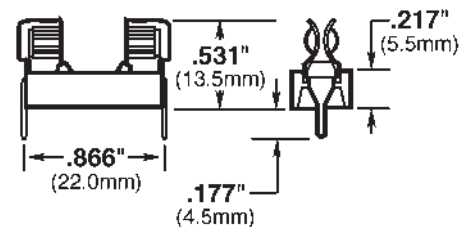

Component	Material
Clip	Spring-Bronze, Bright Tin Plate
Body	Thermoplastic

PACKAGING CODE

Packaging Code	Description
BK	100 pieces of fuse blocks packed into a cardboard shelf package
BK1	1,000 pieces of fuse blocks packed into a carton

Description

- For 1/4" x 1-1/4" (6.3mm x 32mm) fuses
- Bolt-in and snap-in mounting available
- Tight cluster mounting
- All types of terminal configurations
- Clips made of spring-bronze
- Anti-rotational pin provided
- Flame retardant thermoplastic meets UL 94 VO

Environmental Data

- Temperature Rating (RTI): The mounting body for all devices (except those with Suffix -1-SNP or -W-SNP), has a temperature rating of 130°C. The mounting body for all devices with Suffix -1-SNP has a temperature rating of 110°C.

Agency Information

- UL Recognized: E14853
- CSA Certified: 47235

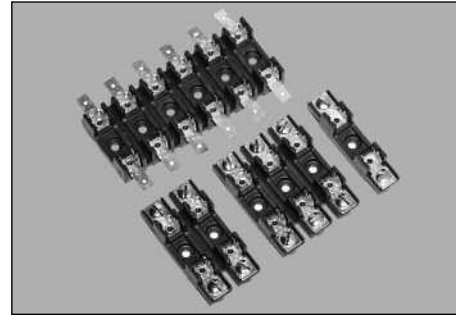

Multiple Pole

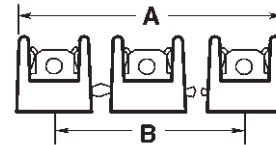

SPECIFICATIONS		
	Voltage Rating AC	Voltage Rating DC
S-8000	300V	300V
S-8100	300V	300V
S-8200	300V	300V
S-8300	300V	300V

No. of Poles	Inches		Millimeters	
	A	B	A	B
1	*	*	*	*
2	1 1/8"	5/8"	28.6	15.9
3	1 3/4"	1 1/4"	44.4	31.8
4	2 3/8"	1 7/8"	60.3	47.6
5	3"	2 1/2"	76.2	63.5
6	3 5/8"	3 1/8"	92.1	79.4
7	4 1/4"	3 3/4"	108	95.2
8	4 7/8"	4 3/8"	123.8	111.1
9	5 1/2"	5"	139.7	127.0
10	6 1/8"	5 5/8"	155.6	142.9
11	6 3/4"	6 1/4"	171.4	158.8
12	7 3/8"	6 7/8"	187.3	174.6

Dimensions

S-8000 Single Pole Bolt-In Mounting Series

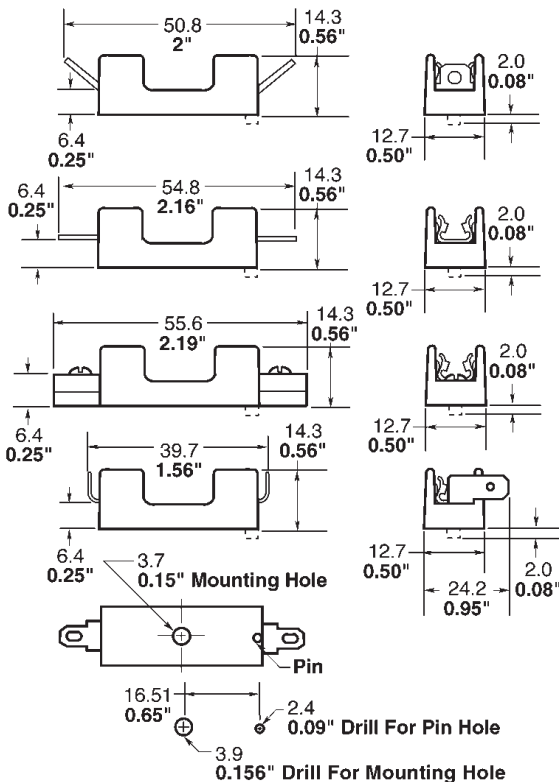

S-8000 Single Pole Snap-In Mounting Series

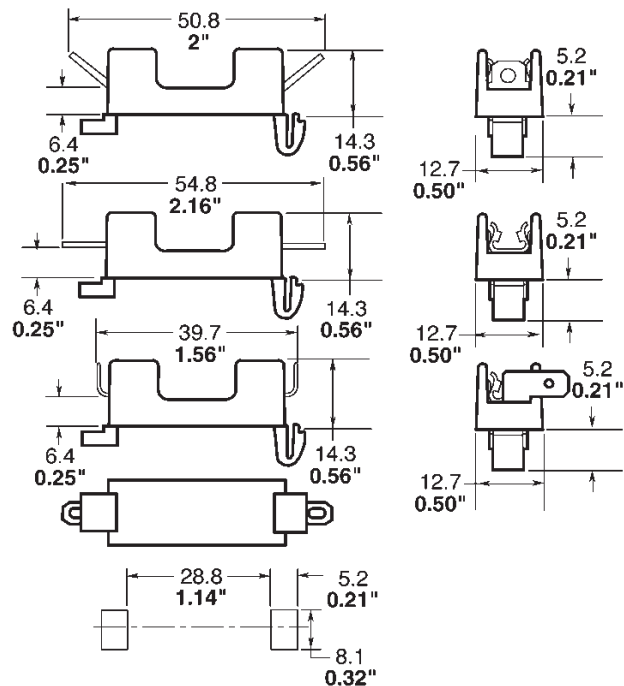

Component	Material
Clip	Spring-Bronze, Bright Tin-Lead Plate
Body	Thermoplastic

PACKAGING CODE	
Packaging Code	Description
Blank	Varies with number of poles. Contact customer service.
BK/	Varies with number of poles. Contact customer service.

Ordering

- Specify packaging, product, and option code

Example: BK/S-8001-01-SNP

<u>BK/</u>	<u>S-8</u>	<u>0</u>	<u>01</u>	-	<u>01</u>	-	<u>SNP</u>	<u>-R</u>
↓	↓	↓	↓		↓		↓	↓
1	2	3	4		5		6	7

- Packaging Code: BK/
- Series Number: S-8
- Type Terminal:
 - 0 = Solder
 - 1 = 3/16" Quick Connect
 - 2 = 1/4" Quick Connect
 - 3 = Screw
- Terminal Angle:
 - 01 = Straight (0°)
 - 02 = 40° Angle
 - 03 = Side*
- Number of Poles: (01 – 12)
- Mounting Style:
 - 1X = One pole, No Mounting Stud
 - SNP = Snap-in Mounting
- RoHS Compliant Version -R

*Available only in single pole

ESD Suppression Selection Guide

Polymer ESD Suppressors

Features:

- Outstanding ESD protection for high frequency, low voltage applications.
- Exceeds testing requirements outlined in IEC 61000-4-2
- Extremely low capacitance
- Very low leakage current
- Fast response time
- Bi-directional
- Surface mount
- Solder Termination

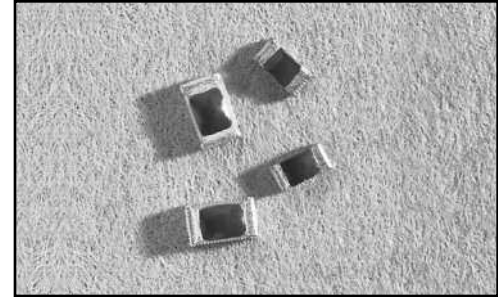

What is it:

Our Voltage Variable Material (VVM) has unique properties that are highly preferred in ESD suppression applications. The polymer matrix responds to an over-voltage condition by rapidly changing from a high impedance state to a low impedance state.

Cooper Bussmann utilizes this polymeric matrix in PolySurg ESD Suppressors for fast response, ultra low capacitance, and very low current leakage. The device is activated by over-voltage threat and clamps to a low value to protect sensitive circuit components.

How it Works:

The PolySurg TR and MLP Series are board level circuit protection devices designed exclusively for the fast, transient over-voltages associated with ESD. When a sufficient over-voltage occurs it exhibits a dramatic increase in the ability to conduct electrons. The nature of the material creates a bi-directional part, which means that only one device is required to provide complete ESD protection regardless of the surge polarity. In a typical application, the device is placed across a signal line leading to an integrated circuit and ground. The device exhibits minimal capacitance

and is “invisible” to the circuit during the normal operation. Under normal operating voltages (typically 3 to 15V) the high impedance of the device insulates each signal line from ground. When an ESD event occurs, the voltage variable material switches to a conductive state within nanoseconds. The voltage across signal line collapses to the clamping level, and current is shunted through the device to the ground. When the overvoltage event ends, the circuit returns to its normal operating state as the device switches back to its $>10^{12}$ Ohm, high resistance state and “invisibility.”

PolySurg™ ESD Suppressor Selection Guide:

Part Number	Package Size	Lines	Operating Voltage (VDC)	Capacitance (pF @ 1KHz ~ 1.8GHz)	Current Leakage (nA @ 12VDC)	Clamp Voltage V	Specification
0402ESDA-MLP7	0402	1	0 ~ 30	< 0.15	< 0.1	35	IEC61000-4-2, Level 4
0603ESDA-MLP7	0603	1	0 ~ 30	< 0.15	< 0.1	35	IEC61000-4-2, Level 4
0603ESDA-TR1	0603	1	0 ~ 24	< 0.15	< 0.1	35	IEC61000-4-2, Level 4

Device Marking

PolySurg™ ESD Suppressors are marked on the tape and reel packages, not individually. Since the product is bi-directional and symmetrical, no orientation marking is required.

Test Methodology

Full product characterization requires use of multiple test methods. Each test method reveals unique information about the device response. The results of all of the tests must be analyzed to fully understand the PolySurg™ ESD Suppressor response to an over-voltage event.

Electrostatic Discharge (ESD) Pulse

The ESD pulse is the defining test for an ESD protective device. The ESD pulse is an extremely fast rising transient event. The pulse, as characterized in IEC 61000-4-2, has a rise time of less than 1ns, peak currents up to 45A, and voltage levels to 15 kV. Characteristics determined by this test are those such as voltage overshoot, peak voltage, clamping voltage, peak current, and device resistance.

Due to the extremely fast rate of rise of the ESD pulse, the test setup can have a definite impact on the above factors. Variables such as wiring inductance and probe capacitance can produce inaccurate readings on an otherwise capable oscilloscope.

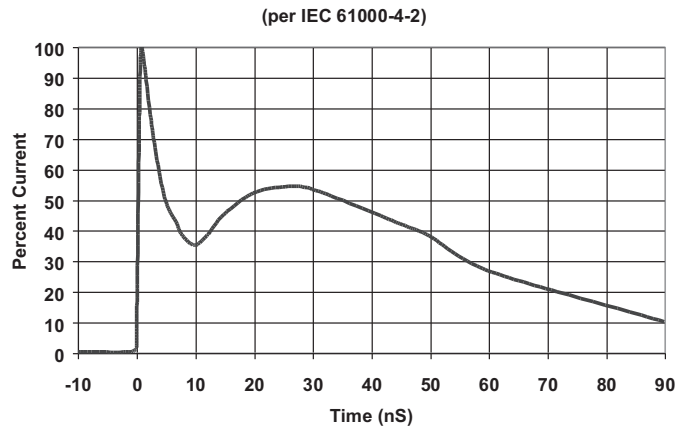

Transmission Line Pulse (TLP)

The Transmission Line Pulse tester implements a controlled impedance cable to deliver a square wave current pulse. The advantage of this technique is that the constant current of the square wave allows the behavior of the protection structure to be more accurately studied.

The actual implementation of this technique produces a waveform that has a slightly slower rise time than the ESD pulse but can be correlated to the deliver approximately the same surge current and energy. This controlled impedance pulse provides a more accurate depiction of the trigger voltage of the device because of the reduced voltage overshoot caused by a fast rising transient and the reactive components of the test fixture.

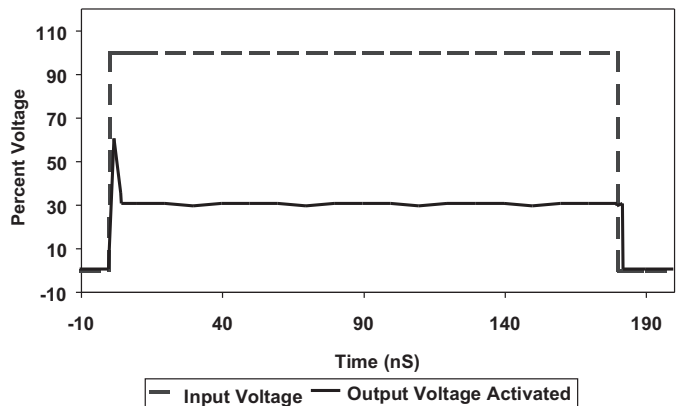

Definition of Terms

Clamp Voltage – The voltage at which the PolySurg™ device stabilizes during the transition from high to low impedance. This is the voltage experienced by the circuit, after stabilizing, for the duration of the ESD transient.

Trigger Voltage – The voltage at which the PolySurg™ device begins to function. When the ESD threat voltage reaches this level, the PolySurg™ device begins the transition from high impedance to low impedance, shunting the ESD energy to ground.

Threat Voltage – The voltage that the test equipment is set to operate (i.e. the voltage across the discharge capacitor).

Peak Current – The maximum instantaneous current level that a device will receive. IEC-61000-4-2 states that the peak current should be 30A at 8kV ESD and 45A at 15kV ESD.

ESD Suppression Selection Guide

Polymer ESD Suppressors

Selected Characterization Data

ESD Transient Pulse Energy Controlled by PolySurg™

Figure 1 shows typical PolySurg™ ESD Suppressor response to an 8 kV contact ESD pulse. Triggered polymer in the device conducts excess energy to ground and prevents system damage by ESD transient threat. As the polymer resistance drops current flows to ground.

The top scope trace indicates current, and the bottom scope trace indicates voltage.

Figure 1. Typical Device Response to 8kV ESD

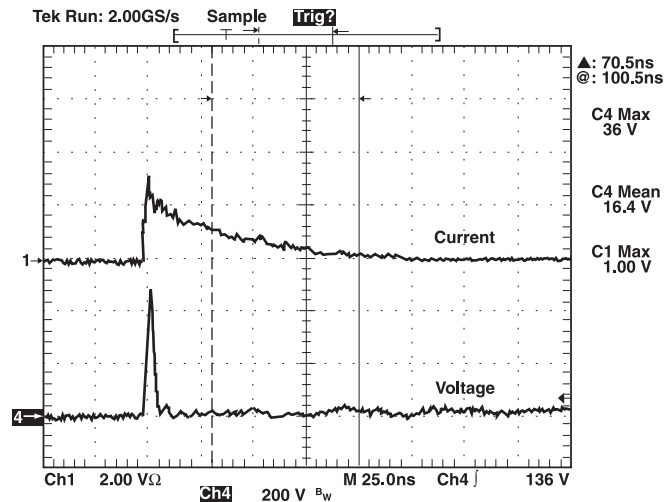

Protects against ESD Voltage Transient without Affecting Signal Quality

PolySurg™ ESD Suppressors have an ultra low capacitance of <math><0.15\text{pF}</math> and when typically installed from the signal line to ground have a negligible effect on the signal.

As Figure 2 shows, the test conducted with a precision network analyzer on a 50 Ω circuit at up to 6GHz. Only a 0.2dB deviation from the original signal was recorded.

The setup was similar to the addition of the PolySurg™ ESD Suppressor to a circuit with very fast digital signal or a cellular phone antenna.

Figure 2. ESDA device induced interference with Signal Quality

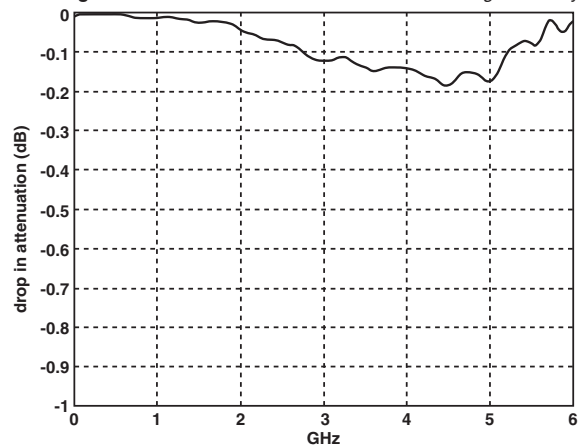

Signal Frequency does not affect the Capacitance of the Device

The device capacitance is very low and constant over wide frequency range. The typical capacitance is less than 0.15pF over the tested range of 0.1MHz to 1.8GHz. In addition, as shown in Figure 3, the capacitance will remain same over the life cycle of the device (i.e. the number of the ESD pulse does not change the device capacitance.)

Figure 3. Capacitance vs. Frequency

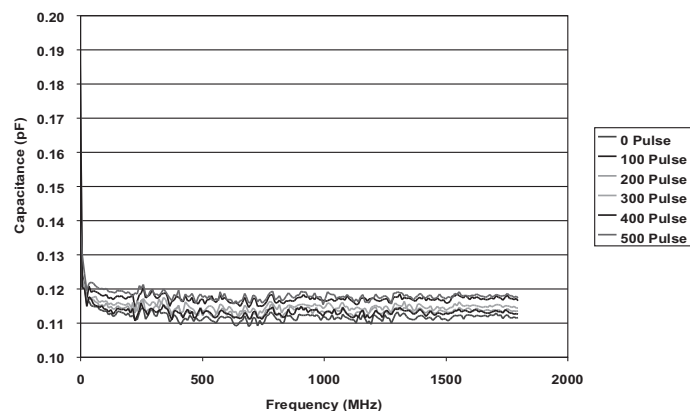

Clamp Voltage Remains Consistent Despite Repeated ESD Pulses

As Figure 4 shows, PolySurg™ ESD Suppressors are highly reliable and stable over hundreds of pulses.

PolySurg™ ESD Suppressors have been tested with fast rate ESD pulses at 8kV contact discharge. Clamping voltage measured at every pulse shows minimal changes throughout the test.

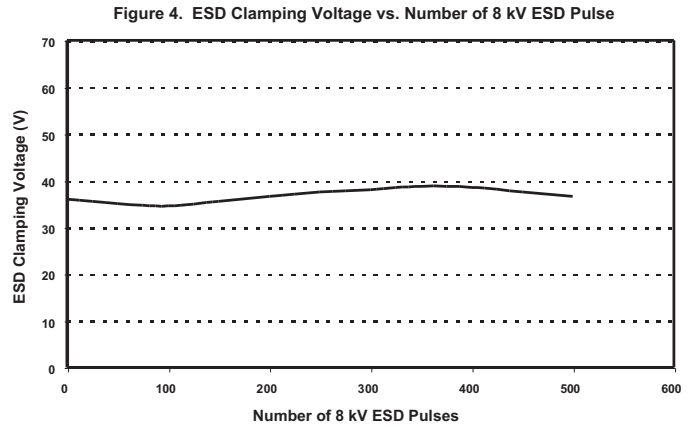

Typical non-triggered (Off State) Current Leakage is Very Low at Normal Operating Voltages and Temperatures

As shown by Figure 5 the current leakage of the PolySurg™ ESD Suppressor is typically very low, well under 1nA, even over 12VDC operating voltage. Some increase in the current leakage may be expected at much higher operating voltage and elevated temperature.

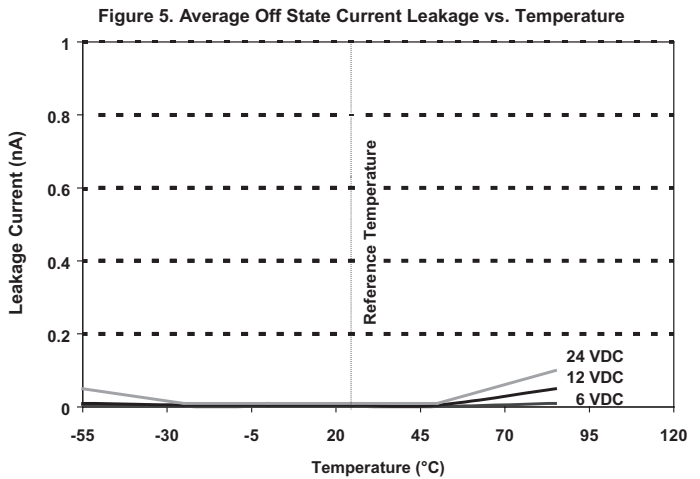

Features & Benefits

- Ultra-low capacitance (0.05pF typ.) ideal for high speed data applications
- Provides ESD protection with fast response time (<1ns) allowing equipment to pass IEC 61000-4-2 level 4 test
- Single-line, bi-directional device for placement flexibility
- Low profile 0402/1005 design for board space savings
- Low leakage current (<0.1nA typ.) reduces power consumption



Applications

- Computers & Peripherals
- HDTV Equipment
- DVD Players
- A/V Equipment
- Satellite Radio
- Cell Phones
- PDA's
- Digital Still Cameras
- Digital Camcorders
- MP3 / Multimedia Players
- Set Top Boxes
- External Storage
- DSL Modems
- High Speed Data Ports
 - USB 2.0
 - IEEE 1394
 - HDMI
 - DVI
 - High Speed Ethernet
 - Infiniband®

Description

The PolySurg™ 0402ESDA-MLP ESD Suppressors protect valuable high-speed data circuits from ESD damage without distorting data signals as a result of its ultra-low (0.05pF typical) capacitance.

Ordering Information

Catalog Number	Packaging
0402ESDA-MLP7	10,000 pieces in paper tape on 7" (178mm) reel
0402ESDA-MLP8	2,500 pieces in paper tape on 7" (178mm) reel

Product Dimensions: mm [inches]

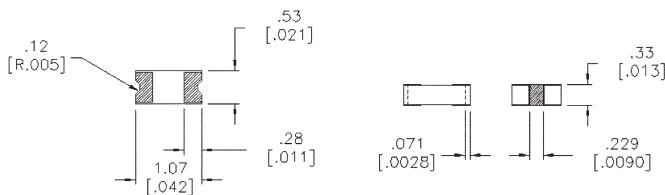

Solder Pad Recommendation: mm [inches]

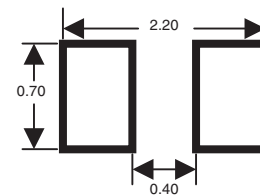

Design Considerations

The location in the circuit for the MLP series has to be carefully determined. For better performance, the device should be placed as close to the signal input as possible and ahead of any other component. Due to the high current associated with an ESD event, it is recommended to use a "0-stub" pad design (pad directly on the signal/data line and second pad directly on common ground).

Electrical Characteristics

Characteristic	Value
Rated Voltage	30VDC maximum
Clamping Voltage ¹	35V typical
Trigger Voltage ²	300V typical
Capacitance (@ 1MHz)	0.05pF typ., 0.15pF max.
Attenuation Change (0-6GHz)	-0.2dB typical
Leakage Current (@ 12VDC)	<0.1nA typical
ESD Capability	
IEC61000-4-2 Direct Discharge	8kV typical
IEC61000-4-2 Air Discharge	15kV typical
ESD Pulse Withstand ¹	>1000 typical

Notes:

1. Per IEC61000-4-2, Level 4 waveform (8kV direct, 30A) measured 30ns after initiation of pulse.
2. Trigger measurement made using Transmission Line Pulse (TLP) method.
3. Minor shifting in characteristics may be observed over multiple ESD pulses at very rapid rate.

Environmental Specifications:

- Load Humidity: 12VDC per EIA/IS-772 Para. 4.4.2, +85°C, 85% RH for 1000 hours
- Thermal Shock: EIA/IS-722 Para 4.6, Air to Air -55°C to +125°C, 5 cycles
- Moisture Resistance Test: MIL-STD-202G Method 106G, 10 cycles
- Mechanical Shock: EIA/IS-722 Para. 4.9
- Vibration: EIA/IS-722 Para. 4.10
- Resistance to Solvent: EIA/IS-722 Para. 4.11
- Operating & Storage Temperature Range: -55°C to +125°C

Soldering Recommendations

- Compatible with lead and lead-free solder reflow processes
- Peak reflow temperatures and durations:
 - IR Reflow = 260°C max for 10 sec. max.
 - Wave Solder = 260°C max. for 10 sec. max.
- Recommended IR Reflow Profile:

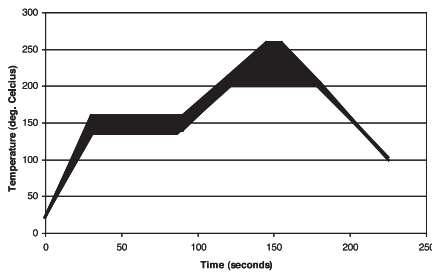

Features & Benefits

- Ultra-low capacitance (0.05pF typ.) ideal for high speed data applications
- Provides ESD protection with fast response time (<1ns) allowing equipment to pass IEC 61000-4-2 level 4 test
- Single-line, bi-directional device for placement flexibility
- Low profile 0603/1608 design for board space savings
- Low leakage current (<0.1nA typ.) reduces power consumption

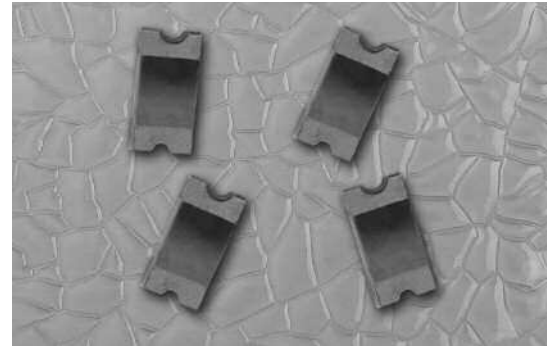

Applications

- Computers & Peripherals
- HDTV Equipment
- DVD Players
- A/V Equipment
- Satellite Radio
- Cell Phones
- PDA's
- Digital Still Cameras
- Digital Camcorders
- MP3 / Multimedia Players
- Set Top Boxes
- External Storage
- DSL Modems
- High Speed Data Ports
 - USB 2.0
 - IEEE 1394
 - HDMI
 - DVI
 - High Speed Ethernet
 - Infiniband®

Description

The PolySurg™ 0603ESDA-MLP ESD Suppressors protect valuable high-speed data circuits from ESD damage without distorting data signals as a result of its ultra-low (0.05pF typical) capacitance.

Ordering Information

Catalog Number	Packaging
0603ESDA-MLP7	5,000 pieces in paper tape on 7" (178mm) reel

Product Dimensions: mm [inches]

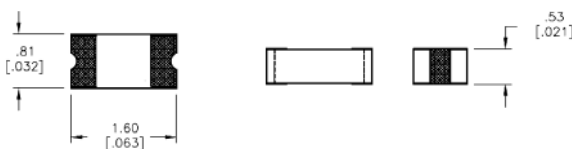

Solder Pad Recommendation: mm [inches]

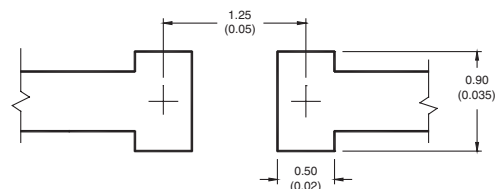

Design Considerations

The location in the circuit for the MLP series has to be carefully determined. For better performance, the device should be placed as close to the signal input as possible and ahead of any other component. Due to the high current associated with an ESD event, it is recommended to use a "0-stub" pad design (pad directly on the signal/data line and second pad directly on common ground).

Electrical Characteristics

Characteristic	Value
Rated Voltage	30VDC maximum
Clamping Voltage ¹	35V typical
Trigger Voltage ²	300V typical
Capacitance (@ 1MHz)	0.05pF typ., 0.15pF max.
Attenuation Change (0-6GHz)	-0.2dB typical
Leakage Current (@ 12VDC)	<0.1nA typical
ESD Capability	
IEC61000-4-2 Direct Discharge	8kV typical
IEC61000-4-2 Air Discharge	15kV typical
ESD Pulse Withstand ¹	>1000 typical

Notes:

1. Per IEC61000-4-2, Level 4 waveform (8kV direct, 30A) measured 30ns after initiation of pulse.
2. Trigger measurement made using Transmission Line Pulse (TLP) method.
3. Minor shifting in characteristics may be observed over multiple ESD pulses at very rapid rate.

Environmental Specifications:

- Load Humidity: 12VDC per EIA/IS-772 Para. 4.4.2, +85°C, 85% RH for 1000 hours
- Thermal Shock: EIA/IS-722 Para 4.6, Air to Air -55°C to +125°C, 5 cycles
- Moisture Resistance Test: MIL-STD-202G Method 106G, 10 cycles
- Mechanical Shock: EIA/IS-722 Para. 4.9
- Vibration: EIA/IS-722 Para. 4.10
- Resistance to Solvent: EIA/IS-722 Para. 4.11
- Operating & Storage Temperature Range: -55°C to +125°C

Soldering Recommendations

- Compatible with lead and lead-free solder reflow processes
- Peak reflow temperatures and durations:
 - IR Reflow = 260°C max for 10 sec. max.
 - Wave Solder = 260°C max. for 10 sec. max.
- Recommended IR Reflow Profile:

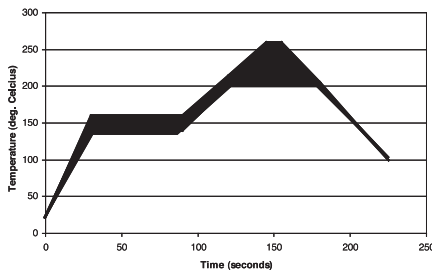

Features:

- 0603/1608 foot print
- Ideal ESD protection for high frequency, low voltage applications.
- Exceeds testing requirements outlined in IEC 61000-4-2
- Ultra low capacitance (0.15pF maximum)
- Very low leakage current
- Fast response time
- Bi-directional
- Surface mount

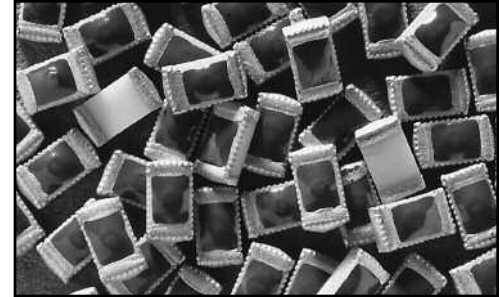

Applications

- Computers & Peripherals
- HDTV Equipment
- DVD Players
- A/V Equipment
- Satellite Radio
- Cell Phones
- PDA's
- Digital Still Cameras
- Digital Camcorders
- MP3 / Multimedia Players
- Set Top Boxes
- External Storage
- DSL Modems
- High Speed Data Ports
 - USB 2.0
 - IEEE 1394
 - HDMI
 - DVI
 - High Speed Ethernet
 - Infiniband®

Description

The PolySurg™ 0603ESDA-TR ESD Suppressors protect valuable high-speed data circuits from ESD damage without distorting data signals as a result of its ultra-low (0.15pF maximum) capacitance.

Ordering Information

Catalog Number	Packaging
0603ESDA-TR1	5,000 pieces in paper tape on 7" (178mm) reel

Part Ratings and Characteristics:

Performance Characteristics	Units	Min	Typ	Max
Continuous operating voltage	VDC	-	-	24
Clamping voltage ²	V	-	35	60
Trigger voltage ³	V	-	125	-
ESD Threat voltage capability ⁴	kV	-	8	15
Capacitance (@ 1 KHz ~ 1.8GHz)	pF	-	-	0.15
Leakage current (@ 12 VDC)	nA	0.01	<0.1	-
Peak current ²	A	-	30	45
Operating temperature	°C	-56	+25	+105
ESD pulse withstand ²	# pulses	20	>500 ¹	-

Notes:

1. Some shifting in characteristics may occur when tested over several hundred ESD pulses at very rapid rate of 1 pulse per second or faster.
2. Per IEC 61000-4-2, 30A @ 8kV, level 4, clamp measurement made 30ns after initiation of pulse, all tests in contact discharge mode.
3. Trigger measurement made using Transmission Line Pulse (TLP) method
4. PolySURG™ devices are capable of withstanding up to a 15 kV, 45A ESD pulse. Device ratings are given at 8kV per Note 1, unless otherwise specified.

Product Dimension

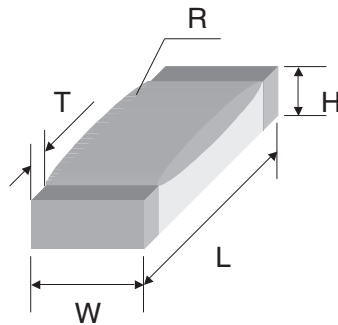

EIA Size mm (in)	L	W	H	T	R
0603ESDA	1.60 ± 0.10 (.063 ± .004)	0.80 ± 0.10 (.031 ± .004)	0.50 ± 0.10 (.020 ± .004)	0.30 ± 0.20 (.012 ± .008)	0.70 ± 0.10 (.028 ± .004)

Recommended Solder Pad Outline
 (per IPC-SM-782)

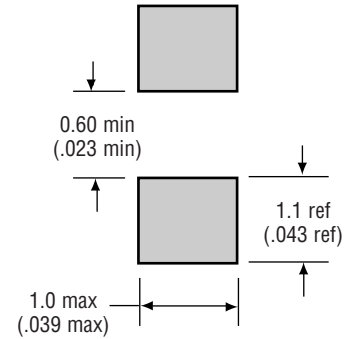

Tape-and-Reel Specification

Dimension	0603
A	1.90±0.20 (.075±0.008)
B	1.10±0.20 (.043±0.008)

Environmental Specifications:

- Moisture Resistance per EIA/IS-722 Paragraph 4.4.2. This standard is based upon MIL-STD-202G Method 103B but with temperature and relative humidity at +85°C and 85% RH respectively. Test condition 'A' (240Hr) per MIL-STD-202G
- Thermal shock: MIL-STD-202, Method 107G, -55°C to 125°C, 30 min. cycle, 10 cycles
- Vibration: MIL-STD-202F, Method 201A, (10 to 55 to 10 Hz, 1 min. cycle, 2 hrs each in X-Y-Z)
- Chemical resistance: ASTM D-543, 4 hrs @ 40°C, 3 solutions (H₂O, detergent solution, defluxer)
- Operating temperature characteristics: measurement at +25°C, +105°C and -56°C
- Full load voltage: 14.4VDC, 18VDC & 24VDC for 1000 hrs, 25°C
- Solder leach resistance and terminal adhesion: Per EIA-576
- Solderability: MIL-STD-202, Method 208 (95% coverage)

Device Marking

PolySurg™ ESD Suppressors are marked on the tape and reel packages, not individually. Since the product is bi-directional and symmetrical, no orientation marking is required.

Design Consideration

The location in the circuit for the TR series has to be carefully determined. For better performance, the device should be placed as close to the signal input as possible and ahead of any other component. Due to the high current associated with an ESD event, it is recommended to use a “0-stub” pad design (pad directly on the signal/data line and second pad directly on common ground).

Processing Recommendations

The TR series currently has a convex profile on the top surface of the part. This profile is a result of the construction of the device. They can be processed using standard pick-and-place equipment. The placement and processing techniques for these devices are similar to those used for chip resistors and chip capacitors.

Soldering Recommendations

- Compatible with lead and lead-free solder reflow processes
- Peak reflow temperatures and durations:
 - IR Reflow = 260°C max for 10 sec. max.
 - Wave Solder = 260°C max. for 10 sec. max.
- Recommended IR Reflow Profile:

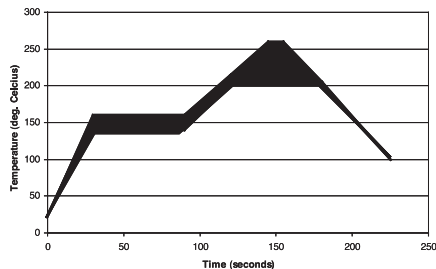

ESD Protection of Set Top Appliances with PolySurg™ ESD Suppressors



What Are Set Top Boxes?

The continuing trend is to link broadband signal delivery to the home entertainment display, and other devices via set top boxes. Set top boxes used to be just an analog cable tuner/decoder but now it includes the likes of digital cable, satellite controller, internet service controllers, digital video recording systems and home networking.

These devices allow the various cable and satellite signal operators to deliver a wide variety of services from television to internet and the hardware manufacturers can provide many features and benefits including home networking capabilities. There is digital video recording onto hard disk drives, replacing the cassette format, allowing pause and replay of and live television, or interactive TV. There are new standards being created to facilitate the design of the boxes such as a recent reference blueprint development by communications chipmaker Broadcom using the Microsoft interactive TV software system. The set top box is going to be a high volume commodity with many forms and functions.

Why are Set Top boxes vulnerable to ESD

The more sophisticated boxes include a variety of I/O jacks such as front panel USB, Audio/Video, S-Video, rear panel Satellite, cable, TV antenna, Wireless transmitter connection, home networking HPNA option, Toslink digital input, connections for CD, DVD, VCR, Outputs for Video, Audio, and more. Most of these jacks are susceptible to ESD threat.

The PolySurg™ solution to the ESD protection problem

Utilize the 0402ESDA-MLP, 0603ESDA-MLP, or 0603ESDA-TR1 PolySurg™ devices to protect the set top box electronics from catastrophic ESD damage at each potential outside metal contact or connector on each line. Audio, Video, RF, USB and RS-232 lines may be protected from ESD TVS occurrences on set top systems.

Design Wins with Set Top boxes

Cooper Bussmann has recorded some notable design wins already with it's PolySurg™ ESD Suppressors in applications involving the protection of set top systems.

Protection Against ESD Threat for Set Top System Input/Output Ports with PolySurg™

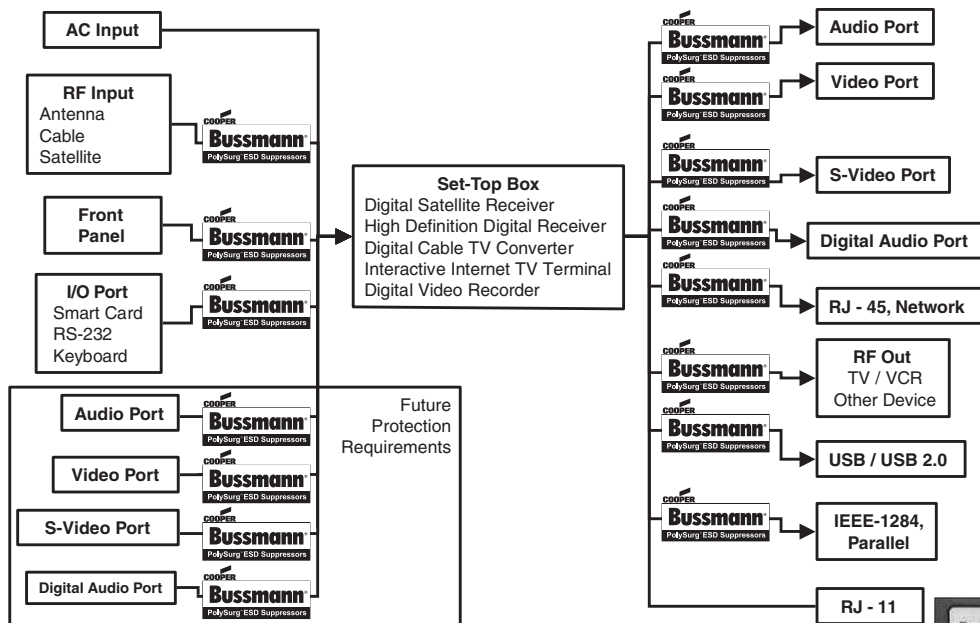

A Typical Set Top Box Rear View



**Typical ESD Protection Applications with
 PolySurg™ 0402ESDA-MLP, 0603ESDA-MLP, or 0603ESDA-TR**

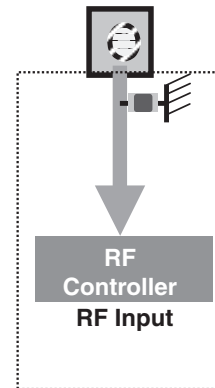
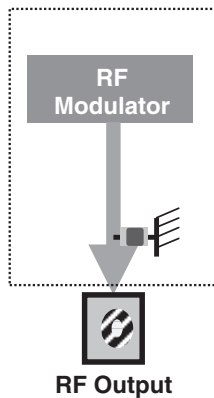
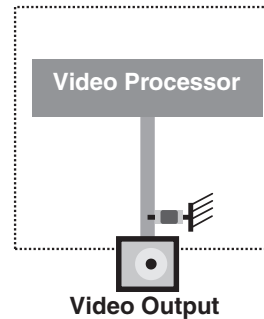
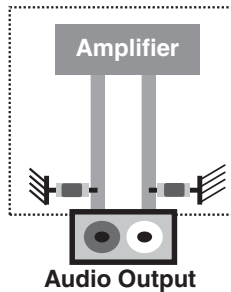
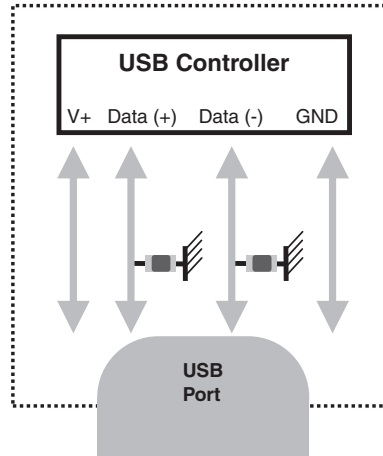

ESD Protection of High-Speed Data Lines

DVI/HDMI High Speed Data Rates

Communication data lines continue to be increasingly vulnerable to ESD transients. The ever-increasing bandwidth of the faster data lines such as the 10/100 or Gigabit Ethernet, USB 2.0, IEEE-1394b, make the traditional ESD protection schemes such as silicon based devices, or multi layer varistors less desirable, due to signal distortion from the relatively high capacitance of these components.

PolySurg™ ESD Suppressors

The typical capacitance of the device (0402ESDA-MLP, 0603ESDA-MLP, or 0603ESDA-TR) is measured to be below 0.15pF, in a range of 0.1 kHz to nearly 2 GHz. The low capacitance throughout this wide frequency range makes these devices suitable for ESD protection of low analog signals to fast digital data lines.

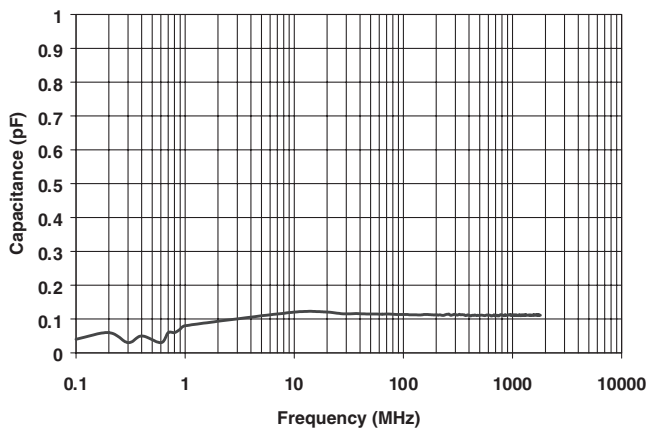

Chart 1. The Capacitance of a PolySurg™ ESD Suppressor from 0.1MHz to 1.8GHz

Another special characteristic of the PolySurg™ ESD Suppressor is that it is virtually invisible to the circuit at normal operation. The off-state resistance of the device is over 10^{13} Ohms, and the typical current leakage of the device is a negligible, 0.01nA at 12VDC. As Chart 2 shows, the additional attenuation in a 50ohm circuit measured at frequencies up to 6GHz is less than -0.2dB.

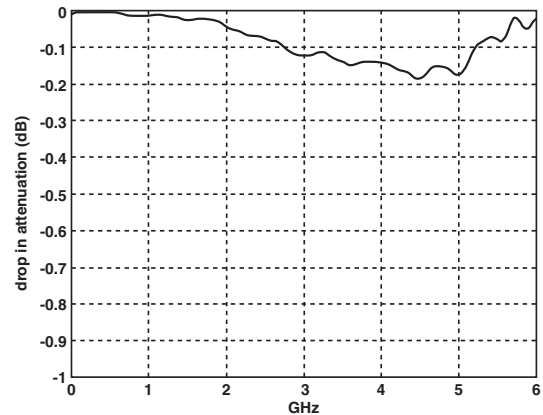

Chart 2. Additional Attenuation in a 50ohm System due to the PolySurg™ ESD Suppressor

Example of devices that PolySurg™ ESD Suppressors can protect from ESD:

- Network interface cards for desktops
- PC cards for laptops
- DSL / Cable modems.
- Routers and switches /hubs

Selected Protection Applications

Ethernet ports: The RJ-45 is the most common Ethernet connection. The typical 10Base-T/100Base-TX uses 4 out of 8 lines. Each line in use can be protected with one PolySurg™ ESD Suppressor installed between the data line and the ground. For the best performance, place the devices at the closest location to the RJ-45 port (See Figure 1)

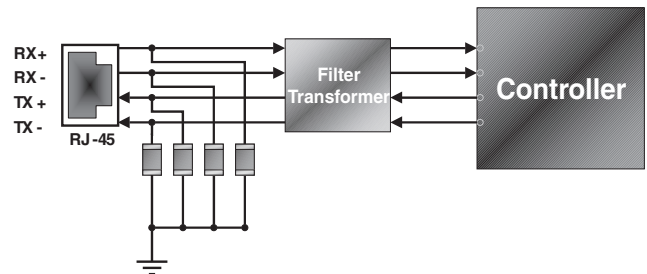

Figure 1. The ESD Protection of 10 / 100 Ethernet (RJ-45) device with a PolySurg™ ESD Suppressor

Firewire: The IEEE-1394 (Firewire) series are the newest serial ports for computer and other instruments with data transfer rates up to 1,600Mbps (1394a is 400Mbps, and 1394b will be 800~1,600Mbps.) This higher transfer speed data is more easily subject to distortion (Chart 3). The PolySurg™ ESD Suppressor can protect data lines from ESD without distorting the high speed signal possible from IEEE-1394 connection. All data lines should be protected individually. (See Figure 2)

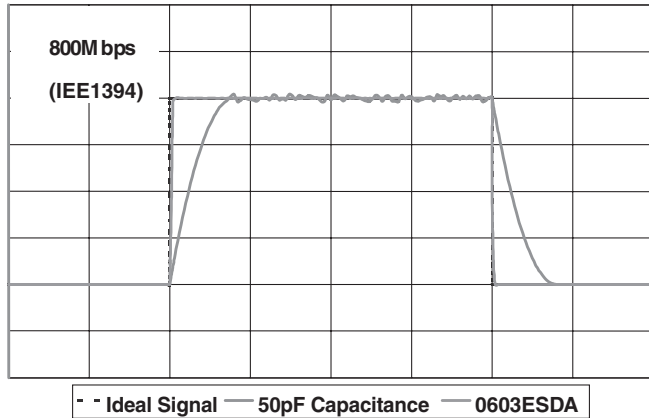

Chart 3. Signal distortion comparisons at 800Mbps

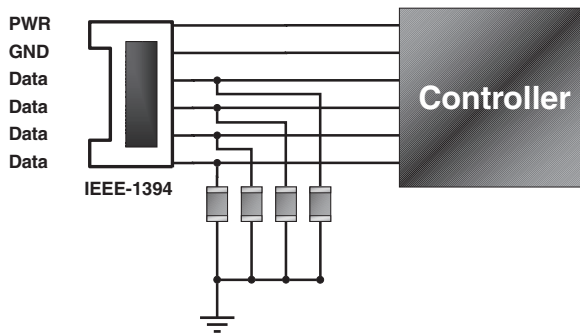

Figure 2. The ESD Protection of Typical IEEE-1394a device with a PolySurg™ ESD Suppressor

Example of devices that PolySurg™ ESD Suppressor can protect from ESD:

- Firewire interface cards
- Digital camcorders
- Printers / scanners
- Other peripherals with Firewire capability

USB 2.0: The USB 2.0 has a fast data transfer rate of 400Mbps. A device equipped with USB 2.0 will give the best performance when protected with the ultra low capacitance PolySurg ESD Suppressor. This will result in much less data distortion than if zener diodes or multi layer varistors are used for ESD protection (See Figure 3)

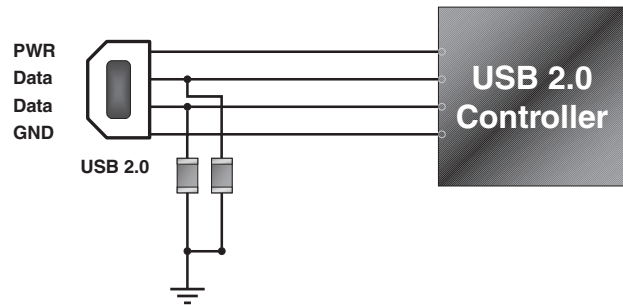

Figure 3. ESD protection of USB 2.0 devices with a PolySurg™ ESD Suppressor

Special Applications

When the unused data port is connected to a higher operating voltage such as 24V or higher for special applications, the PolySurg™ ESD Suppressor can be installed in series for ESD protection on the higher voltage line. The operating voltage capability will be increased without changing total capacitance or the current leakage of the devices.

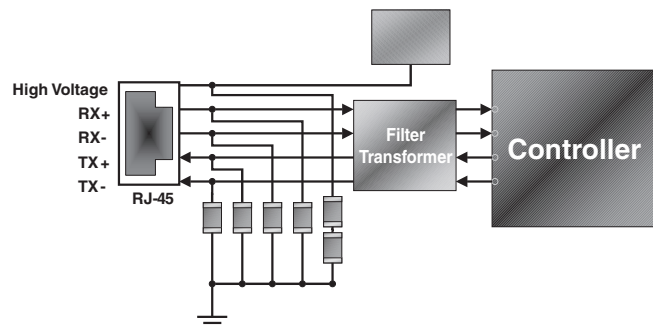

Figure 4. The Parallel connection for high voltage line protection using a PolySurg™ ESD Suppressor on RJ-45

ESD Protection for High Speed Digital Video Solutions (DVI & HDMI)

High speed, uncompressed, digital video solutions such as Digital Visual Interface (DVI) and High Definition Multimedia Interface (HDMI) utilize small geometry CMOS processes in order to provide maximum performance in a small package. However these geometries are more susceptible to electrostatic discharge (ESD) and the high-speed digital signals present a real challenge when selecting an appropriate protection device.

DVI/HDMI High Speed Data Rates

DVI equipment can, currently, transmit at up to 1.6 Gbps for a 1600 x 1200 resolution signal. The receiver end can support up to 1.08 Gbps for 1280 x 1024 resolution but will soon increase to 1.65 Gbps. HDMI is an advancement of DVI that handles both audio and video signals with enough bandwidth for data rates of up to 5 Gbps. These high-speed data rates require any ESD protection device to have low capacitance in order to minimize signal distortion. At high frequency any capacitance will be seen as a low impedance path to ground, thus loading the data signal. Figure 1 shows the minimal effect of a PolySurg™ ESD Suppressor on an 800 Mbps data signal compared to a 50pF capacitor.

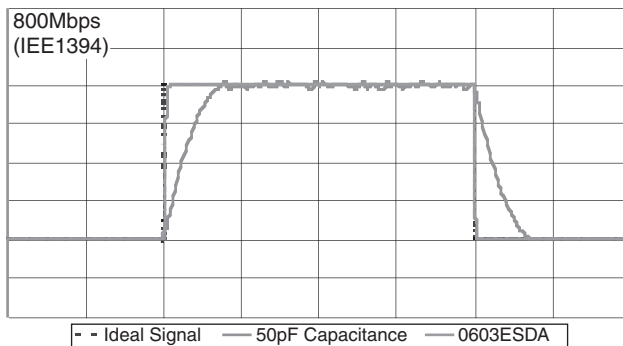

Figure 1 – IEE1394 Signal Distortion due to 50pF and 0603ESDA PolySurg™ ESD Suppressor

Traditional low capacitance steering diode solutions have a number of problems when used in high-speed data applications such as HDMI & DVI. Diodes are typically connected rail to rail as shown in Figure 2. During a negative voltage transient the bottom diode conducts clamping the voltage to a diode drop below ground. During a positive voltage transient the top diode will conduct the surge current (I_1) into the power rail. Dumping the surge current into an unprotected supply rail can cause latch up of the protection circuit, so an additional transient voltage suppression (TVS) device between the supply rail and ground is required.

Typically discrete steering diodes are not rated for the high transient currents associated with ESD. This misuse results in a short cycle life and eventual diode failure, which is commonly in short circuit mode. This short circuit failure mode usually results in the equipment no longer functioning, even though the ESD event has passed. The preferred failure mode is open, since the equipment will certainly not operate with a shorted device, but has a potential to operate longer if the device were to fail open.

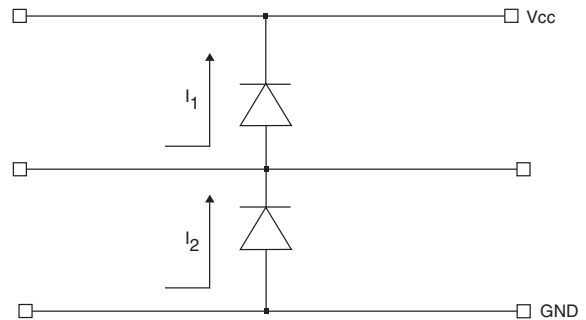

Figure 2 – Rail to Rail Diode Connection

In order to make a low capacitance diode a small junction area is used which presents a high resistance during ESD transients. Also, diode response time is slow compared to the ESD voltage rise time and the complete solution has significant parasitic inductance associated with the device leads and tracking. All this results in a large amount of voltage overshoot and a much higher clamping voltage. With the HDMI/DVI chip still exposed to several hundred or even one thousand volts following an ESD event, using this protection technique, there is potentially enough stress to damage the device.

Other solutions such as zener diodes, multi-layer varistors (MLV's) and TVS all exhibit levels of capacitance that are too large for them to be practical solutions in DVI and HDMI applications. With capacitance values from 25pF to 500pF coupled with leakage currents of 0.5-50μA the level of loading on the signal lines becomes unacceptable.

PolySurg™ ESD Suppressor Product Family

The Cooper Bussmann PolySurg™ ESD Suppressor provides the solution to the problem of providing ESD protection for these new high-speed circuits. This product is a bi-directional device that has leakage current of less than 1nA and capacitance less than 0.15pF. This ultra-low capacitance makes the PolySurg™ ESD Suppressor a viable solution for high data rate protocols like HDMI and DVI. With an insertion loss of less than -0.2dB at frequencies up to 6GHz the PolySurg™ ESD Suppressor is invisible to the circuit, introducing no additional loading or signal distortion.

The PolySurg™ ESD Suppressor product family is comprised of the 0402ESDA-MLP, 0603ESDA-MLP, and 0603ESDA-TR series ESD suppression devices. All are discrete devices exhibiting ultra-low capacitance to maintain signal integrity while protecting all but the most sensitive IC's from the harmful effects of ESD strikes up to 15kV (air discharge).

Summary

Commercial products require ESD surge protection of all the interface hardware schemes. New higher end consumer electronics are increasingly using high data rate protocols such as DVI and HDMI. The traditional protection devices have all been used with varying success, however the increase in data rates now indicates a need for ultra low capacitance devices, such as Cooper Bussmann's PolySurg™ ESD Suppressors.